

Application Guidelines

Copeland™ Scroll Compressors for Refrigeration Applications YB12K1E to YB45K1E



About these guidelines	1
1 Safety instructions	1
1.1 Icon explanation	1
1.2 Safety statements	2
1.3 General instructions	2
2 Product description	3
2.1 Compressor range	3
2.2 Nomenclature.....	3
2.3 BOM variations	4
2.4 Application range	4
2.4.1 Qualified refrigerants and oils	4
2.4.2 Application limits.....	4
2.4.3 PED category and maximum allowable pressure PS	5
2.5 Dimensions	6
3 Installation	7
3.1 Compressor handling.....	7
3.1.1 Transport and storage	7
3.1.2 Positioning and securing	7
3.1.3 Installation location.....	7
3.2 Mounting parts	8
3.3 Brazing procedure.....	8
3.3.1 General brazing procedure.....	9
3.3.2 Brazing procedure for YB*K1E compressors in parallel applications	9
3.4 Pressure safety controls	10
3.4.1 High-pressure protection	10
3.4.2 Low-pressure protection.....	10
3.5 System protection for operation below atmospheric pressure.....	10
3.6 Crankcase heater.....	11
3.7 Discharge gas temperature protection.....	12
3.7.1 Excessive discharge gas temperatures	12
3.7.2 Discharge line thermostat.....	13
3.8 Internal pressure relief valve.....	14
3.9 Discharge check valve	14
3.10 Filter screens	14
3.11 Mufflers	14
3.12 Sound shell	14
3.13 Insulation material.....	14
3.14 Sound and vibration	15
3.15 Compressor oil return, oil balancing, refrigerant floodback and oil dilution tests	15

3.16	Suction line accumulator	16
4	Electrical connection	17
4.1	General recommendations	17
4.2	Electrical installation	17
4.3	Terminal box	19
4.4	Motor insulation	20
4.5	Motor protection	20
4.6	High-potential testing	20
5	Start-up & operation	21
5.1	Strength-pressure test	21
5.1.1	<i>Compressor strength-pressure test</i>	21
5.1.2	<i>System strength-pressure test</i>	21
5.2	Compressor tightness test	22
5.3	System evacuation	22
5.4	Preliminary checks – Pre-starting	22
5.5	Charging procedure	23
5.6	Run-in time	23
5.7	Initial start-up	23
5.8	Rotation direction	23
5.9	Starting sound	24
5.10	Deep vacuum operation	24
5.11	Shell temperature	24
5.12	Pumpdown cycle	24
5.13	Minimum run time	25
5.14	Shut-off sound	25
5.15	Supply frequency and voltage	25
5.16	Oil level	25
6	Maintenance & repair	26
6.1	Qualification of workers	26
6.2	Preparation and work procedure	27
6.3	Disassembling system components	27
6.4	Replacing a compressor	27
6.4.1	<i>Compressor replacement</i>	27
6.4.2	<i>Start-up of a new or replacement compressor</i>	28
6.4.3	<i>Compressor return procedure</i>	28
6.5	Exchanging the refrigerant	29
6.6	Lubrication and oil removal	29
6.7	Oil additives	30
7	Dismantling & disposal	31
8	References	31

Appendix 1: Tightening torques 32
DISCLAIMER 32

About these guidelines

The purpose of these guidelines is to provide guidance in the application of Copeland™ scroll compressors in users' systems. They are intended to answer the questions raised while designing, assembling and operating a system with these products.

Besides the support they provide, the instructions listed herein are also critical for the proper and safe functioning of the compressors. The performance and reliability of the product may be impacted if the product is not used according to these guidelines or is misused.

These application guidelines cover stationary applications only. For mobile applications, please contact the Application Engineering department at Emerson as other considerations may apply.

1 Safety instructions

Copeland scroll compressors are manufactured according to the latest relevant European, UK and US safety standards. Particular emphasis has been placed on the user's safety.

YB*K1E compressors are intended for installation in systems in accordance with the following directives and regulations:

Machinery Directive MD 2006/42/EC	Supply of Machinery (Safety) Regulation 2016
Pressure Equipment Directive PED 2014/68/EU	Pressure Equipment (Safety) Regulation 2008
Low Voltage Directive LVD 2014/35/EU	Electrical Equipment (Safety) Regulation 2016

They may be put to service only if they have been installed in systems according to instructions and conform to the corresponding provisions of the applicable legislation.









NOTE: Only dedicated compressors are allowed to be used with flammable refrigerants. Emerson marks all compressors that are qualified for flammable refrigerants with a sticker indicating the usage of such refrigerants. Systems using flammable refrigerants must be executed correctly while observing safety rules, as specified in corresponding safety standards such as, but not limited to EN 378. They must comply with any and all applicable legislation and regulations. Ensuring compliance remains the user's responsibility.

The Material Safety Datasheet (MSDS) of each individual refrigerant shall be considered when working with these types of refrigerants – please check the document provided by the gas supplier.

These instructions shall be retained throughout the lifetime of the compressor.

You are strongly advised to follow these safety instructions.

1.1 Icon explanation

 WARNING This icon indicates instructions to avoid personal injury and material damage.	 Fire hazard This icon indicates a risk of flammable atmosphere.
 High voltage This icon indicates operations with a danger of electric shock.	 CAUTION This icon indicates instructions to avoid property damage and possible personal injury.
 Danger of burning or frostbite This icon indicates operations with a danger of burning or frostbite.	 IMPORTANT This icon indicates instructions to avoid malfunction of the compressor.
 Explosion hazard This icon indicates operations with a danger of explosion.	NOTE This word indicates a recommendation for easier operation.
 Danger of explosive atmosphere This icon indicates a risk of explosive atmosphere.	

1.2 Safety statements

- Refrigerant compressors must be employed only for their intended use. The system has to be labelled according to the applicable standards and legislation.
- Only qualified and authorized RACHP (refrigeration, air conditioning and heat pump) personnel are permitted to install, commission and maintain this equipment.
- Electrical connections must be made by qualified electrical personnel.
- All valid standards for connecting electrical and refrigeration equipment must be observed.
- The national legislation and regulations regarding personnel protection must be observed.

NOTE: For systems using A1 refrigerants (R404A, R407A, R407F, R448A and R449A) the flammable refrigerant sticker is not of application and should be removed from the compressor.

Additional requirements and statements for A2L-refrigerant compressors/systems:

- Only competent personnel (as specified in EN 13313) qualified for flammable refrigerant handling are permitted to commission, initiate and maintain the compressor/refrigeration systems using flammable refrigerant; non-trained personnel, including the user, are not allowed to do so and must call on an expert.
- When planning and building systems with such refrigerants, a risk assessment and corresponding precautions for risk mitigation must be taken by the system designer. Special attention must be paid to flammability when dealing with A2L refrigerants.
- The maximum refrigerant charge is specified in standards such as, but not limited to EN 378, EN 60335-2-40 and EN 60335-2-89. The system designer shall implement all safety measures defined by the applicable standards and the maximum refrigerant charge shall not be exceeded.
- If a flammable atmosphere is detected, immediately take all necessary precautions to mitigate the risk as determined in the risk assessment.



Use personal safety equipment. Safety goggles, gloves, protective clothing, safety boots and hard hats should be worn where necessary.

1.3 General instructions



WARNING

Pressurized system! Serious personal injuries and/or system breakdown! Accidental system start before complete set-up must be avoided. Never leave the system unattended without locking it out electrically when it is under vacuum and has no refrigerant charge, when it has a holding charge of nitrogen, or when the compressor service valves are closed.



WARNING

System breakdown! Personal injuries! Only approved refrigerants and refrigeration oils must be used.



WARNING

High shell temperature! Burning! Do not touch the compressor and piping until they have cooled down. Ensure that other materials in the area of the compressor do not come into contact with it. Lock and mark accessible sections.



CAUTION

Overheating! Bearing damage! Do not operate compressor without refrigerant charge or without it being connected to the system.



CAUTION

Contact with refrigerant oil! Material damage! Polyolester (POE) lubricants must be handled carefully and the proper protective equipment (gloves, eye protection, etc.) must be used at all times. Refrigerant oil must not come into contact with any surface or material that it might damage, including, without limitation, some polymers, eg, PVC/CPVC and polycarbonate.



IMPORTANT

Transit damage! Compressor malfunction! Use original packaging. Avoid collisions and tilting.

2 Product description

2.1 Compressor range

These application guidelines cover Copeland scroll compressor models YB*K1E for medium temperature refrigeration applications. YB*K1E scroll compressors can be operated with either A1 or A2L refrigerants.

Compressor	Cooling capacity* (kW)									Motor
	R404A	R407A	R407F	R448A	R449A	R407C	R513A	R134a	R450A	
YB12K1E	3.15	3.1	3.36	3.17	3.17	2.87	2.02	1.9	1.64	PFZN**/TFDN
YB17K1E	4.41	4.34	4.71	4.44	4.44	4.05	2.85	2.64	2.28	PFZN**/TFDN
YB21K1E	5.62	5.53	6	5.66	5.66	5.15	3.63	3.36	2.9	PFZN**/TFDN
YB24K1E	6.28	6.18	6.71	6.33	6.33	5.75	4.06	3.91	3.36	PFZN**/TFDN
YB31K1E	7.92	7.79	8.45	7.98	7.98	7.29	5.14	4.89	4.21	TFDN
YB36K1E	9.45	9.28	10.1	9.52	9.52	8.62	6.09	5.82	5.01	TFDN
YB45K1E	11.90	11.65	12.65	11.95	11.95	10.90	7.70	7.32	6.32	TFDN

* Refrigerant dew temperature, evaporating temperature: -10 °C; condensing temperature: 45 °C; suction gas superheat: 10 K; liquid sub-cooling: 0 K; frequency: 50 Hz

** Single-phase models are released for use with R407C and R134a refrigerants only.

Table 1: YB*K1E model overview for MT applications with A1 refrigerants

Compressor	Cooling capacity* (kW)				Motor
	R454C	R455A	R454A	R1234yf	
YB12K1E	2.76	2.93	3.31	1.84	PFZN**/TFDN
YB17K1E	3.89	4.15	4.64	2.6	PFZN**/TFDN
YB21K1E	4.92	5.22	5.91	3.29	PFZN**/TFDN
YB24K1E	5.55	5.88	6.6	3.71	PFZN**/TFDN
YB31K1E	6.95	7.4	8.32	4.67	TFDN
YB36K1E	8.23	8.78	9.93	5.47	TFDN
YB45K1E	10.40	11.10	12.50	7.00	TFDN

* Refrigerant dew temperature, evaporating temperature: -10 °C; condensing temperature: 45 °C; suction gas superheat: 10 K; liquid sub-cooling: 0 K; frequency: 50 Hz

** Single-phase models are released for use with R454C refrigerant only.

Table 2: YB*K1E model overview for MT applications with A2L refrigerants

2.2 Nomenclature

The model designation contains the following technical information about the compressor:

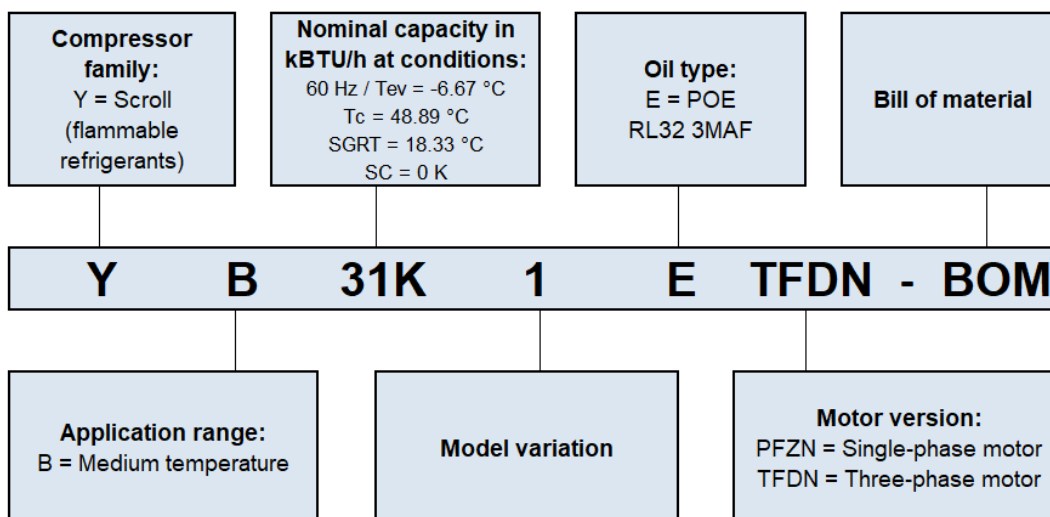

Figure 1: Nomenclature

2.3 BOM variations

The BOM (bill of material) marking at the end of the compressor designation indicates the different compressor layouts and details. YB*K1E compressors are available in the following BOM versions:

BOM	Suction and discharge connections	T-Box	Mounting parts	Features
GBS	Brazing stub tubes	IP54	Without	Single compressor
GCG				Extra tube for paralleling

Table 3: BOM designation

Please refer to the Emerson price list for more details.

2.4 Application range

2.4.1 Qualified refrigerants and oils

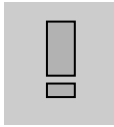

IMPORTANT

Some refrigerant blends have a significant temperature glide. It is essential that the glide of the refrigerant blends be carefully considered when adjusting pressure and superheat controls.

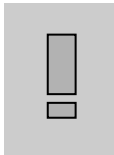

IMPORTANT

Refrigerant blends with low GWP containing HFO's have a low chemical stability in presence of air or humidity. The same levels of cleanliness, dryness and evacuation of the refrigerant circuit are required as in HFC & POE applications, including the use of filter-dryers.

NOTE: R454C, R455A, R454A and R1234yf are classified as A2L (mildly flammable) refrigerants.

Compressors	YB12K1E to YB45K1E*
Qualified refrigerants	R454C, R455A, R454A, R1234yf R404A, R407A, R407F, R448A, R449A, R407C, R513A, R134a & R450A
Qualified oil (factory charged)	RL32 3MAF
Servicing oil	RL32 3MAF

* Single-phase models are released for use with R454C, R407C and R134a refrigerants only.

Table 4: Qualified refrigerants and oil

Oil recharge values can be taken from the compressor nameplate or from Copeland Select software available at www.climate.emerson.com/en-gb.

2.4.2 Application limits



CAUTION

Inadequate lubrication! Compressor breakdown! The superheat at the compressor suction inlet must always be sufficient to ensure that no refrigerant droplets enter the compressor. For a typical evaporator-expansion valve configuration a minimum stable superheat of at least 5 K is required.

For application envelopes and technical data, please refer to Copeland Select software available at www.climate.emerson.com/en-gb.

2.4.3 PED category and maximum allowable pressure PS

The nameplate of the compressor contains information about the maximum allowable pressure PS, the minimum and maximum allowed temperature TS, the internal free volume and the fluid groups of the refrigerants qualified for the compressor model range. Values are given for the two existing pressure ranges on low- and high-pressure sides.

Compressor	PS Low-pressure side	PS High-pressure side	TS max. Low-pressure side	Internal free volume LP side (litres)	Internal free volume HP side (litres)
YB12K1E	23.5 bar(g)	38 bar(g)	50 °C	4.1	0.5
YB17K1E	23.5 bar(g)	38 bar(g)	50 °C	4.2	0.5
YB21K1E	23.5 bar(g)	38 bar(g)	50 °C	4.3	0.5
YB24K1E	23.5 bar(g)	38 bar(g)	50 °C	4.8	0.5
YB31K1E	23.5 bar(g)	38 bar(g)	50 °C	6.4	0.6
YB36K1E	23.5 bar(g)	38 bar(g)	50 °C	6.4	0.6
YB45K1E	23.5 bar(g)	38 bar(g)	50 °C	6.4	0.6

Table 5: Maximum allowable pressures, temperatures and internal free volumes

The PED category is assigned according to the Pressure Equipment Directive PED 2014/68/EU. Requirements apply to the relevant pressure levels in the compressor when the product of "pressure relative to the environment" by "related internal free volume" ($P \times V$) exceeds given limits. When calculating the PED category, the high- and low-pressure sides have to be calculated separately. The highest of the calculation results is considered.

Additionally, a distinction must be made between refrigerants of fluid group 1 (flammable) and fluid group 2 (non-flammable). The YB*K1E compressors covered in these guidelines can be operated with either A1 or A2L refrigerants. Consequently, identical compressor models may be subject to different PED categories depending on the refrigerant used.

Compressor range	Refrigerant	Fluid group	PED category
YB12K1E to YB45K1E	R454C, R455A, R454A, R1234yf	1	II
	R404A, R407A, R407F, R448A, R449A, R407C, R513A, R134a, R450A	2	I

Table 6: PED category based on refrigerant used and fluid group

2.5 Dimensions

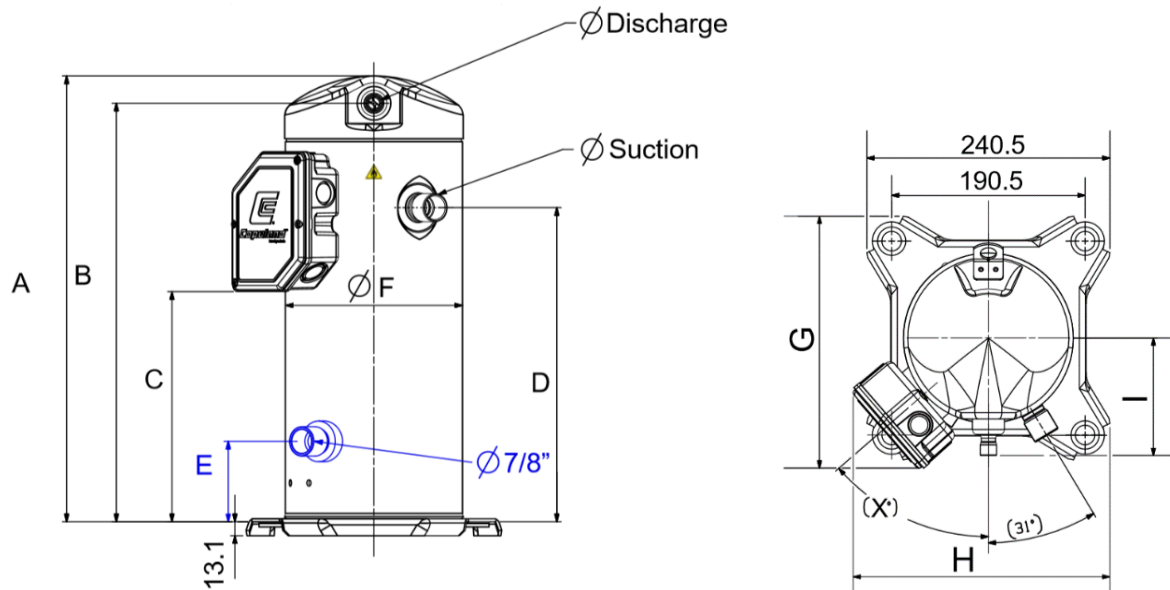

Figure 2

Compressor	A ± 3.0 (mm)	B (mm)	C ± 3.0 (mm)	D (mm)	E (mm)	Ø F (mm)	G (mm)	H (mm)	I (mm)	X (°)
YB12K1E	364.6	338.5	165.8	244.5	69.6	165.8	247.5	252.8	115.5	49
YB17K1E	387.2	361.1	185.7	264.4	75.3	165.8	247.5	252.8	115.5	49
YB21K1E	400.9	374.9	198.4	277.1	75.3	165.8	247.5	252.8	115.5	49
YB24K1E	418	391.9	215.4	294.1	75.3	165.8	247.5	252.8	115.5	49
YB31K1E	442	409.6	225.2	296.7	79.6	185.5	260.5	254.9	124.7	44
YB36K1E	442	409.6	225.2	296.7	79.6	185.5	260.5	254.9	124.7	44
YB45K1E	442	409.6	225.2	296.7	79.6	185.5	260.5	254.9	124.7	44

Table 7: Dimensions of YB*K1E compressors

Compressor	Suction (inch)	Discharge (inch)
YB12K1E	3/4"	1/2"
YB17K1E	3/4"	1/2"
YB21K1E	3/4"	1/2"
YB24K1E	7/8"	1/2"
YB31K1E	7/8"	1/2"
YB36K1E	7/8"	1/2"
YB45K1E	7/8"	1/2"

Table 8: Connection sizes of YB*K1E compressors

NOTE: The connection in blue colour is an additional connection for paralleling models (BOM version GCG).

3 Installation



WARNING
High pressure! Injury to skin and eyes possible! Be careful when opening connections on a pressurized item.

3.1 Compressor handling

3.1.1 Transport and storage



WARNING
Risk of collapse! Personal injuries! Move compressors only with appropriate handling equipment according to weight. Keep in the upright position. Respect stacking loads according to **Figure 3**. Check the tilting stability and if needed take action to ensure the stability of the stacked loads. Keep the packaging dry at all times.



Respect the maximum number of identical packages which may be stacked on one another, where "n" is the limiting number:

- **Transport: n = 1**
- **Storage: n = 2**

Figure 3: Maximum stacking loads for transport and storage

The compressor tilt angle should not exceed 30° during transport and handling. This will prevent oil from exiting through the suction stub. A tilt angle of maximum 45° is allowed for a very short time. Tilting the compressor more than 45° might affect its lubrication at start-up.

NOTE: The compressor is pre-charged with dry air to avoid any moisture contamination.

3.1.2 Positioning and securing

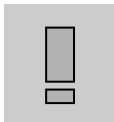

IMPORTANT
Handling damage! Compressor malfunction! Only use the lifting eyes whenever the compressor requires positioning. Using discharge or suction connections for lifting may cause damage or leaks.

The compressor should be kept vertical during handling.

The discharge connection plug should be removed first before pulling the suction connection plug to allow the dry air pressure inside the compressor to escape. Pulling the plugs in this sequence prevents oil mist from coating the suction tube making brazing difficult. The copper-coated steel suction tube should be cleaned before brazing.

The plugs must be removed as late as possible before brazing so that the air humidity does not affect the oil characteristics.

For YB*K1E compressors, as oil might spill out of the suction connection located low on the shell, the suction connection plug must be left in place until the compressor is set into the unit.

No object, eg, a swaging tool should be inserted deeper than 51 mm into the suction tube as it might damage the suction screen and motor.

3.1.3 Installation location

Ensure the compressors are installed on a solid level base. For single-compressor applications, the compressor tilt angle during operation should not exceed 15° to allow adequate lubrication. For multiple-compressor parallel configurations, the compressors must be positioned completely vertically on a totally horizontal surface or rail.

3.2 Mounting parts

The compressors are designed to be mounted on vibration absorber grommets. The grommets dampen the start-up surge of the compressor and minimise sound and vibration transmission to the compressor base during operation. The metal sleeve inside is a guide designed to hold the grommet in place. It is not designed as a load-bearing member, and application of excessive torque to the bolts can crush the sleeve. Its inner diameter is approximately 8.5 mm to fit, eg, an M8 screw. The mounting torque should be 13 ± 1 Nm. It is critically important that the grommet is not compressed.

If the compressors are mounted in tandem or used in parallel, then the hard mountings (bolt M8) are recommended. The mounting torque should be 27 ± 1 Nm.

See Copeland spare parts & accessories catalogue for reference.

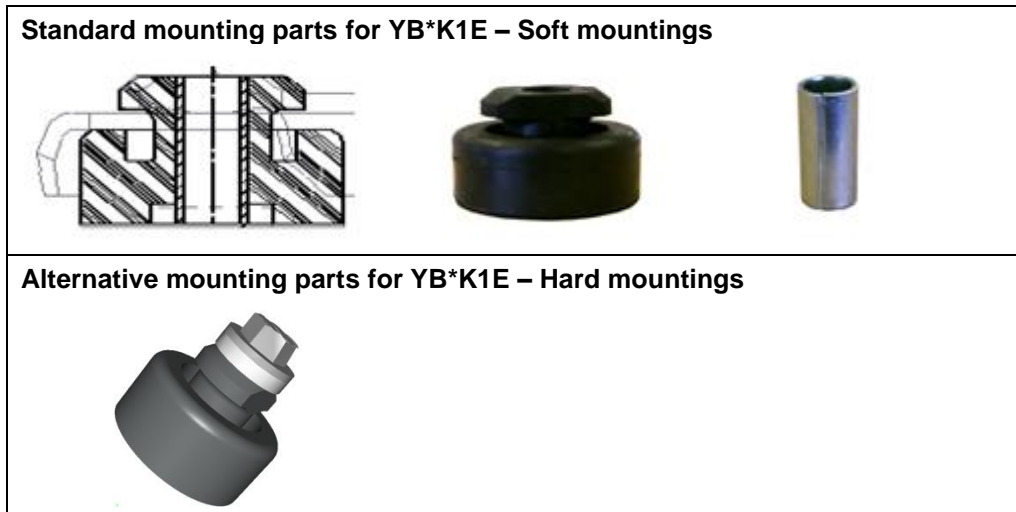

Figure 4: Mounting parts

3.3 Brazing procedure



WARNING

Air/flamable refrigerant mixture! Creation of a potentially flammable atmosphere! Fire hazard! Remove all refrigerant before opening the system. When working on a refrigerant-filled system, make sure to follow the safety and working instructions given in **Chapter 6 "Maintenance & repair"**.



WARNING

High temperature! Burning! Proceed with caution when brazing system components. Do not touch the compressor until it has cooled down. Ensure that other materials in the area of the compressor do not come into contact with it.



CAUTION

Blockage! Compressor breakdown! Maintain a flow of oxygen-free nitrogen through the system at very low-pressure during brazing. Nitrogen displaces the air and prevents the formation of copper oxides in the system. If allowed to form, the copper oxide material can later be swept through the system and block screens such as those protecting capillary tubes, thermal expansion valves, and accumulator oil return orifices.

Contamination or moisture! Bearing failure! Do not remove the connection plugs until the compressor is set into the unit. This minimises any entry of contaminants and moisture.

3.3.1 General brazing procedure

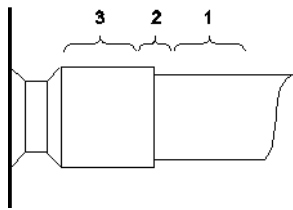

Figure 5: Brazing areas

Copeland scroll compressors have copper-plated steel suction and discharge stub tubes. These stub tubes are far more robust and less prone to leaks than copper tubes. Due to the different thermal properties of steel and copper, brazing must be carried out in an appropriate manner.

Refer to **Figure 5** and procedure below for the brazing of the stub tube connections of a scroll compressor.

- Flushing oxygen-free nitrogen through the piping during the brazing process is recommended for applications with A1 refrigerants and mandatory for applications with flammable A2L refrigerants.
- The copper-coated steel tubes on scroll compressors can be brazed in approximately the same manner as any copper tube.
- Recommended brazing materials: any Silfos material is recommended, preferably with a minimum of 5 % silver. However, 0 % silver is acceptable.
- Be sure tube fitting inner diameter and tube outer diameter are clean prior to assembly.
- Using a double-tipped torch, apply heat in area 1.
- As the tube approaches brazing temperature, move the torch flame to area 2.
- Heat area 2 until braze temperature is attained, moving the torch up and down and rotating around the tube as necessary to heat the tube evenly. Add braze material to the joint while moving the torch around the joint to flow braze material around the circumference.
- After the braze material flows around the joint, move the torch to heat area 3. This will draw the braze material down into the joint. The time spent heating area 3 should be minimal.
- As with any brazed joint, overheating may be detrimental to the final result.

NOTE: Since the discharge stub contains a check valve, care must be taken not to overheat it to prevent brazing material from flowing into it.

3.3.2 Brazing procedure for YB*K1E compressors in parallel applications



WARNING

Air/flammable refrigerant mixture! Creation of a potentially flammable atmosphere! Fire hazard! Remove all refrigerant before opening the system. When working on a refrigerant-filled system, make sure to follow the safety and working instructions given in **Chapter 6 "Maintenance & repair"**.

Only compressor models officially approved by Emerson in the qualified configuration may be used for parallel applications. For YB*K1E compressors in parallel applications with passive oil management, additional precautions shall be taken before brazing the oil and gas equalization ports. The sequence shall be as follows:

First, install the compressors on the base frame and tilt the assembly so that oil will not be lost when opening the cap. The gas and oil equalization line assembly should be ready for brazing at this point. For new compressors, release the protective gas charge: the rubber plug from the discharge port of the compressor has to be removed first, then the rubber plug from the oil port.

Most probably the oil port will be coated with some oil. It is mandatory to clean out the oil before brazing. If the inner surface is contaminated with oil the brazing material will not adhere to the surface and the joint will fail, generating leakage. The oil should be carefully wiped out with industrial absorption paper. Industrial solvents on a clean cloth can be used too but only with great care. Note that emery cloth will not remove the oil.

It is possible that the oil cannot be completely cleaned out. In this case additional measures should be taken. For instance, if a connection is coated with flux then the residual oil will be removed when brazing thanks to the applied heat.

If an active oil level control is to be used, eg, OM* TraxOil from Alco Controls, please refer to the product documentation when brazing the connection adaptor.

3.4 Pressure safety controls

3.4.1 High-pressure protection

Applicable regulations and standards, for example EN 378-2, shall be followed to apply appropriate control and ensure that the pressure never exceeds the maximum limit.

High-pressure protection is required to stop the compressor operating outside the allowable pressure limits. The high-pressure control must be installed correctly, which means that no service valve is allowed between the compressor and the pressure protection.

The high-pressure cut-out setting shall be determined according to the applicable standard, the type of system, the refrigerant and the maximum allowable pressure PS.

3.4.2 Low-pressure protection



CAUTION

Operation outside the application envelope! Compressor breakdown! A low-pressure protection shall be fitted in the suction line to stop the compressor when it operates outside the envelope limits. Do not bridge or bypass the low-pressure limiter.

Applicable regulations and standards shall be followed to apply appropriate control and ensure that the pressure is always above the required minimum limit.

Low-pressure protection is required to stop the compressor operating outside the allowable envelope limits. The low-pressure control must be installed correctly into the suction line, which means that no service valve is allowed between the compressor and the pressure protection.

The minimum cut-out setting shall be determined according to the refrigerant and the allowed operation envelope – see Select software at www.climate.emerson.com/en-gb/tools-resources.

3.5 System protection for operation below atmospheric pressure



WARNING

Operation below atmospheric pressure! Fire hazard! During operation below atmospheric pressure, a flammable mixture can form inside the system. Ensure system tightness to prevent any ingress of air.

YB*K1E compressors used in R454C, R455A, R454A and R1234yf systems could be operated below atmospheric pressure. In that case special requirements for safety and tightness apply and the following precautions must be observed:

- Check all the critical points on the system and piping connections; tightness has to be ensured also at very low pressure.
- Minimum absolute working pressure: 0.5 bar.
- The installation of mechanical high-pressure and low-pressure cut-outs is mandatory. For systems provided with a service shut-off valve on the discharge side of the compressor, only a mechanical pressure cut-out shall be used. Electronic pressure limiters, which could cause delayed sensor response, are not allowed.
- The high- and low-pressure cut-outs must be installed correctly on the discharge and suction lines, which means that no service valve is allowed between the compressor and the pressure protection (refer to EN 378 or ISO 5149).
- A discharge temperature control is mandatory to stop the compressor when the maximum discharge temperature is exceeded – see **section 3.7 "Discharge gas temperature protection"**.
- Additional warning notices shall be affixed to any system equipped with shut-off valves. The warnings must contain instructions to open the shut-off valves completely after each repair or maintenance work. The compressors may only be energized when the safety measures (high- and low-pressure cut-outs and discharge temperature cut-out) have been checked and verified to be operational.

NOTE: All of the above points must be fulfilled. If only one of them is not complied with, the compressors shall not be operated below atmospheric pressure.

3.6 Crankcase heater



WARNING

Ignition source in a potentially flammable atmosphere! Fire hazard! The crankcase heater, as specified by Emerson (see spare parts catalogue), is not an ignition source during normal operation in A2L systems but could become one if not installed properly according to installation instructions. Ensure correct electrical and mechanical installation.



CAUTION

Overheating and burnout! Compressor damage! Never apply power to the crankcase heater in free air, before the crankcase heater is installed on the compressor or when it is not in complete contact with the compressor shell.

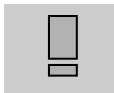

IMPORTANT

Oil dilution! Bearing malfunction! Turn the crankcase heater on 12 hours before starting the compressor.

A crankcase heater is used to prevent refrigerant from migrating into the shell during standstill periods. The installation of a crankcase heater is required when the system charge exceeds the charge limits indicated in **Table 9**. This requirement is independent from system type and configuration.

Compressor model	Refrigerant charge limit (kg)	Crankcase heater	
		Position	Height (mm)
YB12K1E to YB17K1E	1.4		10 - 40
YB21K1E	1.5		
YB24K1E & YB45K1E	1.6		

Table 9: Refrigerant charge limits & crankcase heater position

The initial start-up in the field is a very critical moment for any compressor because all load-bearing surfaces are new and require a short break-in period to carry high loads under adverse conditions. **The crankcase heater must be turned on a minimum of 12 hours prior to starting the compressor.** This will prevent oil dilution and bearing stress on initial start-up. **The crankcase heater must remain energized during compressor off cycles.**

Please refer to the Copeland spare parts & accessories catalogue available at www.climate.emerson.com/en-gb/tools-resources to select the correct crankcase heater model.

Caution: Crankcase heaters must be properly grounded!

For installation, the manufacturer/installer shall follow the recommendations mentioned below.

Assembly instructions

- Choose the appropriate model according to compressor size and required wattage.
- Check the compressor application guidelines for crankcase heater connection and operation.
- Position the crankcase heater between the lower cover and the lower bearing weld projection (**Fig. 6**).
- Fit the heater horizontally around the crankcase, ensuring that it is in close contact with the compressor housing along the entire length.
- Avoid having the heating portion of the heater in contact with any weld projection (**Fig. 7 & 8**).
- Avoid having the assembly heater inclined (**Fig. 9**).
- Close the lock and tighten the screw, torque: 2-3 Nm.
- The excess clamp bracket may be trimmed. Sharp edges must not come into contact with wires.
- The presence of the heater shall be made evident by the posting of caution signs or markings at appropriate locations.



Figure 6



Figure 7



Figure 8



Figure 9

Electrical connection

- Connect the crankcase heater according to the compressor application guidelines.
- The crankcase heater must be connected only to its rated voltage.
- The metal braid of the heater must be connected to a suitable earthing terminal.
- Check the resistance according to the technical data.
- Perform an insulation test before start-up.
- Electrical security and safety measures are to be provided on site.

3.7 Discharge gas temperature protection



CAUTION

Inadequate lubrication! Scroll set damage! All YB*K1E compressors must be equipped with a discharge gas temperature protection.

A good system control shall prevent the system from operating outside the published operating envelope and acceptable superheat range, whatever the climatic conditions and the capacity demand. However, under some extreme operating conditions such as loss of charge or improper control operation, the internal discharge gas temperature reached can cause compressor damage. In order to ensure positive compressor protection, discharge gas temperature protection is required for any application with Copeland brand compressors.

The maximum discharge gas temperature is 130 °C for all YB*K1E compressors.

Discharge gas temperature protection is the "fall-back" for failure of the system control. It is essential that proper control of both the evaporating and condensing pressures and the superheat is maintained and has the ability to cope with all likely conditions and high loads. Reliance on protectors will cause inadequate system performance and short cycling.

NOTE: The maximum discharge gas temperatures indicated in this chapter are valid for safe operation within the approved application envelope. The discharge line thermostat has the function of a compressor protection device; it is not designed to control the operating envelope. For compressor envelope control, an additional control device or regulation must be used.

3.7.1 Excessive discharge gas temperatures

A few of the possible consequences of excessive discharge gas temperatures are listed below:

- Since the oil circulates in the system with the refrigerant, it is subjected to high discharge gas temperatures. If the discharge gas temperature becomes too high, the so-called "cooking" effect will occur (heating of oil under exclusion of air). Carbon deposits can form at points of high temperature, for example on the valves, oil channels, oil filters, etc. The oil lubricity will be reduced and a progressive wear process will occur which will prematurely damage the compressor.
- The stability of the refrigerant can also be affected, particularly if traces of contaminant are present.

The problems described above frequently occur simultaneously, particularly since the chemical reaction speed approximately doubles with every 10 °C temperature rise. This directly leads to chemical reactions of the oil with the refrigerant and the compounds extracted from sealants and insulation material. As a consequence, contaminants of various types, among them acids, will form inside the system.

3.7.2 Discharge line thermostat

YB*K1E compressors have no internal discharge gas temperature protection. Therefore, an external discharge line thermostat must be installed.



Figure 10: Discharge line thermostat with clamp

Technical data of the discharge line thermostat

Compressor		YB*K1E
Voltage		120-240 V AC
Maximum amperage		5 A / 240 V
Operating temperatures	Open	129 °C (± 4 K)
	Close	101 °C (± 8 K)
Wire insulation maximum temperature		150 °C
Clips for tube		∅ 12.7 mm (1/2")

Table 10: Discharge line thermostat – Technical data

To ensure proper functioning and to avoid false readings, the discharge line thermostat must be installed and insulated according to the procedure and recommendations hereunder.

Assembly of the discharge line thermostat

<ul style="list-style-type: none"> Install the discharge line thermostat on the discharge tube 120 mm from top cap. 	
<ul style="list-style-type: none"> Snap the retainer clip over the tube and onto the thermostat. The thermostat should be placed on the discharge tube so that its body is in upward position on a horizontal tube installation. Ensure that the thermostat is not tilted. 	
<ul style="list-style-type: none"> The wire must not be in contact with the top cap of the compressor or the discharge tube. Care should be taken to route wires so that they do not come into contact with sharp objects. 	
<ul style="list-style-type: none"> To avoid any impact on tripping temperature by the ambient, the discharge line thermostat must be insulated. Wrap thermal insulation around the pipe left and right of the thermostat and secure it with plastic straps. 	
<ul style="list-style-type: none"> Wrap a second layer of insulation around the first one and around the thermostat and secure it with plastic straps. 	

3.8 Internal pressure relief valve

There is an internal pressure relief valve on YB*K1E compressors. It opens at a differential pressure of 28 bar \pm 3 bar between high- and low-pressure sides. A high-pressure protection must be provided by the system manufacturer/installer for each system and according to EN 378-2, clause 6.2.6.2. The IPR valve is a safety device, not an HP switch. It is not designed for repeated operation and there is no guarantee that it will reset correctly if it does have repeated operation.

3.9 Discharge check valve

YB*K1E compressors contain an internal check valve on the discharge connection. The discharge check valve prevents the high-pressure discharge gas from flowing rapidly back through the compressor after shutdown.

NOTE: This check valve cannot be used with recycling pumpdown because it is not entirely leak-proof.

3.10 Filter screens



CAUTION

Screen blocking! Compressor breakdown! Use screens with at least 0.6 mm openings.

The use of filter screens finer than 30 x 30 mesh (0.6 mm openings) anywhere in the system should be avoided with these compressors. Field experience has shown that finer mesh screens used to protect thermal expansion valves, capillary tubes or accumulators can become temporarily or permanently plugged with normal system debris and block the flow of either oil or refrigerant to the compressor. Such blockage can result in compressor failure.

3.11 Mufflers

Gas flow through scroll compressors is continuous with relatively low pulsation. External mufflers may not be required on Copeland scroll compressors. Due to system variability, individual tests should be conducted by the system manufacturer to verify acceptable levels of sound and vibration.

If adequate attenuation is not achieved, use a muffler with a larger cross-sectional area to inlet area ratio. A ratio of 20:1 to 30:1 is recommended. A hollow shell muffler will work quite well. Locate the muffler at minimum 15 cm to maximum 45 cm from the compressor for the most effective operation. The farther the muffler is placed from the compressor within these ranges, the more effective. Choose a muffler with a length of 10 to 15 cm.

3.12 Sound shell

For the selection of sound reduction material in A2L applications, attention shall be paid to the electrostatic charge of the material, which could be a potential ignition source.

The standard Emerson sound shell material is not an ignition source for A2L refrigerants (R454C, R455A, R454A and R1234yf).

Please see Copeland spare parts & accessories catalogue at www.climate.emerson.com/en-gb/tools-resources to check the available sound shell kits according to compressor model.

3.13 Insulation material

Insulation material is commonly used in a system to insulate the suction line, suction accumulator, expansion valve bulb or discharge line thermostat. When choosing the insulation material for A2L applications, particular attention shall be paid to its non-electrostatic properties, as it could be a potential ignition source.

3.14 Sound and vibration



WARNING

Vibrations! Creation of a flammable atmosphere! Carefully check the system for vibrations in applications with A2L refrigerants.

Vibrations during compressor operation can cause cracks which could lead to refrigerant leakage. This situation must be avoided by the system manufacturer/installer. To this end, the pipework must be carefully designed when connecting a scroll compressor to a system.

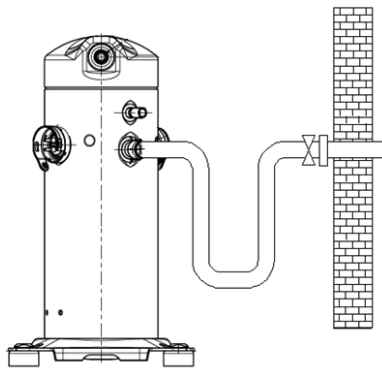

Figure 11: Example of suction tube design

A scroll compressor makes both a rocking and twisting motion and enough flexibility must be provided in the pipework to allow starting, stopping and steady state running of the compressor without transmitting excessive stress into any line attached to the unit. In a split system, the most important goal is to ensure minimal vibration in all directions to avoid transmitting vibrations to the structure to which the lines are fastened.

Under some conditions, the Copeland scroll has a normal starting rotational motion that can transmit a transient noise along the lines. This may be particularly pronounced in compressors using a three-phase motor due to their

inherently higher starting torque. This phenomenon, like the one described previously, can easily be avoided by using standard line isolation techniques.

The sound level of a system is the result of design, quality and application. Scroll compressors sound power levels generally increase with the compressor model capacity and the condition pressure ratio.

3.15 Compressor oil return, oil balancing, refrigerant floodback and oil dilution tests



CAUTION

Inadequate lubrication! Bearing and moving parts destruction! Ensure adequate oil return from the system into the compressor at any time. No liquid refrigerant return to the compressor. Liquid refrigerant dilutes the oil, could wash the oil off the bearings and moving parts and could lead to overheating and compressor failure.

The system piping must be carefully designed to ensure sufficient refrigerant gas velocity, so that oil returns to the compressor at all times and conditions. Individual piping diameter calculation depends on the refrigerant properties, pressure level, mass flow, and density.

Once a new system design is set and assembled, a functional test is required. The functional test includes a qualification for the general system oil return, a refrigerant floodback test and an oil dilution test. Systems with multiple compressors (two, three, or more) require additional oil balancing qualification between the parallel compressors.

A sample compressor equipped with an external oil sight tube can be ordered from Emerson for lab testing.

Records of the evaporating temperature and the bottom shell temperature shall be taken with a high sampling rate during the entire oil return or oil balance testing and under all tested conditions. The liquid level in the sight tube has to be observed and recorded too. Testing conditions shall include defrost and varying loads. If the system is reversible, the tests should be conducted in both operation modes.

System engineers should review the system design and operation to identify the critical conditions and to check oil return, oil balancing, liquid floodback and oil dilution. For discussion of individual test results and system behaviour, eg, with regard to oil dilution, please contact the Application Engineering department. Typically, the following situations should be considered:

- **In single compressor systems:** to check oil return, testing conditions shall be at minimum mass flow and minimum density of suction gas in continuous and frequent start/stop cycling.

- **In multiple compressor systems:** to check oil return and oil balancing in the tandem or trio, testing conditions shall be at the corner points of the system application envelope in continuous and frequent start/stop cycling.
- **In all systems:** to test liquid floodback and oil dilution, all possible transient operation conditions in the system should be checked, eg, compressor frequent start/stop, compressor start after long off time with migration, defrost, switching between the operation modes in reversible systems, load changes, fans or pumps cycling at low load and more. To evaluate the risk of liquid floodback and oil dilution, please refer to the chart in **Figure 12**.

The bottom shell temperature together with the evaporating temperature gives an indication whether liquid refrigerant is returning or diluted in the compressor oil sump. The compressor sump temperature must remain in the (green) safe area, as shown in the chart in **Figure 12** below. In case of operation in the (red) unsafe area, adjustments are required in order to modify the system design, refrigerant charge or superheat setting of the expansion device(s). The bottom shell temperature should be measured accurately. The thermo-probe must be insulated well and positioned on the opposite side of the sight glass or at an angle of 90° clockwise from the suction inlet with view on the top.

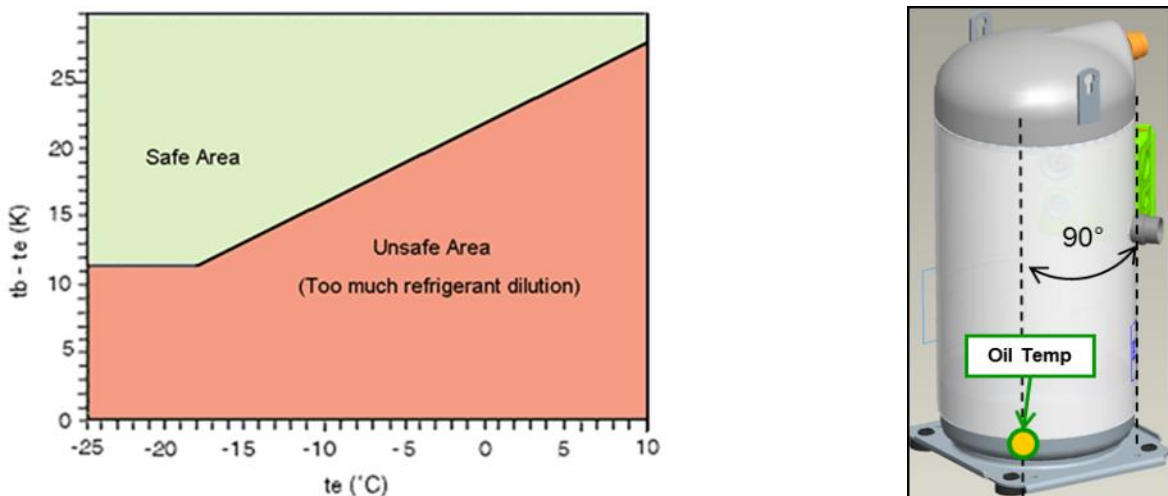

Figure 12: Oil dilution chart (t_b = bottom shell temperature; t_e = evaporating temperature) and position for oil temperature sensor

3.16 Suction line accumulator

Due to Copeland scroll's inherent ability to handle liquid refrigerant, for example in flooded start and defrost cycle operation, an accumulator is not required in most systems.

To determine if a suction line accumulator is required, the system designer must check this with an appropriate test scenario. See **section 3.15 "Compressor oil return, oil balancing, refrigerant floodback and oil dilution tests"**.

If an accumulator is used, the oil-return orifice should be from 1 to 1.4 mm in diameter for all YB*K1E models depending on compressor size and compressor floodback results. To protect this small orifice from plugging with system debris a large-area protective screen no finer than 30 x 30 mesh (0.6 mm openings) is required. Tests have shown that a small screen with a fine mesh can easily become plugged causing oil starvation to the compressor bearings. The size of the accumulator depends upon the operating range of the system and the amount of sub-cooling and subsequent head pressure allowed by the refrigerant control. For the correct selection and size of the suction line accumulator, refer to the manufacturer's specifications.

4 Electrical connection

4.1 General recommendations

The compressor terminal box has a wiring diagram on the inside of its cover. Before connecting the compressor, ensure the supply voltage, the phases and the frequency match the nameplate data.

For safety reasons, Emerson recommends that the electrical installation be executed in compliance with standard EN 60204-1 and/or other standards and regulations of application.

When installing YB*K1E compressors in a system, the following measures must be taken:

- To ensure the wires are properly terminated, the correct terminal and clamping tool for the selected wire size must be used.
- The ground wiring must conform to local regulations and codes of practice (only the provided parts must be used).
- The grounding screw must be torqued to 2.4 to 2.6 Nm.
- A cable strain-relief device must be added.
- Cable and wires must be protected against sharp edges.

4.2 Electrical installation



WARNING

Conductor cables! Electrical shock hazard! Shut off power supply before undertaking any task on electrical equipment.



WARNING

Ignition source in a potentially flammable atmosphere! Fire hazard! In applications with A2L refrigerants, the electrical connection of the scroll compressors is not an ignition source during normal operation but could become one if not installed properly according to installation instructions. Ensure correct mechanical and electrical installation. System capacitors may remain charged for several minutes after shutdown. Before starting to work on the electrical installation make sure sparking is not possible. Continuously check if the ambient atmosphere is non-flammable when working on the electrical installation.



WARNING

Run capacitors! Sparking in a potentially explosive atmosphere! Explosion hazard! Single-phase compressors must be electrically connected to a run capacitor. Run capacitors have a potential ignition source and do not comply with ATEX requirements. The installation of A2L refrigerant systems is only allowed in non-explosive atmospheres, for example in an enclosure for ATEX 94/9/CE Zone 2 according to the relevant standard EN 60079.

For recommended wiring diagrams, see **Figures 14 & 15** next pages.

NOTE: A contactor K2 has to be used for the safety chain to comply with EN 60335 and EN 60204-1.

NOTE: A residual current device (RCD) can be used for additional protection in applications using A2L refrigerants such as R454C, R455A, R454A and R1234yf. The purpose of the RCD is to detect current leaks to the ground in case of electrical issues, for example with the terminal connection pins or electrical accessories.



Figure 13: Residual current device (RCD)

Single-phase compressors (PF*) with internal motor protection:

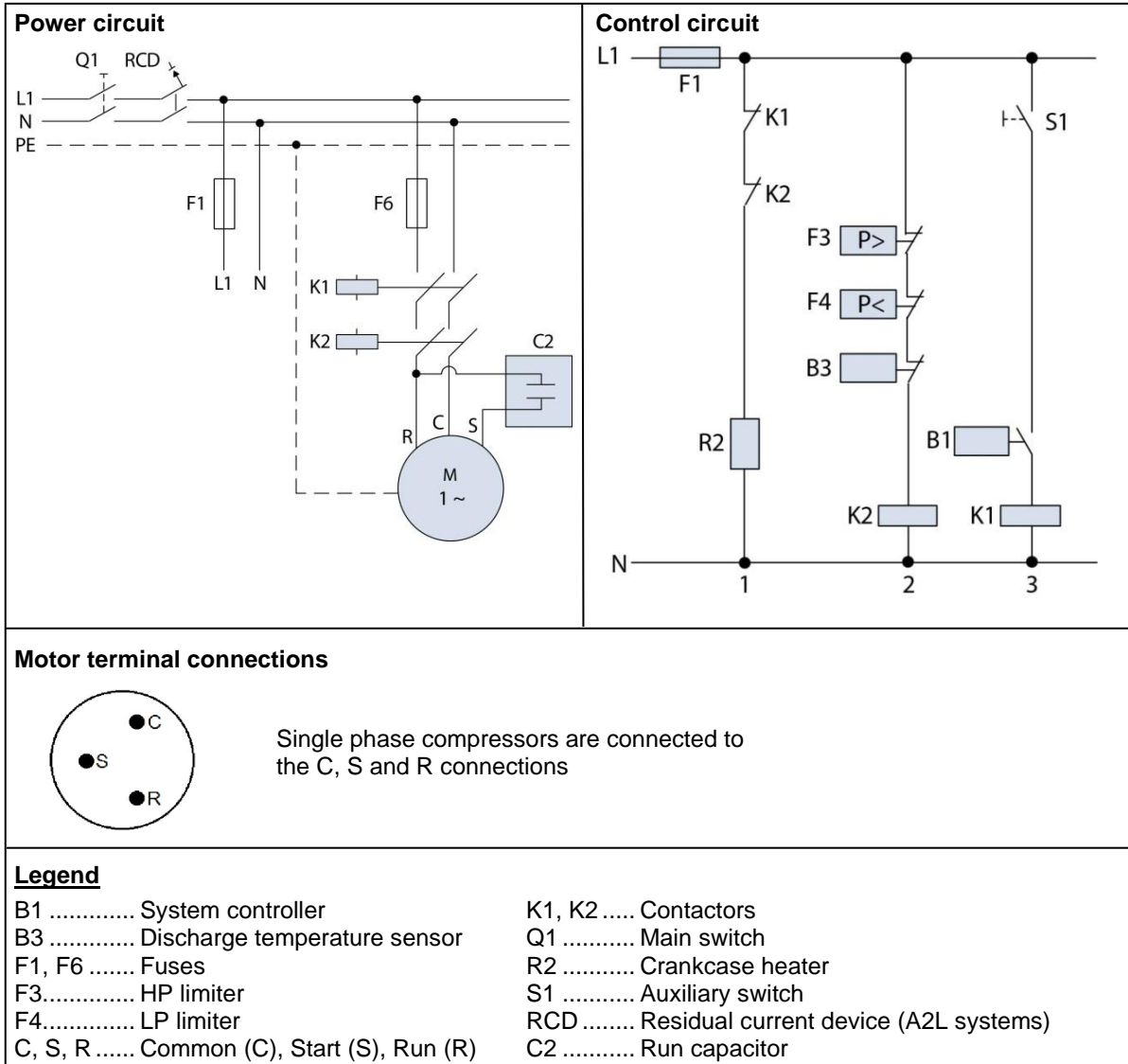

Figure 14: Wiring diagrams for single-phase YB*K1E compressors

Run capacitor for single-phase compressor:

Compressor	Run capacitor
YB12K1E-PFZN	45 μ F / 370 V
YB17K1E-PFZN	50 μ F / 370 V
YB21K1E-PFZN	60 μ F / 370 V
YB24K1E-PFZN	60 μ F / 370 V

Table 11: Run capacitor selection table for single-phase compressors

Please also refer to the Copeland spare parts & accessories catalogue available at www.climate.emerson.com/en-gb/tools-resources.

Three-phase compressors (TF*) with internal motor protection:

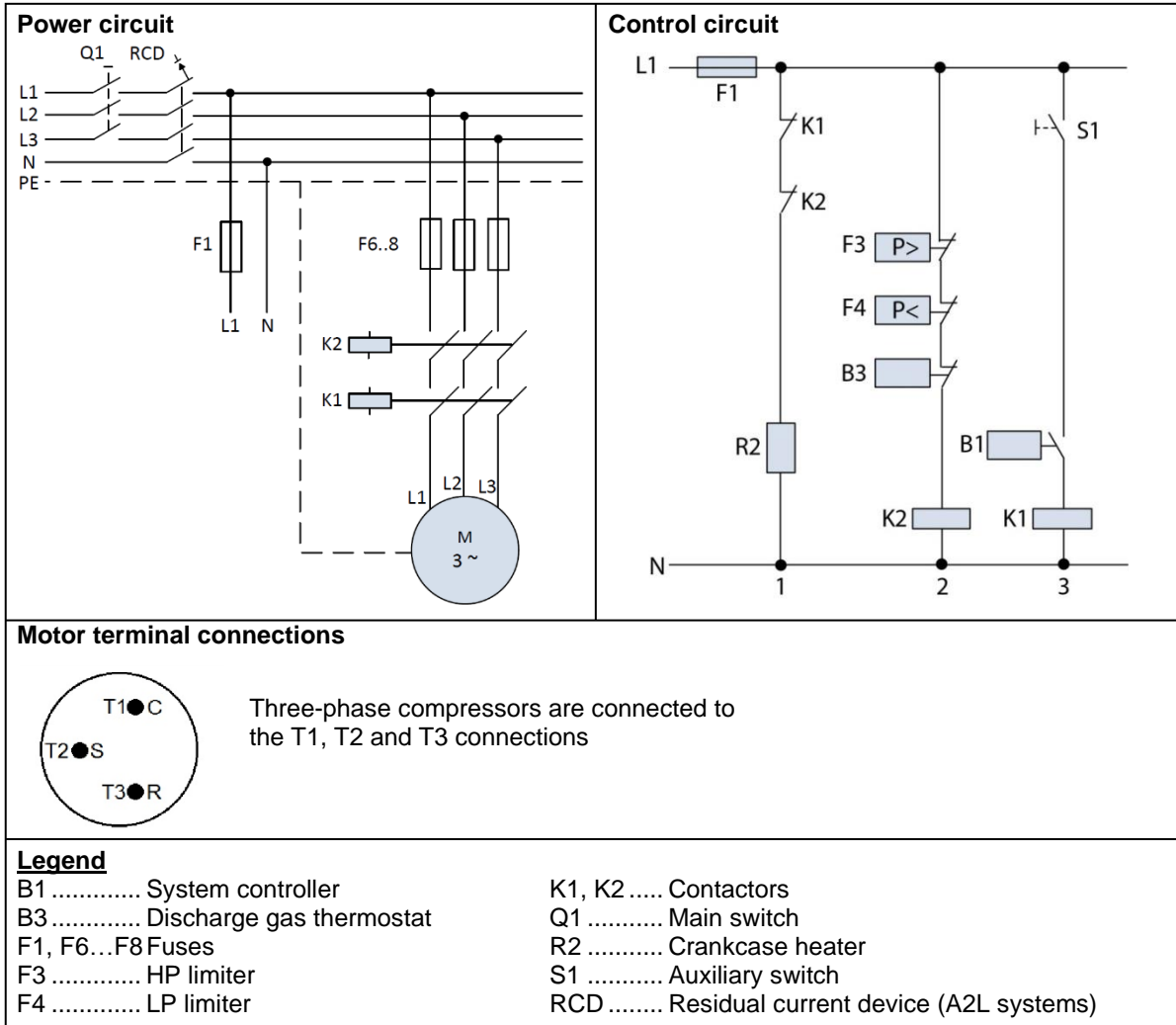

Figure 15: Wiring diagrams for three-phase YB*K1E compressors

4.3 Terminal box



WARNING

Ignition source in a potentially flammable atmosphere! Fire hazard!

Particular attention must be paid in A2L refrigerant systems as any work on the energized terminals in the compressor terminal box could create an ignition. Do not touch the energized terminals with a tool or cable when the compressor is energized.

Compressors operating with flammable refrigerants shall use only the qualified terminal box supplied with the compressor.



CAUTION

Mechanical stress or shock! Overheating! Terminal Fusite damage and leakage! Mechanical stress and shocks to the Fusite must be avoided as they could damage the glass and/or ceramic. This might result in hermetic failure or loss of terminal performance. Precautions are required to prevent striking or bending of pins. Bent or damaged pins may result in loss of hermeticity and/or terminal performance.

Ensure correct connection of cables to the compressor terminal Fusite to avoid local overheating of Fusite pins which might lead to refrigerant leaks.

The terminal box is IP54 for all YB*K1E compressors. This terminal box variation cannot be applied in an ATEX environment.

Cable glands have an influence on the protection class of the terminal box. Emerson strongly recommends using appropriate cable glands according to EN 50262 in order to reach the rated protection class. Examples of correct electrical installations are shown in **Figure 16** below.



Figure 16: IP54 T-Box and correct electrical installation with cable gland

4.4 Motor insulation

The motor insulation material is class "B" (PFZN/TFDN) within maximum allowable operating temperatures according to IEC 34-1 or DIN 57530.

4.5 Motor protection

Independently from the internal motor protection, fuses must be installed before the compressor. The selection of fuses has to be made according to EN 60269-1 or EN 60204-1 and compressor maximum operating current (MOC). Not installing fuses before the compressor or selecting inappropriate fuses may result in compressor failure.

Conventional inherent internal line break motor protection is provided for the complete range of YB*K1E compressors.

4.6 High-potential testing



WARNING

High-potential testing in a flammable atmosphere! Fire hazard! Make sure the atmosphere is non-flammable before performing high-potential testing on a system using A2L refrigerant. DO NOT perform any high-potential test when the compressor is charged with flammable refrigerant.



WARNING

Conductor cables! Electrical shock hazard! Shut off power supply before high-potential testing.



CAUTION

Internal arcing! Motor destruction! Do not perform high-voltage or insulation tests if the compressor housing is under vacuum.

Emerson subjects all scroll compressors to a high-voltage test after final assembly. Each motor phase winding is tested according to EN 60034-1 at a differential voltage of 1000 V plus twice the nominal voltage.

Since high-voltage tests lead to premature ageing of the winding insulation, further additional tests of that nature are not recommended. However, if it has to be done for any reason, it shall not be made with the compressor charged with refrigerant. Run the test with a lower voltage, as described above. Disconnect all electronic devices, eg, motor protection module, fan speed control, etc prior to testing.

Special attention should be paid when performing a high-potential test and reading the Megohm resistance on A2L compressors, as such tests can induce an electrical arc and cause a fire hazard.

For the same reason, compressors removed from a system with A2L refrigerant will need to have the oil drained and a nitrogen purge introduced to flush any remaining refrigerant from the compressor prior to high-potential testing and Megohm resistance reading.

5 Start-up & operation



WARNING

Diesel effect! System explosion! The mixture of air and oil at high temperature can lead to an explosion. Avoid operating with air.



WARNING

Air/flamable refrigerant mixture! Creation of a flammable atmosphere! Make sure the atmosphere is non-flammable before starting the system. Ensure that the system contains only refrigerant.



IMPORTANT

Oil dilution! Bearing malfunction! It is important to ensure that new compressors are not subjected to liquid abuse. It is mandatory to have a crankcase heater installed if the refrigerant charge exceeds a defined value – see **Table 9**. Turn the crankcase heater on 12 hours before starting the compressor.

5.1 Strength-pressure test



WARNING

High pressure! Personal injuries! Consider personal safety requirements and refer to test pressures prior to test.



IMPORTANT

System contamination! Bearing malfunction! Use only dry nitrogen for pressure testing. DO NOT USE other industrial gases.

5.1.1 Compressor strength-pressure test

The compressor has been strength-pressure tested in the Emerson factory. Therefore, it is not necessary for the system manufacturer/installer to strength-pressure test the compressor again.

Scroll compressors are divided into two pressure zones. The compressor high-side and low-side maximum allowable pressures PS have to be respected at all times.

5.1.2 System strength-pressure test

A strength-pressure test of individual sections of the entire system is permitted. Once the compressor is isolated, the rest of the system can be tested with the required pressure values.

The strength-pressure test can also be conducted with the compressor connected, but in that case the two pressure zones of the scroll compressor need to be respected:

- System high-pressure section:
 - Define the system high-side PS \leq compressor high-side PS.
 - Isolate the high- and low-pressure sections of the system by closing valves, solenoid valves, expansion valves or by other means.
 - Use the internal check valve of the compressor on the discharge side or add an external check valve. To protect the compressor internal check valve, observe a maximum pressure delta of ≤ 40 bar between the high-pressure side and the low-pressure side.
 - Activate the check valve with a fast pressure increase. Once the check valve is activated, the pressure increase can be slowed down.
 - At this stage the system test pressure of $1.1 \times$ system high-side PS can be applied for a short time.
 - During the system test, make sure the pressure inside the compressor does not exceed the maximum PS value, which corresponds to the compressor low-pressure PS.
- System low-pressure section:
 - Define the system low-side PS \leq compressor low-side PS.
 - The system test pressure of $1.1 \times$ system low-side PS can be applied for a short time.

5.2 Compressor tightness test



WARNING

High pressure! Personal injuries! Consider personal safety requirements and refer to test pressures prior to test.

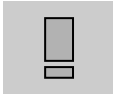

IMPORTANT

System contamination! Bearing malfunction! Use only dry inert gases (for example nitrogen) for leak testing. **DO NOT USE** other industrial gases.

The compressor has been leak-pressure tested in the Emerson factory.

All compressors get a factory holding charge of dry air (about 1 to 2.5 bar, relative pressure). The presence of an intact holding charge serves as a proof of quality against penetrating moisture.

When removing plugs from the compressor, the plugs may pop out due to pressure and oil can spurt.

Any later modification to compressor connections can have an impact on the compressor tightness. Always leak-pressure test the compressor after opening or modifying the connections.

Never add refrigerant to the test gas (as leak indicator).

5.3 System evacuation

Before the installation is put into commission, it has to be evacuated with a vacuum pump. For A2L systems, the vacuum pump and all tools have to be approved for A2L refrigerant/air mixture. The installation should be evacuated down to an absolute pressure of 3 mbar. Proper evacuation reduces residual moisture to 50 ppm. During the initial procedure, suction and discharge shut-off valves on the compressor remain closed. The installation of adequately sized access valves at the furthest point from the compressor on the suction and liquid lines is advisable. The pressure must be measured using a vacuum pressure gauge on the access valves and not on the vacuum pump; this serves to avoid incorrect measurements resulting from the pressure gradient along the connecting lines to the pump.

Evacuating the system only on the suction side of a scroll compressor can occasionally result in a temporary no-start condition for the compressor. The reason for this is that the floating seal could axially seal with the scroll set, with the higher pressure on the floating seal. Consequently, until the pressures equalise, the floating seal and scroll set can be held tightly together.

The highest demands are placed on the leak-proof design of the installation and on the leak testing methods – please refer to EN 378.

When working on systems filled with refrigerant, it may be necessary to repeat the evacuation process several times. Refrigerant may have dissolved in the refrigerant oil and will only gradually condense out.

5.4 Preliminary checks – Pre-starting



WARNING

Air/A2L refrigerant mixture in a potentially flammable or explosive atmosphere! Fire and explosion hazard! Whenever starting up a system charged with A2L refrigerant, eg, after filling, repair, or maintenance, make sure not to start and operate accidentally in a flammable or explosive atmosphere.

Discuss details of the installation with the installer. If possible, obtain drawings, wiring diagrams, etc. It is ideal to use a check-list but always check the following:

- no explosive atmosphere or flammable gas in the ambient, especially for systems with A2L refrigerants;
- suitable ventilation according to room volume and refrigerant charge, especially for systems with A2L refrigerants;
- visual check of the electrics, wiring, fuses etc;
- visual check of the plant for leaks, loose fittings such as TXV bulbs etc;
- compressor oil level;
- calibration of HP & LP switches and any pressure-actuated valves;
- check setting and operation of all safety features and protection devices;

- all valves in the correct running position;
- pressure and compound gauges fitted;
- correctly charged with refrigerant;
- compressor electrical isolator location & position.

5.5 Charging procedure



WARNING

Air/A2L refrigerant mixture in a potentially flammable or explosive atmosphere! Fire and explosion hazard! Only use filling equipment designed and approved for use and operation with A2L refrigerants. Make sure all connections are tight to avoid leakage. Make sure to fill with pure A2L refrigerant.



CAUTION

Low suction pressure operation! Compressor damage! Do not operate with a restricted suction. Do not operate with the low-pressure limiter bridged. Do not operate compressor at pressures that are not allowed by the operating envelope. Allowing the suction pressure to drop below the envelope limit for more than a few seconds may overheat scrolls and cause early drive bearing and moving parts damage.

Prior to charging or re-charging, the refrigerant system must be leak- and pressure-tested with appropriate purging gas.

Ensure that the system is grounded prior to charging with refrigerant.

The system shall be liquid-charged through the liquid receiver shut-off valve or through a valve in the liquid line. The use of a filter-dryer in the charging line is highly recommended. Systems shall be liquid-charged on both the high and low sides simultaneously to ensure a positive refrigerant pressure is present in the compressor before it runs. The majority of the charge shall be placed in the high side of the system to prevent bearing washout during first-time start on the assembly line.

Extreme care shall be taken not to overfill the system with refrigerant.

NOTE: The system manufacturer/installer must respect the charge limitations according to valid standards, such as EN 378.

5.6 Run-in time

Scroll compressors exhibit a slight decrease in input power during the initial running period. Published performance ratings are based on calorimeter testing which is carried out after run-in. Therefore, users should be aware that before the performance specified by EN 12900 is achieved the compressor needs to be run in. Recommended run-in times for YB*K1E compressors to attain the published performance are 16 hours at the standard conditions.

5.7 Initial start-up



CAUTION

High discharge pressure operation! Compressor damage! Do not use compressor to test opening setpoint of high-pressure cut-out. Internal parts are susceptible to damage before they have had several hours of normal running in.

Liquid and high-pressure loads could be detrimental to new bearings. It is therefore important to ensure that new compressors are not subjected to liquid abuse and high-pressure run tests. It is not good practice to use the compressor to test the high-pressure switch function on the production line. The switch function can be tested with nitrogen prior to installation and the wiring can be checked by disconnecting the high-pressure switch during the run test.

5.8 Rotation direction

Scroll compressors, like several other types of compressors, will only compress in one rotational direction. Direction of rotation is not an issue with single-phase compressors since they will always start and run in the proper direction. Three-phase compressors will rotate in either direction

depending upon phasing of the power. Since there is a 50-50 chance of connecting power in such a way as to cause rotation in the reverse direction, **it is important to include notices and instructions in appropriate locations on the equipment to ensure proper rotation direction when the system is installed and operated.**

Observing that suction pressure drops and discharge pressure rises when the compressor is energized allows verification of proper rotation direction. There is no negative impact on durability caused by operating three-phase Copeland scroll compressors in the reverse direction for a short period of time (under one hour) but oil may be lost. Oil loss can be prevented during reverse rotation if the tubing is routed at least 15 cm above the compressor. After several minutes of operation in reverse, the compressor protection system will trip due to high motor temperature. The operator will notice a lack of cooling. However, if allowed to repeatedly restart and run in reverse without correcting the situation, the compressor will be permanently damaged.

All three-phase scroll compressors are identically wired internally. Therefore, once the correct phasing is determined for a specific system or installation, connecting properly phased power leads to the identified compressor terminals will ensure proper rotation direction.

5.9 Starting sound

During the very brief start-up, a clicking sound resulting from the initial contacting of the spirals is audible; this sound is normal. Due to the design of the Copeland scroll compressors, the internal compression components always start unloaded even if system pressures are not balanced. In addition, since internal compressor pressures are always balanced at start-up, low voltage starting characteristics are excellent for Copeland scroll compressors.

5.10 Deep vacuum operation



CAUTION

Vacuum operation! Compressor damage! Copeland scroll compressors in refrigeration or air-conditioning applications with A1-refrigerant should never be used to evacuate a system. Operating scroll compressors in deep vacuum could damage internal motor parts and lead to unacceptable high temperatures in the compressor housing.

For flammable refrigerant operation below atmospheric pressure, see **section 3.5 "System protection for operation below atmospheric pressure"**.

5.11 Shell temperature

During normal operation, the discharge gas as well as the compressor top shell and discharge line can reach temperatures up to the maximum discharge gas temperature of 130 °C – see **section 3.7 "Discharge gas temperature protection"**.

In a failure mode, the discharge gas temperatures can even get higher. Care must be taken to ensure that wiring or other materials that could be damaged by these temperatures do not touch the shell.

5.12 Pumpdown cycle



WARNING

Operation below atmospheric pressure! Fire hazard! During operation below atmospheric pressure in A2L-refrigerant applications, a flammable mixture can form inside the system. Ensure system tightness to prevent any ingress of air. For further details see **section 3.5 "System protection for operation below atmospheric pressure"**.



CAUTION

Vacuum operation! Compressor damage! Compressor operation outside the operating envelope is not allowed.

A pumpdown cycle to control refrigerant migration may have to be used for several reasons, for example when the compressor is located outdoors without any housing so that cold air blowing over the compressor makes the crankcase heater ineffective.

If a pumpdown cycle is used, a separate external check valve must be added. The scroll discharge check valve is designed to stop extended reverse rotation and prevent high-pressure gas

from leaking rapidly into the low side after shut-off. The check valve might in some cases leak more than reciprocating compressor discharge reeds, normally used with pumpdown, causing the scroll compressor to recycle more frequently. Repeated short cycling of this nature can result in a low oil situation and consequent damage to the compressor. The hysteresis of the low-pressure control differential has to be reviewed since a relatively large volume of gas will re-expand from the high side of the compressor into the low side after shutdown.

For pressure control setting, never set the low-pressure limiter to shut off outside of the operating envelope. To prevent the compressor from running into problems during such faults as loss of charge or partial blockage, the low-pressure limiter shall not be set lower than the minimum suction pressure allowed by the operating envelope.

5.13 Minimum run time

Emerson recommends a maximum of 10 starts per hour. There is no minimum off time because scroll compressors start unloaded, even if the system has unbalanced pressures. The most critical consideration is the minimum run time required to return oil to the compressor after start-up. To establish the minimum run time, a sample compressor equipped with an external oil sight glass is available from Emerson. The minimum on time becomes the time required for oil lost during compressor start-up to return to the compressor sump and to restore a minimal oil level that will ensure oil pick-up through the crankshaft. Cycling the compressor for a shorter period than this, for instance to maintain very tight temperature control, will result in progressive loss of oil and damage to the compressor.

5.14 Shut-off sound

Scroll compressors incorporate a device that minimizes reverse rotation. The residual momentary reversal of the scrolls at shut-off can cause a clicking sound. It is entirely normal and has no effect on compressor durability.

5.15 Supply frequency and voltage

There is no general release of standard Copeland scroll compressors for use with variable speed AC drives. A number of considerations must be taken into account when applying scroll compressors with variable speed, including system design, inverter selection, and operating envelopes at various conditions. Only frequencies from 50 to 60 Hz are acceptable.

The last letter of the motor code indicates which frequency and voltage must be applied – see **section 2.2 "Nomenclature"**.

50 Hz	60 Hz	Code
220-240 V / 1 ph	-	Z
380-420 V / 3 ph	460 V / 3 ph	D

Table 12: Electrical codes for motors

5.16 Oil level

Some systems may contain higher than normal refrigerant charges. Systems with large coils, low ambient condenser flooding, or systems with multiple heat exchangers are among some of the configurations that may require additional lubricant.

There is no oil sight glass on YB*K1E compressors.

During the system development phase, adequate oil return from the system to the compressor should be evaluated and qualified. For this purpose, a sample compressor for lab testing, equipped with an external oil sight tube, is available from Emerson. See also information in **section 3.15 "Compressor oil return, oil balancing, refrigerant floodback and oil dilution tests"**.

If an oil regulator is used the oil level should be set within the top half of the oil regulator sight glass.

BOM version GCG contains a stub tube connection 7/8" (22.2 mm) for paralleling on the compressor housing at oil level height.

6 Maintenance & repair



WARNING

Conductor cables! Electrical shock hazard! Follow the lockout/tag out procedure and the national regulations before undertaking any maintenance or service work on the system.

Use compressor with grounded system only. Screwed electrical connections must be used in all applications. Refer to original equipment wiring diagrams. Electrical connections must be made by qualified electrical personnel.



WARNING

Explosive flame! Fire hazard! Oil/refrigerant mixtures are highly flammable. Remove all the refrigerant before opening the system. Avoid working with an unshielded flame in a refrigerant-charged system.



WARNING

Ignition source in a potentially flammable or explosive atmosphere! Fire and explosion hazard! When opening an A2L refrigerant system, the atmosphere could be flammable or explosive. All electrical components that are a source of ignition must always be switched off during service and maintenance. Ensure that the surface temperatures of the components never exceed the limits set by the applicable safety standard, eg, EN 378-2.

Air/flammable refrigerant mixture! Fire and explosion hazard! Remove all the refrigerant before opening the system. Make sure to remove refrigerant completely from all components such as heat exchangers, refrigerant accumulators, etc. Flush the system and the components with inert gas before undertaking any work and before brazing.



WARNING

Open flame in a potentially flammable or explosive atmosphere! Fire and explosion hazard! The area shall be checked with an appropriate refrigerant detector prior to and during work on an A2L refrigerant system, to ensure the technician is aware of a potentially toxic or flammable atmosphere. Ensure that the leak detection equipment is suitable for all applicable refrigerants.

Personnel performing work on a refrigeration system that involves exposing the pipework shall avoid using any ignition source in a way that could lead to a fire or explosion hazard. All sources of ignition shall be kept sufficiently far from the site of installation, repair, removal or disposal during the entire time when refrigerant could be released into the surrounding space.

Open flames and smoking are strictly forbidden at all times.

During service make sure that:

- the area is well ventilated;
- the materials and equipment used are suitable for use under flammable conditions;
- only non-sparking tools are used;
- antistatic gloves and clothes are used;
- build-up of electrostatic charges is avoided;
- no unshielded or naked flame is used.

If parts of the refrigeration system are charged with flammable refrigerant, make sure that all the valves are tightly closed and that the open pipes after the valves are free of refrigerant and oil.

A risk analysis to evaluate all possible risks shall be carried out by the service technician before any repair work on the system.

6.1 Qualification of workers

Personnel working on the maintenance, repair and decommissioning of the system shall be adequately trained. Any work procedure affecting safety shall only be executed by qualified and trained personnel in compliance with national or other equivalent certification systems.

Examples of such work procedures are breaking into the refrigerating circuit, opening sealed components, opening ventilated enclosures, etc...

6.2 Preparation and work procedure

A work procedure shall be provided in the preparation stage. All maintenance personnel and others working at the site shall be instructed on the nature of the work being carried out.

If any work is to be conducted on the refrigeration systems or any associated parts, appropriate fire extinguishing equipment shall be provided. Dry powder or CO₂ fire extinguishers are considered appropriate. Confirm that appropriate fire extinguishing equipment is available near the work area.

Prior to starting to work on systems containing flammable refrigerants, safety checks are necessary to ensure that the risk of ignition is minimized.

Work shall be undertaken under a controlled procedure so as to minimize the risk of flammable gas or vapour being present while the work is being performed.

Avoid working on systems filled with flammable refrigerant in a confined space.

6.3 Disassembling system components

When disassembling system components please follow the main steps described hereunder:

1. For A1 refrigerant systems (R404A, R407A, R407F, R448A, R449A, R407C, R513A, R134a and R450A), recover refrigerant and evacuate system using a recovery unit and vacuum pump. All the refrigerant shall be recovered to avoid significant release.
2. For A2L refrigerant systems (R454C, R455A, R454A and R1234yf), recover refrigerant and evacuate system using an A2L-dedicated recovery unit and vacuum pump. Ensure that the outlet of the vacuum pump is not close to any potential ignition source and that ventilation is available.
3. Flush system with inert gas (dry nitrogen). Compressed air or oxygen shall not be used for purging refrigerant systems.
4. Disassemble components with a cutting tool.
5. Drain, recover and dispose of compressor oil as appropriate.

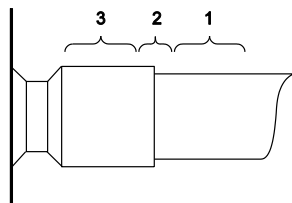

Figure 17: Tube connecting areas

To disconnect:

- Using a pipe cutting tool, cut off the suction and discharge lines in such a manner that the new compressor can easily be re-connected into the system.
- Heat joint areas 2 and 3 slowly and uniformly until the braze material softens and the tube end can be pulled out from the fitting.

To reconnect:

- Recommended brazing material: Silfos with minimum 5 % silver or silver braze used on other compressors.
- Due to the different thermal properties of steel and copper, brazing procedures may have to be changed from those commonly used.

NOTE: Since the discharge stub contains a check valve, care must be taken not to overheat it to prevent brazing material from flowing into it.

6.4 Replacing a compressor



CAUTION

Inadequate lubrication! Bearing destruction! For systems with a refrigerant accumulator, exchange the accumulator after replacing a compressor with a burned-out motor. The accumulator oil return orifice or screen may be plugged with debris or may become plugged. This will result in starvation of oil to the new compressor and a second failure.

Remove refrigerant and oil completely from the replaced compressor.

6.4.1 Compressor replacement

In the case of an A2L-refrigerant compressor replacement, the oil has to be drained out of the compressor and the compressor should be flushed with dry nitrogen. DO NOT close the stubs with plugs.

In case of motor burnout, the majority of contaminated oil will be removed with the compressor. The rest of the oil is cleaned through the use of suction and liquid line filter-dryers. A 100 % activated alumina suction line filter-dryer is recommended but must be removed after 72 hours. When a single compressor or tandem is exchanged in the field, it is possible that a major portion of the oil may still be in the system. While this may not affect the reliability of the replacement compressor, the extra oil will add to rotor drag and increase power usage.

6.4.2 Start-up of a new or replacement compressor

Rapid charging only on the suction side of a scroll-equipped system can occasionally result in a temporary no-start condition for the compressor. The reason for this is that, if the flanks of the scrolls happen to be in a sealed position, rapid pressurisation of the low side without opposing high-side pressure can cause the scrolls to seal axially. As a result, until the pressures eventually equalise, the scrolls can be held tightly together preventing rotation. The best way to avoid this situation is to charge on both the high and low sides simultaneously at a rate which does not result in axial loading of the scrolls.

A minimum suction pressure specified in the published operating envelope must be maintained during charging. Allowing the suction pressure to drop below that value may overheat the scrolls and cause early drive bearing and moving parts damage. Never install a system in the field and leave it unattended when it has no charge, a holding charge, or with the service valves closed without securely electrically locking out the system. This will prevent unauthorised personnel from accidentally operating the system and potentially ruining the compressor by operating with no refrigerant. **Do not start the compressor while the system is in a deep vacuum.** Internal arcing may occur when a scroll compressor is started in a vacuum causing burnout of the internal lead connections.

6.4.3 Compressor return procedure

Compressors from systems with A1 refrigerant can be sent back to Emerson for diagnosis with closed connections and the oil filling inside. However, the refrigerant should be removed.

For all systems with A2L refrigerants, if a compressor has to be returned to the manufacturer for analysis, the refrigerant and the oil have to be removed completely. For the shipping process, all compressor connections must remain open and warning stickers for flammable refrigerant must be placed on the shipping box.

- During the entire working procedure continuously check if the ambient atmosphere is flammable. If a flammable atmosphere is detected, ensure proper ventilation of the working space and immediately cut-off the power supply.
- Resume working after the atmosphere is no longer dangerous.
- Recover the refrigerant from the system using a suitable recovery unit. During this action, the compressor crankcase heater could be energized – immediately de-energize in case a flammable atmosphere is detected.
- Recover to 3 mbar absolute pressure or lower. For best results and to recover also the refrigerant dissolved in the oil, run the recovery unit two or three times as necessary.
- Flush the whole system with oxygen-free dry nitrogen.
- Open the system with a cutting tool and purge the entire system with dry nitrogen.
- Disassemble the compressor with a cutting tool. Drain and recover compressor oil properly. Flush the compressor with dry nitrogen again for a few minutes.
- The compressor should be returned free of oil and with connections open – do not close connections with plugs.
- Collect and secure the oil properly. Provide information about the quantity of oil drained from the compressor and its colour. Ideally, send a good picture.
- Dispose of the oil according to local rules and regulations.
- Use a proper cardboard box package when preparing the compressor for shipment. Place



warning icons on each side and on the top of the box. Mention the following message on the box: **"Warning! Flammable A2L refrigerant compressor for analysis"**.

- The compressor must be kept in the upright position – mark the box accordingly.
- If more than one compressor have to be returned, each compressor must be packed individually.

NOTE: Check with the transport company that all the requirements that apply to such shipments are complied with.

6.5 Exchanging the refrigerant



WARNING

Air/A2L mixture in a potentially flammable or explosive atmosphere! Fire and explosion hazard! For applications with A2L refrigerants, air/A2L mixture in the refrigeration system must be avoided in any case. Make sure that the system is filled with pure A2L refrigerant. In the event that the refrigerant needs replacing, the charge should be recovered using A2L-qualified refrigerant recovery unit and recycling bottles.



CAUTION

Low suction pressure operation! Compressor damage! Do not operate with a restricted suction. Do not operate with the low-pressure limiter bridged. Do not operate compressor at pressures that are not allowed by the operating envelope. Allowing the suction pressure to drop below the envelope limit for more than a few seconds may overheat scrolls and cause early drive bearing and moving parts damage.

For qualified refrigerants and oil, see **section 2.4.1 "Qualified refrigerants and oils"**.

It is not necessary to replace the refrigerant unless contamination, for example due to an error such as topping up the system with a non-condensable gas or incorrect refrigerant, is suspected. To verify correct refrigerant composition, a sample can be taken for chemical analysis. A check can be made during shutdown by comparing the refrigerant temperature and pressure using precision measurements at a location in the system where liquid and vapour phases are present and when the temperatures have stabilised.

6.6 Lubrication and oil removal



WARNING

Air/A2L flammable refrigerant mixture! Flammable and explosive atmosphere! Fire and explosion hazard! Use suitable recovery unit and recycling bottles also for oil disposal as A2L refrigerant may still be dissolved in the oil.



CAUTION

Chemical reaction! Compressor destruction! Do not mix up ester oils with mineral oil and/or alkyl benzene when used with chlorine-free (HFC) refrigerants.

The compressor is supplied with an initial oil charge. The standard oil for use with YB*K1E compressors is a polyolester (POE) lubricant Emkarate RL32 3MAF. See nameplate for original oil charge shown in litres. A field recharge is from 0.05 to 0.1 litre less.

One disadvantage of POE is that it is far more hygroscopic than mineral oil – see **Figure 18**. Only brief exposure to ambient air is needed for POE to absorb sufficient moisture to make it unacceptable for use in a refrigeration system. Since POE holds moisture more readily than mineral oil it is more difficult to remove it through the use of vacuum. The compressors supplied by Emerson contain oil with low moisture content, which may rise during the system assembling process. Therefore, it is recommended that a properly sized filter-dryer be installed in all POE systems. This will maintain the moisture level in the oil to less than 50 ppm. If oil is charged into a system, it is recommended to use POE with a moisture content no higher than 50 ppm.

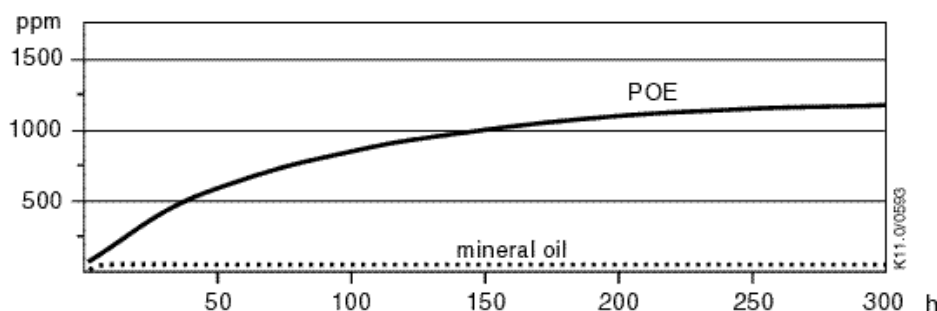

Figure 18: Absorption of moisture in ester oil in comparison to mineral oil in ppm by weight at 25 °C and 50 % relative humidity (h= hours)

If the moisture content of the oil in a refrigeration system reaches unacceptably high levels, corrosion and copper plating may occur. The system should be evacuated down to 3 mbar or lower. If there is uncertainty as to the moisture content in the system, an oil sample should be taken and tested for moisture. Sight glass/moisture indicators currently available can be used with the HFC refrigerants and lubricants; however, the moisture indicator will just show the moisture content of the refrigerant. The actual moisture level of POE would be higher than the sight glass indicates. This is due to the high hygroscopicity of the POE oil. To determine the actual moisture content of the lubricant, samples have to be taken from the system and analysed.

6.7 Oil additives

Although Emerson cannot comment on any specific product, from our own testing and past experience, we do not recommend the use of any additives to reduce compressor bearing losses or for any other purpose. Furthermore, the long-term chemical stability of any additive in the presence of refrigerant, low and high temperatures, and materials commonly found in refrigeration systems is complex and difficult to evaluate without rigorously controlled chemical laboratory testing. The use of additives without adequate testing may result in malfunction or premature failure of components in the system and, in specific cases, in voiding the warranty on the component.

7 Dismantling & disposal



Removing oil and refrigerant:

- Do not disperse in the environment.
- Use the correct equipment and method of removal.
- Dispose of oil and refrigerant according to national legislation and regulations.

Dispose of compressor according to national legislation and regulations.

8 References

Please visit www.climate.emerson.com/en-gb for free download of Application Guidelines and Technical Information.

Performance and technical data:

The latest version of Copeland Select software with performance data and technical data is available from the webpage www.climate.emerson.com/en-gb.

Spare parts and accessories:

Visit www.climate.emerson.com/en-gb/tools-resources for an online version of the Copeland spare parts & accessories catalogue.

Appendix 1: Tightening torques

Connection	Torque (Nm)
M10	45 - 55
Mounting bolts M8 (grommets for single operation)	13 ± 1
Mounting bolts M8 (hard mounting parts for parallel operation)	27 ± 1
Crankcase heater	2 - 3
Terminal block screw	2.8
Ground screw	2.3

DISCLAIMER

1. The contents of this publication are presented for informational purposes only and are not to be construed as warranties or guarantees, express or implied, regarding the products or services described herein or their use or applicability.
2. Emerson Climate Technologies GmbH and/or its affiliates (collectively "Emerson"), as applicable, reserve the right to modify the design or specifications of such products at any time without notice.
3. Emerson does not assume responsibility for the selection, use or maintenance of any product. Responsibility for proper selection, use and maintenance of any Emerson product remains solely with the purchaser or end user.
4. Emerson does not assume responsibility for possible typographic errors contained in this publication.

BENELUX

Josephinastraat 19
NL-6462 EL Kerkrade
Tel: +31 45 535 06 73
Fax: +31 45 535 06 71
benelux.sales@emerson.com

GERMANY, AUSTRIA & SWITZERLAND

Theo-Mack Str. 3
DE-63477 Maintal
Tel: +49 6109 605 90
Fax: +49 6109 60 59 40
ECTGermany.sales@emerson.com

FRANCE, GREECE & MAGHREB

8, Allée du Moulin Berger
FR-69134 Ecully Cédex, Technoparc - CS 90220
Tel: +33 4 78 66 85 70
Fax: +33 4 78 66 85 71
mediterranean.sales@emerson.com

ITALY

Via Ramazzotti, 26
IT-21047 Saronno (VA)
Tel: +39 02 96 17 81
Fax: +39 02 96 17 88 88
italy.sales@emerson.com

SPAIN & PORTUGAL

C/ Pujades, 51-55 Box 53
ES-08005 Barcelona
Tel: +34 93 412 37 52
iberica.sales@emerson.com

CZECH REPUBLIC

Hajkova 22
CZ - 133 00 Prague
Tel: +420 733 161 651
Fax: +420 271 035 655
Pavel.Sudek@emerson.com

ROMANIA & BULGARIA

Parcul Industrial Tetarom 2
Emerson Nr. 4 400641 Cluj-Napoca
Tel: +40 374 13 23 50
Fax: +40 374 13 28 11
ro-bg.sales@emerson.com

ASIA PACIFIC

Suite 2503-8, 25/F, Exchange Tower
33 Wang Chiu Road, Kowloon Bay
Kowloon, Hong Kong
Tel: +852 2866 3108
Fax: +852 2520 6227

UK & IRELAND

Unit 17, Theale Lakes Business Park
Reading, Berkshire RG7 4GB
Tel: +44 1189 83 80 00
Fax: +44 1189 83 80 01
uk.sales@emerson.com

SWEDEN, DENMARK, NORWAY & FINLAND

Pascalstr. 65
DE-52076 Aachen
Tel: +49 2408 929 0
Fax: +49 2408 929 525
nordic.sales@emerson.com

EASTERN EUROPE & TURKEY

Pascalstr. 65
DE-52076 Aachen
Tel: +49 2408 929 0
Fax: +49 2408 929 525
easterneurope.sales@emerson.com

POLAND

ul. Konstruktorska 13
PL-02673 Warsaw
Tel: +48 22 458 92 05
Fax: +48 22 458 92 55
poland.sales@emerson.com

RUSSIA & CIS

Dubininskaya 53, bld. 5, 4th floor
RU-115054, Moscow
Tel: +7 499 403 64 03
ECT.Holod@emerson.com

BALKAN

Selska cesta 93
HR-10 000 Zagreb
Tel: +385 1 560 38 75
Fax: +385 1 560 38 79

MIDDLE EAST & AFRICA

PO Box 26382
Jebel Ali Free Zone - South, Dubai - UAE
Tel: +971 4 811 81 00
Fax: +971 4 886 54 65
mea.sales@emerson.com

For more details, see www.climate.emerson.com/en-gb
Connect with us: facebook.com/EmersonCommercialResidentialSolutions



Emerson Commercial & Residential Solutions
Emerson Climate Technologies GmbH - Pascalstrasse 65 - 52076 Aachen, Germany
Tel. +49 (0) 2408 929 0 - Fax: +49 (0) 2408 929 570 - Internet: www.climate.emerson.com/en-gb

The Emerson logo is a trademark and service mark of Emerson Electric Co. Emerson Climate Technologies Inc. is a subsidiary of Emerson Electric Co.
Copeland is a registered trademark and Copeland Scroll is a trademark of Emerson Climate Technologies Inc.. All other trademarks are property of their respective owners.
Emerson Climate Technologies GmbH shall not be liable for errors in the stated capacities, dimensions, etc., as well as typographic errors. Products, specifications, designs and technical data contained in this document are subject to modification by us without prior notice. Illustrations are not binding.

© 2019 Emerson Climate Technologies, Inc.

EMERSON. CONSIDER IT SOLVED.™