

# UltraCello

Electronic control for Cold Rooms

# CAREL



**ENG** User manual

**LEGGI E CONSERVA  
QUESTE ISTRUZIONI**

**READ AND SAVE  
THESE INSTRUCTIONS**

**NO POWER  
& SIGNAL  
CABLES  
TOGETHER**

**READ CAREFULLY IN THE TEXT!**

High Efficiency Solutions



**WARNING**



CAREL developed its products thanks to the several years of experience in the HVAC field, continuous investment in technological innovation of the product, rigorous quality procedures and processes with in-circuit and function tests on 100% of its production, as well as the most innovative production technologies available on the market. CAREL and its branch offices/affiliates do not guarantee, in any case, that all the aspects of the product and the software included in the product will respond to the demands of the final application, even if the product is built according to state-of-the-art techniques.

The client (builder, developer or installer of the final equipment) assumes every responsibility and risk relating to the configuration of the product in order to reach the expected results in relation to the specific final installation and/or equipment. CAREL, in this case, through specific agreements, can intervene as consultant for the positive result of the final start-up machine/application, but in no case can it be held responsible for the positive working of the final equipment/apparatus.

The CAREL product is a state-of-the-art product, whose operation is specified in the technical documentation supplied with the product or can be downloaded, even prior to purchase, from the website [www.carel.com](http://www.carel.com).

Each CAREL product, in relation to its advanced technological level, needs a phase of definition / configuration / programming / commissioning so that it can function at its best for the specific application. The lack of such phase of study, as indicated in the manual, can cause the final product to malfunction of which CAREL cannot be held responsible.

Only qualified personnel can install or carry out technical assistance interventions on the product.

The final client must use the product only in the manner described in the documentation related to the product itself.

Without excluding proper compliance with further warnings present in the manual, it is stressed that in any case it is necessary, for each CAREL product:

- Not allow the electronic circuits getting wet. Rain, humidity and all types of liquids or condensate contain corrosive mineral substances that can damage the electrical circuits. In any case, the product should be used and stored in environments that respect the temperature and humidity limits specified in the manual;
- Not to install the device in a particularly hot environments. Temperatures that are too high can shorten the duration of the electronic devices, damaging them and distorting or melting the parts in plastic. In any case, the product should be used and stored in environments that respect the temperature and humidity limits specified in the manual;
- Not to try to open the device in any way different than that indicated in the manual;
- Not to drop, hit or shake the device, because the internal circuits and mechanisms could suffer irreparable damage.
- Not to use corrosive chemical products, aggressive solvents or detergents to clean the device;
- Not to use the product in application environments different than those specified in the technical manual.

All the above reported suggestions are also valid for the control, serial boards, programming keys or however for any other accessory in the CAREL product portfolio.

CAREL adopts a continuous development policy. Therefore, CAREL reserves the right to carry out modifications and improvements on any product described in this document without prior notice.

The technical data in the manual can undergo modifications without forewarning.

The liability of CAREL in relation to its products is specified in the CAREL general contract conditions, available on the website [www.carel.com](http://www.carel.com) and/or by specific agreements with customers; specifically, to the extent where allowed by applicable legislation, in no case will CAREL, its employees or subsidiaries be liable for any lost earnings or sales, losses of data and information, costs of replacement goods or services, damage to things or people, downtime or any direct, indirect, incidental, actual, punitive, exemplary, special or consequential damage of any kind whatsoever, whether contractual, extra-contractual or due to negligence, or any other liabilities deriving from the installation, use or impossibility to use the product, even if CAREL or its subsidiaries are warned of the possibility of such damage.

**DISPOSAL**



**INFORMATION FOR THE USERS REGARDING THE CORRECT HANDLING OF WASTE ELECTRIC AND ELECTRONIC EQUIPMENT (WEEE)**

With reference to European Parliament and Council Directive 2002/96/EC issued on 27 January 2003 and the related national implementation legislation, please note that:

- WEEE cannot be disposed of as municipal waste, said waste must be collected separately;
- the public or private waste collection systems defined by local legislation must be used. Moreover, the equipment can be returned to the distributor at the end of its working life when buying new equipment;
- this equipment may contain dangerous substances: improper use or incorrect disposal of such may have negative effects on human health and on the environment;
- the symbol (crossed-out wheeled bin) shown on the product or on the packaging and on the instruction sheet indicates that the equipment has been introduced onto the market after 13 August 2005 and that it must be disposed of separately;
- in the event of illegal disposal of electrical and electronic waste, the penalties are specified by local waste disposal legislation.

Materials warranty: 2 years (from the date of production, excluding consumables).

Type-approval: the quality and safety of CAREL S.P.A. products are guaranteed by the design system and ISO 9001 certified production.

**HACCP: CAUTION**



The Food Safety programs based on HACCP procedures and on certain national standards, require that the devices used for food preservation are periodically checked to make sure that the measuring errors are within the allowed limits of the application of use.

Carel recommends compliance with the indications of European standard "Temperature recorders and thermometers for transport, storage and distribution of chilled, frozen, deep-frozen/ quick-frozen food and ice cream – PERIODIC VERIFICATION", EN 13486 -2001 (or subsequent updates) or similar standards and prescriptions applicable in the country of use.

The manual contains further indications regarding technical feature, proper installation and configuration of the product.

**NO POWER  
& SIGNAL  
CABLES  
TOGETHER**

**READ CAREFULLY IN THE TEXT!**

**WARNING:** separate the probe cables and the digital input cables as much as possible from the inductive load and power cables to prevent possible electro-magnetic interference. Never introduce power cables and signal cables (including those of electric control board) into the same cable troughs.



# Content

<b>1. INTRODUCTION</b>	<b>7</b>	<b>6. CONTROL</b>	<b>45</b>
1.1 Part numbers .....	7	6.1 Switching the controller ON and OFF .....	45
1.2 Expansion modules .....	8	6.2 Virtual probe.....	45
<b>2. INSTALLATION</b>	<b>9</b>	6.3 Set point.....	45
2.1 Assembly and sizes (mm) .....	9	6.4 Pump down.....	47
2.2 Structure .....	10	6.5 Autostart in pump down .....	48
2.3 Wiring diagram.....	11	6.6 Continuous cycle.....	48
2.4 Expansion modules assembly.....	12	6.7 Door switch control.....	48
2.5 Ultra EVD module.....	14	6.8 Defrost.....	49
2.6 Ultra Power module.....	15	6.9 Evaporator Fans.....	51
2.7 EVDice .....	16	6.10 Condenser fans.....	53
2.8 Ultra 3ph module EVAPORATOR.....	16	6.11 Duty setting.....	55
2.9 Ultra 3ph module FULL .....	17	6.12 Bowl resistance.....	55
2.10 Installation .....	18	6.13 Defrosting with 2 evaporators .....	55
2.11 Connection in supervising network.....	18	6.14 Second compressor with rotation.....	56
2.12 UltraCella Service terminal .....	19	6.15 Control with dead band.....	57
2.13 Upload/download parameters (USB memory key).....	19	6.16 AUX output activation by time band.....	57
<b>3. USER INTERFACE</b>	<b>20</b>	6.17 Humidity management.....	58
3.1 Display.....	20	6.18 Dehumidification .....	59
3.2 Keyboard .....	21	6.19 Generic functions.....	61
3.3 Programming.....	22	6.20 Output configuration .....	63
3.4 Procedures.....	24	<b>7. PARAMETERS TABLE</b>	<b>65</b>
3.5 Multifunction menu .....	26	<b>8. SIGNALS AND ALARMS</b>	<b>76</b>
3.6 Message language selection .....	30	8.1 Signalling.....	76
<b>4. COMMISSIONING</b>	<b>31</b>	8.2 Alarms.....	76
4.1 First commissioning .....	31	8.3 Reset alarms.....	76
4.2 Parameters to be set for the commissioning.....	31	8.4 HACCP alarms and display .....	76
4.3 Single digit display models cod. WB000S* commissioning.....	31	8.5 EVD EVO alarms.....	77
4.4 Double digit display models cod. WB000D* commissioning .....	32	8.6 EVDice alarms.....	77
4.5 Commissioning with UltraCella Service Terminal .....	32	8.7 3PH module alarms.....	78
4.6 Main function commissioning.....	33	8.8 Alarm parameters .....	79
4.7 Light management.....	37	8.9 HACCP Alarm parameters and monitoring activation .....	80
4.8 Other configuration parameters .....	37	8.10 High condenser temperature alarm .....	80
4.9 Ultra EVD EVO module commissioning .....	39	<b>9. TECHNICAL SPECIFICATIONS</b>	<b>81</b>
4.10 EVDice commissioning.....	40	9.1 UltraCella technical characteristics.....	81
4.11 Ultra 3Ph Evaporator module commissioning.....	42	9.2 EVD Modules technical characteristics.....	82
4.12 Ultra 3Ph Full module commissioning.....	43	9.3 Power Modules technical characteristics.....	82
<b>5. OUTPUTS CONFIGURATION AND PROTECTIONS</b>	<b>44</b>	9.4 3PH EVAPORATOR Modules technical characteristics .....	82
5.1 Analogue output.....	44	9.5 3PH FULL Modules technical characteristics .....	83
5.2 Digital Outputs .....	44	<b>10. ELECTRICAL WIRING 3PH MODULES</b>	<b>84</b>
		10.1 Electrical wiring 3PH EVAPORATOR Module.....	84
		10.2 Electrical wiring 3PH FULL Module.....	91
		<b>11. SOFTWARE RELEASE</b>	<b>99</b>
		11.1 Software release table.....	99



# 1. INTRODUCTION

UltraCella is a family of products consisting of a control system for the basic functions of a cold room to which can be added further modules for accessory functionalities (e.g. electronic valve, power relays, etc.).

The user interface ensures ease in use and it consists, depending on the models, of:

- wide led display on which can be viewed the operating temperature and the active loads;
- a graphic terminal with text strings in multiple languages, which guide the user during commissioning (wizard). It is also equipped with contextual help menus accessible during programming, that provide an accurate description of the alarms.

The graphic terminal is also available as a "service tool", which is useful when the control has the only LED interface.

UltraCella has a port for the insertion of a USB memory key to:

- load the languages for the graphic terminal during the first commissioning;
- parameters upload/download;
- other operations reserved for the service centre (e.g. software update);
- download log of temperature recorded.

When mounting the optional modules are matched to the right of the main control system and connected to it with watertight coupling, to ensure the IP degree of protection of the assembly.

Main characteristics:

- 6 relay outputs: compressor, defrost, fan, light, AUX1, AUX2;
- assembly on guide DIN or wall;
- LED board with bright display with 3 digits, with decimal point and icons that indicate the operating status;
- integration of the keys in the front panel (LED board) to ensure a high degree of protection (IP65) and safety during operation and cleaning;
- availability of 10 sets of parameters (recipes) preloaded by CAREL but modifiable, corresponding to the same number of parameters configurations, to adapt the control to the specific conservation needs required by the cold room;
- navigation on intuitive user interface with contextual backlight keyboard;
- defrost can be driven using the keyboard, digital input and supervisor;
- various types of defrost managements, on one or two evaporators: natural (with stop compressor), resistance, hot gas;
- control of compressors with up to 2 Hp or up to 3 Hp with the accessory power module;
- temperature control with virtual adjustment probe;
- digital inputs that can be configured for alarm activation, enabling or activating defrost, door switch, auxiliary output, on / off, etc;
- control of 1 compressor with double step or of two compressors, even with rotation;
- keyboard safety: operation of the single keys can be disabled to avoid tampering;
- light management by door switch or dedicated key;
- alarm buzzer;
- HACCP function: temperature monitoring and adjustment in case of alarm due to high temperature during operation or after black out;
- RS485 network connection for remote monitoring and supervision systems.

The accessory modules allow:

- the installation of the electronic expansion valve, using the module with CAREL EVD Evolution driver dedicated to the control of superheat;
- compressor control with power relay of up to 3 Hp;
- the use of a single-phase circuit breaker switch in addition to the power relay.

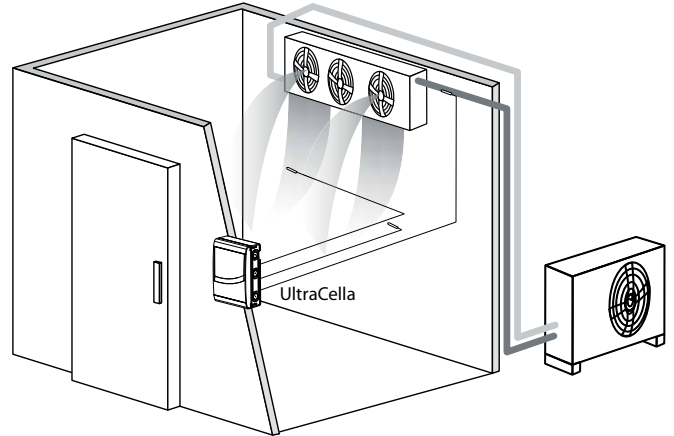


Fig. 1.a

## 1.1 Part numbers

P/N	Description
WB000S**F0	UltraCella, led display with single row
WB000D**F0	UltraCella, led display with double row

Tab. 1.a



Fig. 1.b



Fig. 1.c

## 1.2 Expansion modules

### EVD Module (P/N WM00E\*\*\*00)

Expansion module containing the supply transformer and the driver EVD Evo to control the electronic expansion valve.

P/N	Description
WM00ENS000	Ultra EVD Module without EVD display
WM00ENSI00	Ultra EVD Module with EVD I/E display
WM00ENNI00	"Closed" Ultra EVD module - commissioning with UltraCella
WM00EUN000	"Closed" Ultra EVD module with Ultracap - commissioning with UltraCella
WM00EUS000	Ultra EVD module with Ultracap without EVD display
WM00EUK000	"Closed" Ultra EVD module with Ultracap, stand-alone - commissioning with UltraCella
WM00EUC000	Ultra EVD module without EVD display with Ultracap, stand-alone

Tab. 1.b



Fig. 1.d



Fig. 1.a



Fig. 1.b



Fig. 1.c

### Power module (P/N WM00P000\*N)

Expansion module that contains the circuit breaker switch and 3 Hp relay for compressor control. There is also a version without relay, to give way to the installer to insert devices suitable for the application (contactors, safety devices, etc.)

P/N	Description
WM00P0003N	Ultra Power Module main switch and 3HP relay
WM00P000NN	Ultra Power Module main switch

Tab. 1.c



Fig. 1.d

### Three-phase power modules (P/N WT005\*00N0)

Power 3PH Modules are expansion modules for controlling a single three-phase load, usually the defrost heater. They include a pre-wired three-phase contactor and a four-pole circuit breaker.

P/N	Description
WT005B00N0	Power 3PH module with circuit breaker, defrost 6A
WT005C00N0	Power 3PH module with circuit breaker, defrost 10A
WT005D00N0	Power 3PH module with circuit breaker, defrost 16A

Tab. 1.a

### Three phases expansion Modules

Ultra 3PH Evaporator Modules are expansion modules to control three-phase evaporators. They have to be combined with UltraCella controls P/Ns WB0005% or WB000D% and have inside high power actuators to handle directly three-phase loads of the evaporator.

Ultra 3PH Full Modules are expansion modules to control three-phase condensing and evaporator units. They have to be combined with UltraCella controls P/Ns WB0005% or WB000D% and have inside high power actuators to handle directly three-phase loads of the condensing and evaporator units.

P/N	Description
WT00E600N0	Ultra 3PH Evaporator module 6kW
WT00E900N0	Ultra 3PH Evaporator module 9kW
WT00EA00N0	Ultra 3PH Evaporator module 20 kW
WT00F4B0N0	Ultra 3PH module Full 4HP
WT00F7C0N0	Ultra 3PH module Full 7,5Hp

Tab. 1.d



Fig. 1.e



Fig. 1.f

### UltraCella Service Terminal

The UltraCella control can be connected to an external terminal, without having to open the unit, for easy commissioning and programming of the control parameters, to be used with the controls having LED display. When connecting the UltraCella Service Terminal the LED interface is temporarily disabled.

P/N	Description
PGDEWB0FZ0	UltraCella Service with pGD1 user interface
PGDEWB0FZK	UltraCella Service with pGD1 user interface + 3 m. cable and S90CONN001 connector

Tab. 1.e



Fig. 1.e



## 2. INSTALLATION

### 2.1 Assembly and sizes (mm)

The control system has holes on the lower and right side, in which the installer can insert the cable glands.

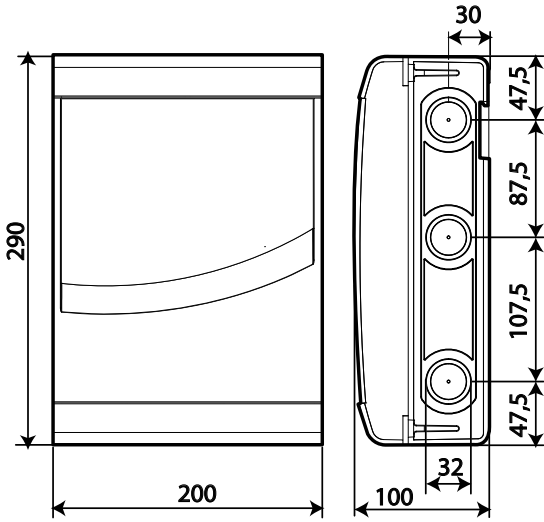


Fig. 2.a

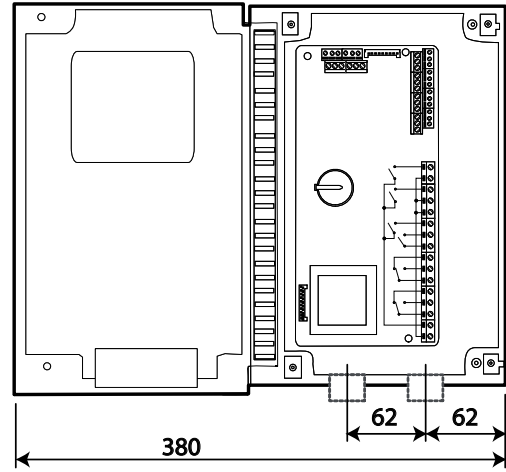
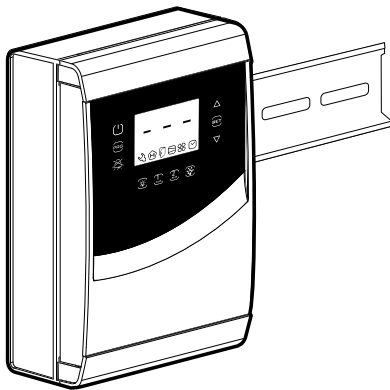


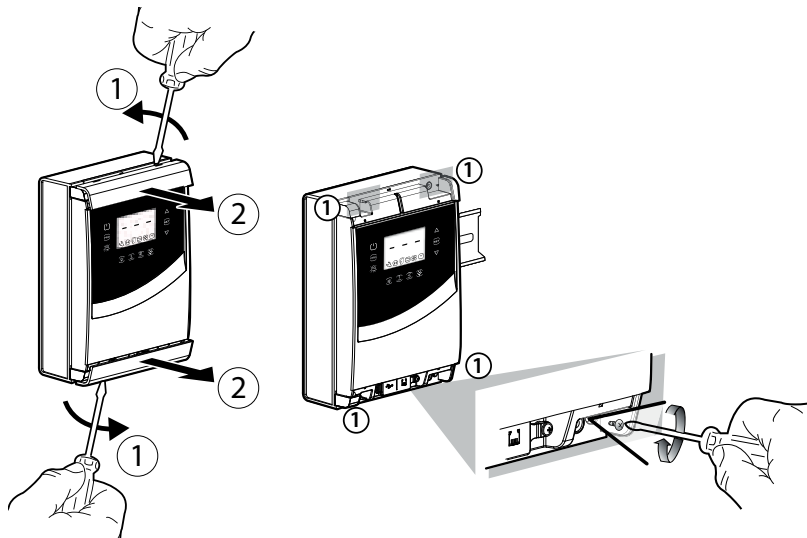
Fig. 2.b

#### Mounting

A: with DIN rail

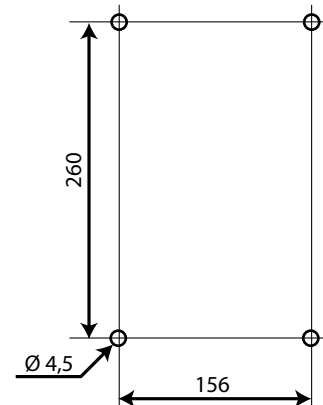


1.a: Fix the DIN rail and insert the controller

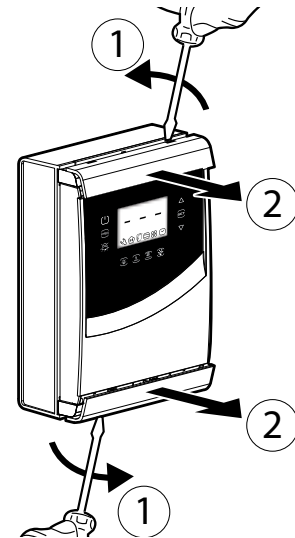


2.a: Remove the frames, loosen the screws (1) and open the panel

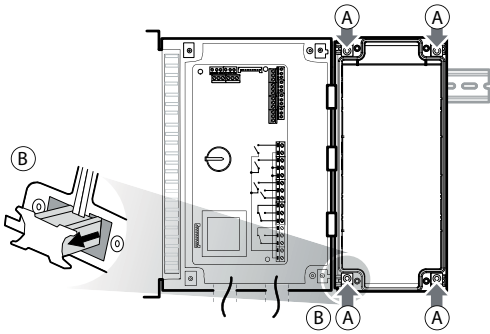
B: without DIN rail



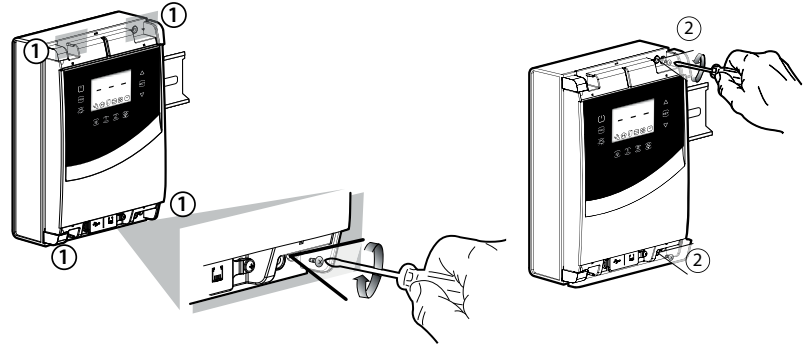
1.b: Make 4 holes (Ø 4,5 mm) according to the drilling template and insert the dowels (mm)



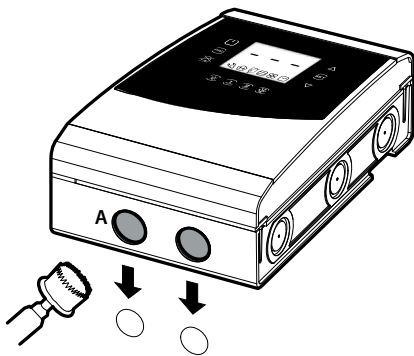
2.b: Remove the frames



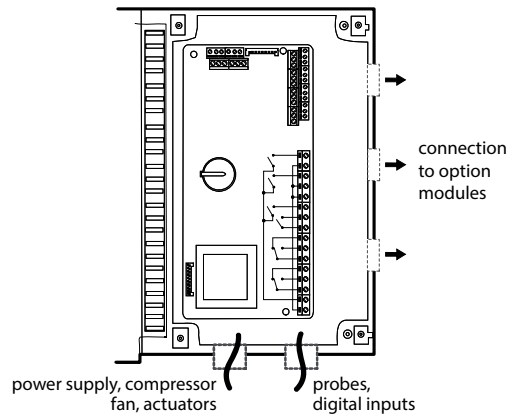
3.a: Mark on the wall the positions of the lower holes, remove the panel and perform the drills (Ø 4.5 mm); insert the plugs. Replace the panel on the DIN guide and fix it fastening the lower screws.



3.b: Fasten the screws (1) and fix the panel. Loosen the screws (2) and open the panel.



- 4: Use the holes and mount the cable glands to connect:
- on the lower side: supply cables, probes, actuators;
  - on the right side: cables for the connection of accessory modules;
- 5: Close the panel fastening the screws (2).



**Caution:** separate the power cables (supply, actuators) from the signal cables (probes, digital inputs).



**Note:** use a hole saw to drill the knock-outs (A).

## 2.2 Structure

Models with single digit display cod. WB000S\*

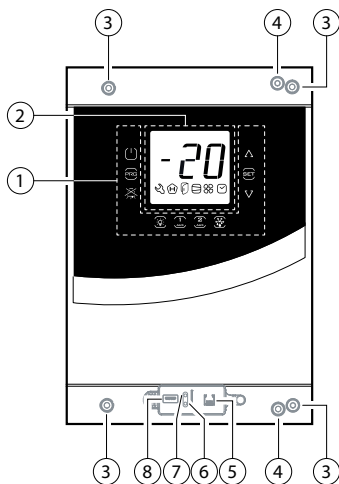


Fig. 2.c

### Key

1	Keyboard
2	Display
3	Wall mounting holes
4	Locking screws
5	Connector for UltraCella Service (*)
6	Green LED (*)
7	Red LED (*)
8	USB Port (*)

(\*) Visible after removing the bottom frame

Models with double digit display cod. WB000D\*

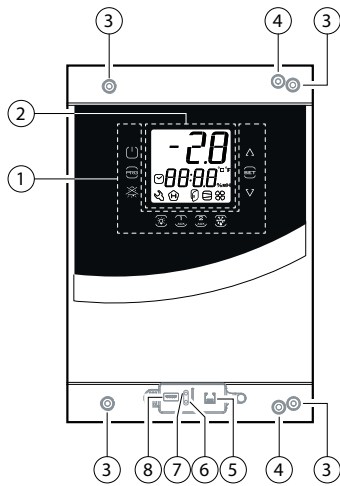


Fig. 2.d

Key

1	Keyboard
2	Display
3	Wall mounting holes
4	Locking screws
5	Connector for UltraCella Service (*)
6	Green LED (*)
7	Red LED (*)
8	USB port (*)

(\*) Visible after removing the bottom frame

2.3 Wiring diagram

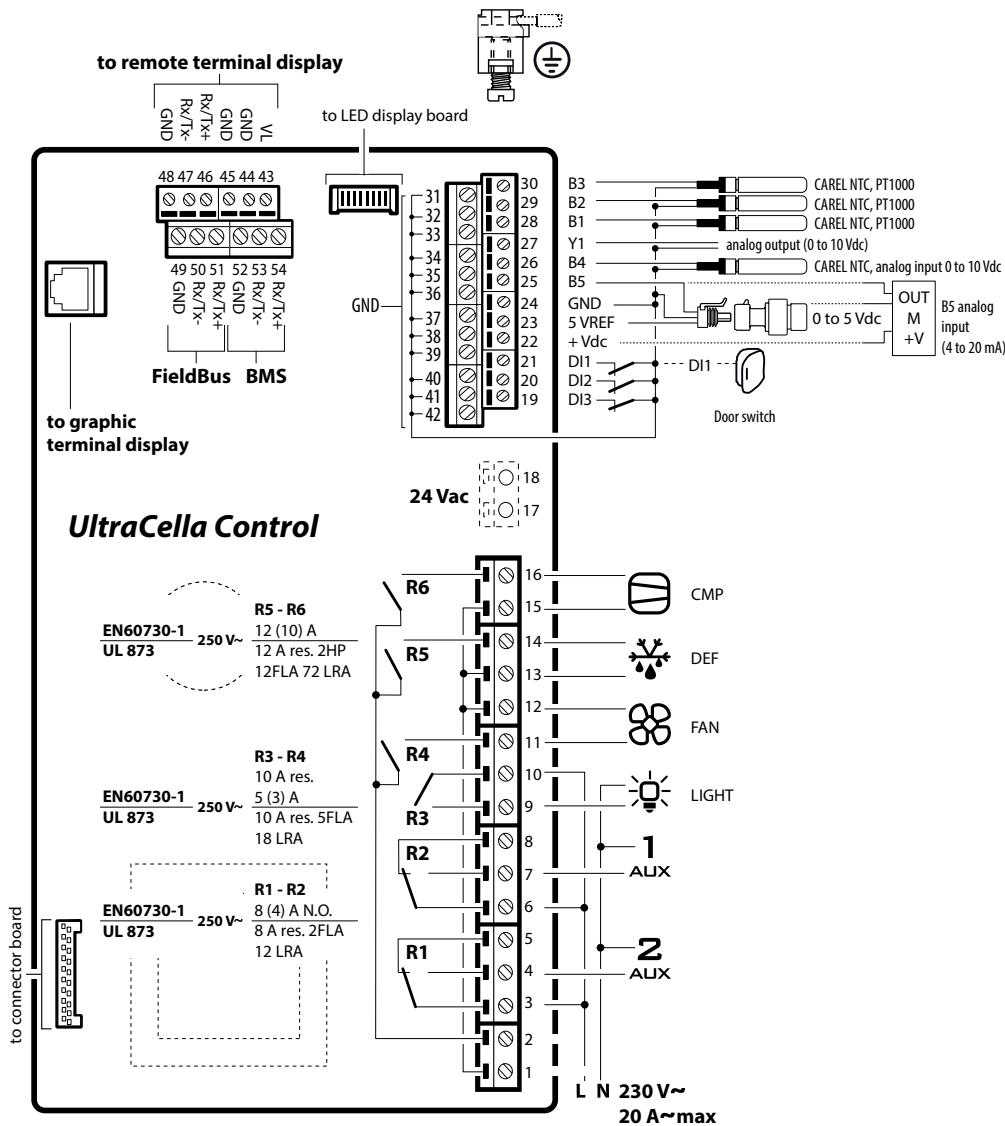


Fig. 2.e

Key

B1...B5	Analogue inputs 1...5
DI1	Door switch
DI2, DI3	Digital inputs 2, 3
Y1	0...10 V analogue output
GND	Grounding for signals
5 VREF	Ratiometric pressure probe power supply
+Vdc	Active probe supply (humidity)
CMP	DO1 (*) Compressor
DEF	DO2 (*) Defrost
FAN	DO3 (*) Evaporator fan
LIGHT	DO4 (*) Light
AUX1	DO5 (*) Auxiliary output 1
AUX2	DO6 (*) Auxiliary output 2
L, N	Power Supply
Fieldbus	Fieldbus Serial (19200 Baud, 8 bit, 2 bit stop, no parity)
BMS	BMS Serial

(\*) Digital outputs display in the multifunction module (see chap. 3).

## 2.4 Expansion modules assembly

Dimensions (mm)

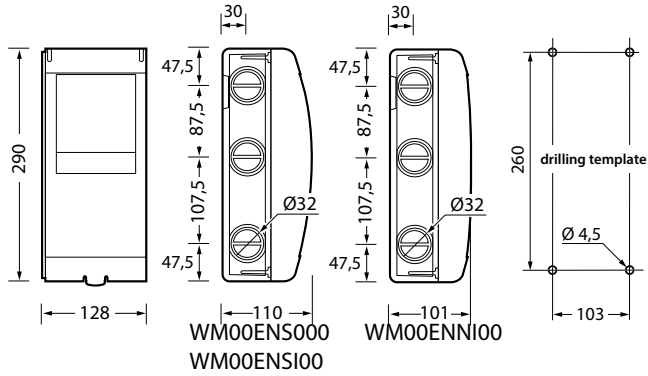


Fig. 2.f

Overall drilling template (mm)

If UltraCella and expansion modules have to be mounted at the same time, use the overall drilling template.

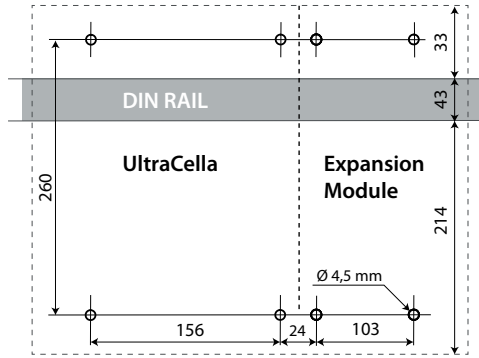


Fig. 2.g

Layout

If more than one expansion modules it is to assemble, use the arrangement of figure to optimize the wiring.

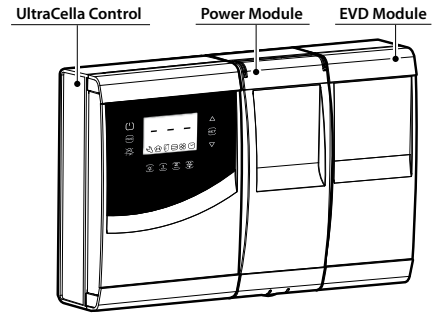
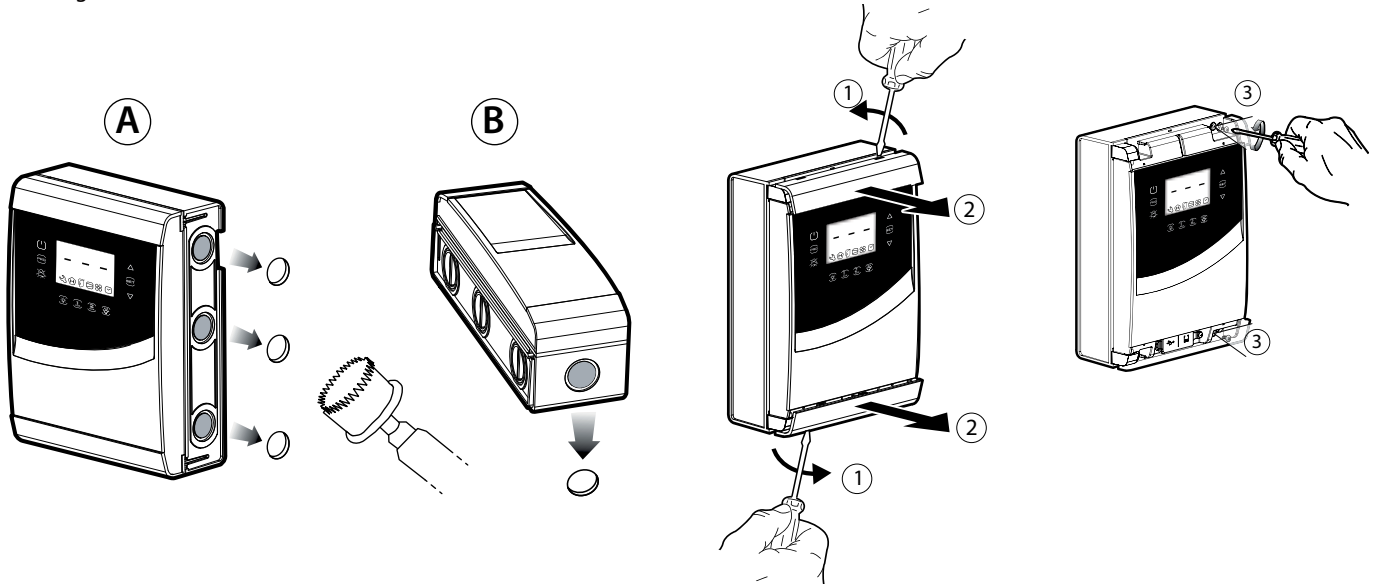


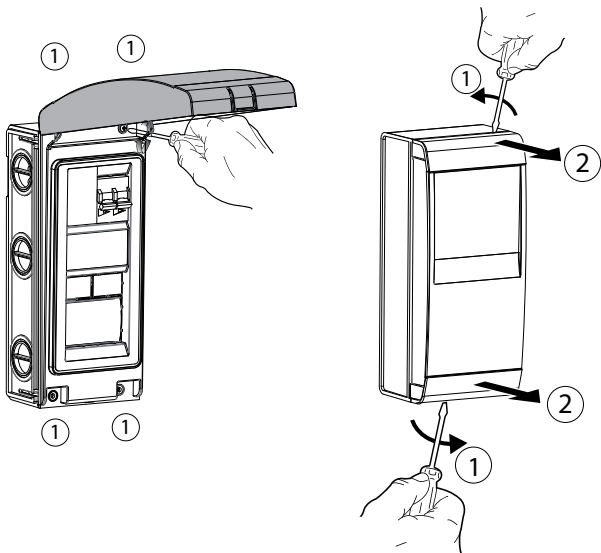
Fig. 2.h

Mounting

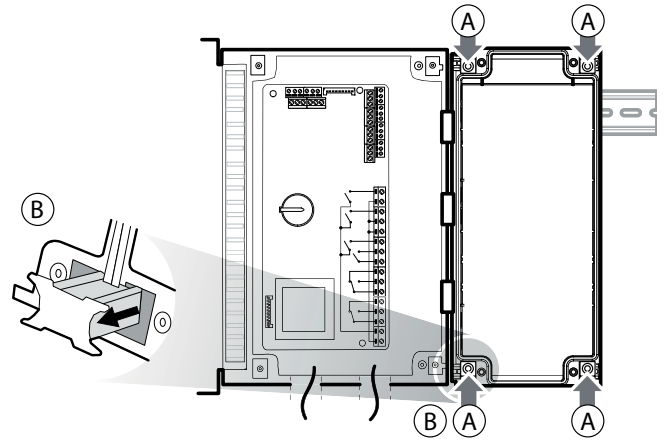


1: Use a hole saw to drill the panel in correspondence with the predrilled holes (steps A, B). If present, fasten the DIN rail for the module.

2: Remove the faceplates. Unscrew the screws (3) and open the UltraCella control



3: Raise the cover or remove the faceplates and unscrew the screws to remove the panel and open the module.



4: Put the module close to UltraCella control and insert the coupling clamps supplied as standard.

## 2.5 Ultra EVD module

### Mounting with DIN rail

5.a Mark the positions of the bottom holes on the wall (A), remove the coupling clamps (B), extract the module (C). Drill the corresponding holes (Ø 4,5 mm) and insert the anchors. Place again the module: mount the coupling clamps (B) and fasten the screws (A).

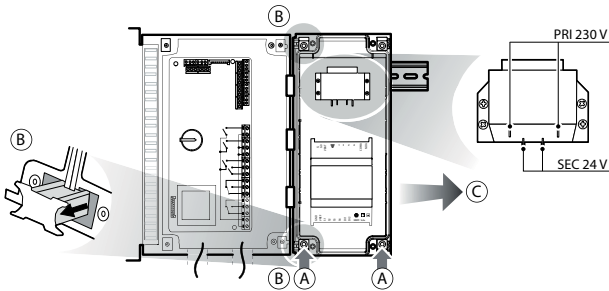


Fig. 2.i

### Mounting without DIN rail

5.b Mark the positions of the 4 holes (A), remove the coupling clamps (B), extract the module (C). Drill the corresponding holes (Ø 4,5 mm), depending on drilling template and insert the anchors. Place again the module: mount the coupling clamps (B) and fasten the screws (A).

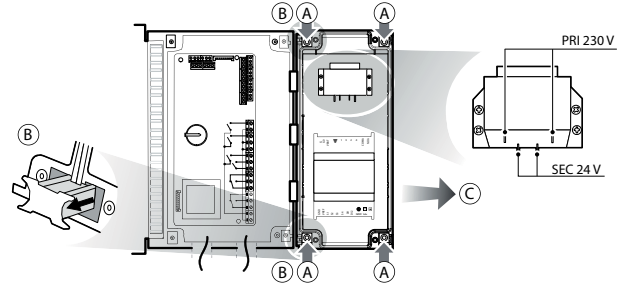


Fig. 2.j

**WM00ENNI00, WM00EUN000 and WM00EUK000:** Connect UltraCella to EVD module by serial cable in according with following wiring diagram e refer to below parameters table about EVD Evo driver commissioning.

**WM00ENSI00, WM00ENS000, WM00EUS000 and WM00EUC000:**

#### 1. Driver commissioning by EVD Evo display.

Connect auxiliary UltraCella output AUX1 or AUX2 relay to digital input DI1 of EVD Evo and set parameters in this way:

- H1=7 (for AUX1) or H5=7 (for AUX2) -> second delayed compressor
- C11=0 -> delay activation second compressor = 0

In this way auxiliary output is set like free contact cooling request, suitable to be connected to digital input DI1 of EVD Evo driver. No setting is requested in UltraCella.

#### 2. EVD Evo driver commissioning by UltraCella

Connect UltraCella to EVD module by serial cable in according with following wiring diagram e refer to below parameters table about EVD Evo driver commissioning. If its' connected by serial cable, driver parameters can be displayed only (not modifiable) by local EVD Evo display.

Once driver is abled by UltraCella (parameter P1=1) its parameters are ones communicated and set by UltraCella, in according with below parameters table (modifiable by UltraCella only); parameters eventually previously set by EVD Evo display will be lost.

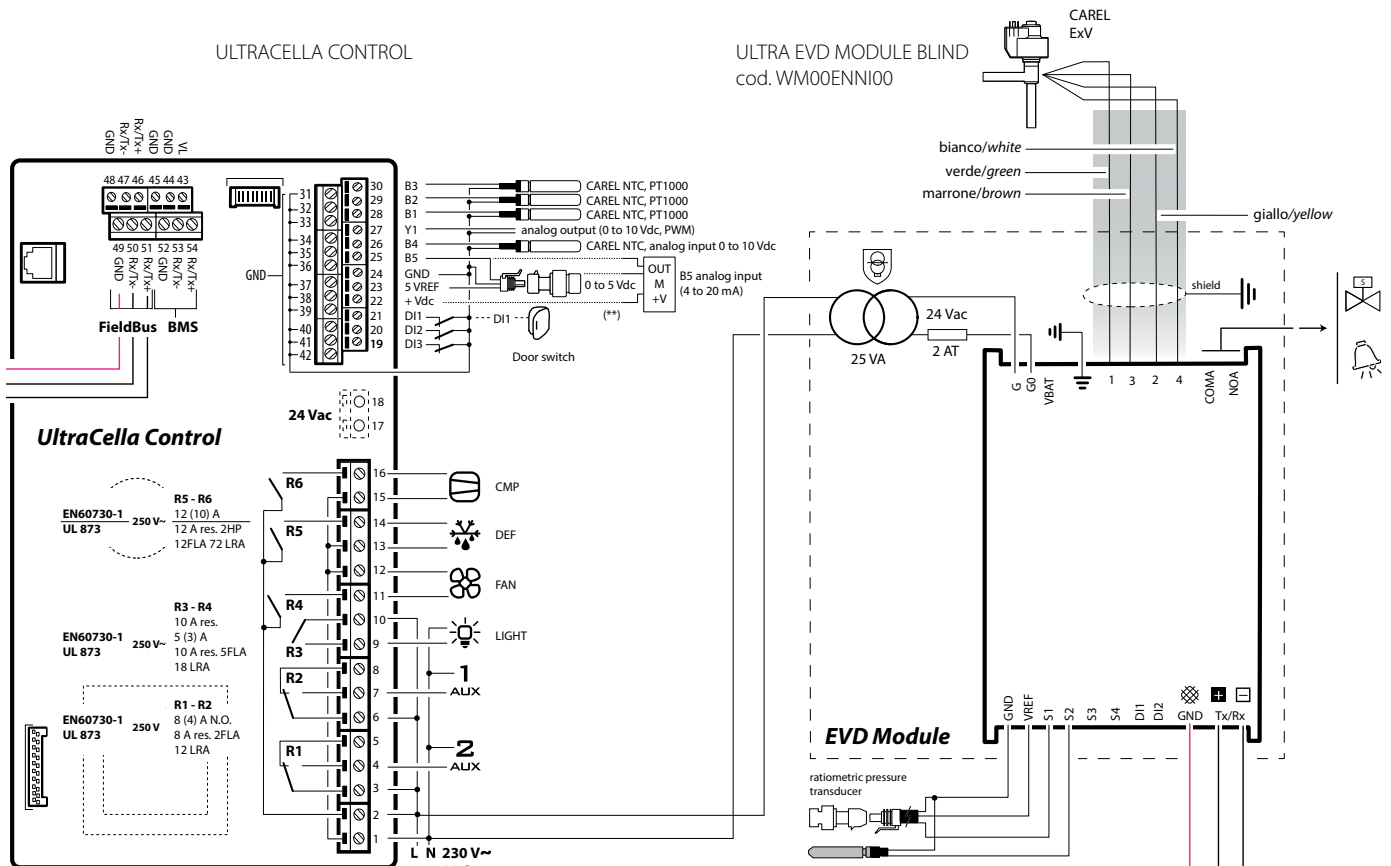


Fig. 2.k

## 2.6 Ultra Power module

### Mounting with DIN rail

5.a Mark the positions of the bottom holes (A), remove the coupling clamps (B), extract the module (C). Drill the corresponding holes (Ø 4,5 mm) and insert the anchors. Place again the module: mount the coupling clamps (B) and fasten the screws (A).

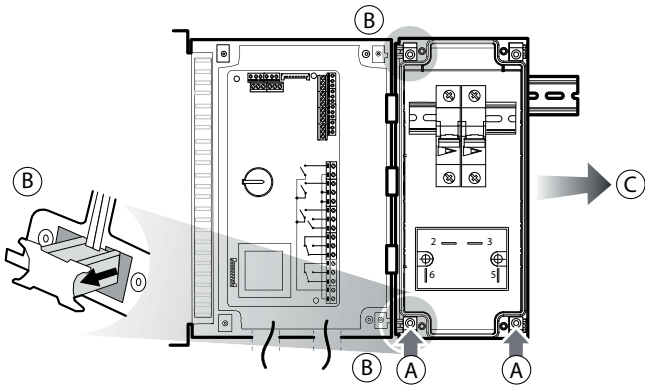


Fig. 2.l

### Mounting without DIN rail

5.b Mark on the wall the positions of the 4 holes (A), remove the coupling clamps (B), extract the module (C). Drill the corresponding holes (Ø 4,5 mm), depending on drilling template and insert the anchors. Place again the module: mount the coupling clamps (B) and fasten the screws (A).

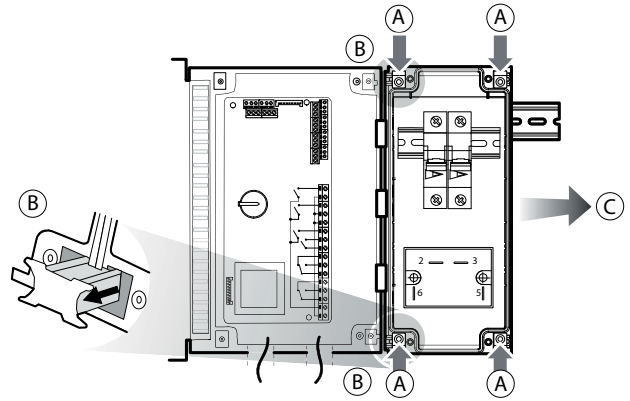


Fig. 2.m

Connect electrically the module wiring according to the diagram.

### ULTRACELLA CONTROL

### ULTRA POWER MODULE

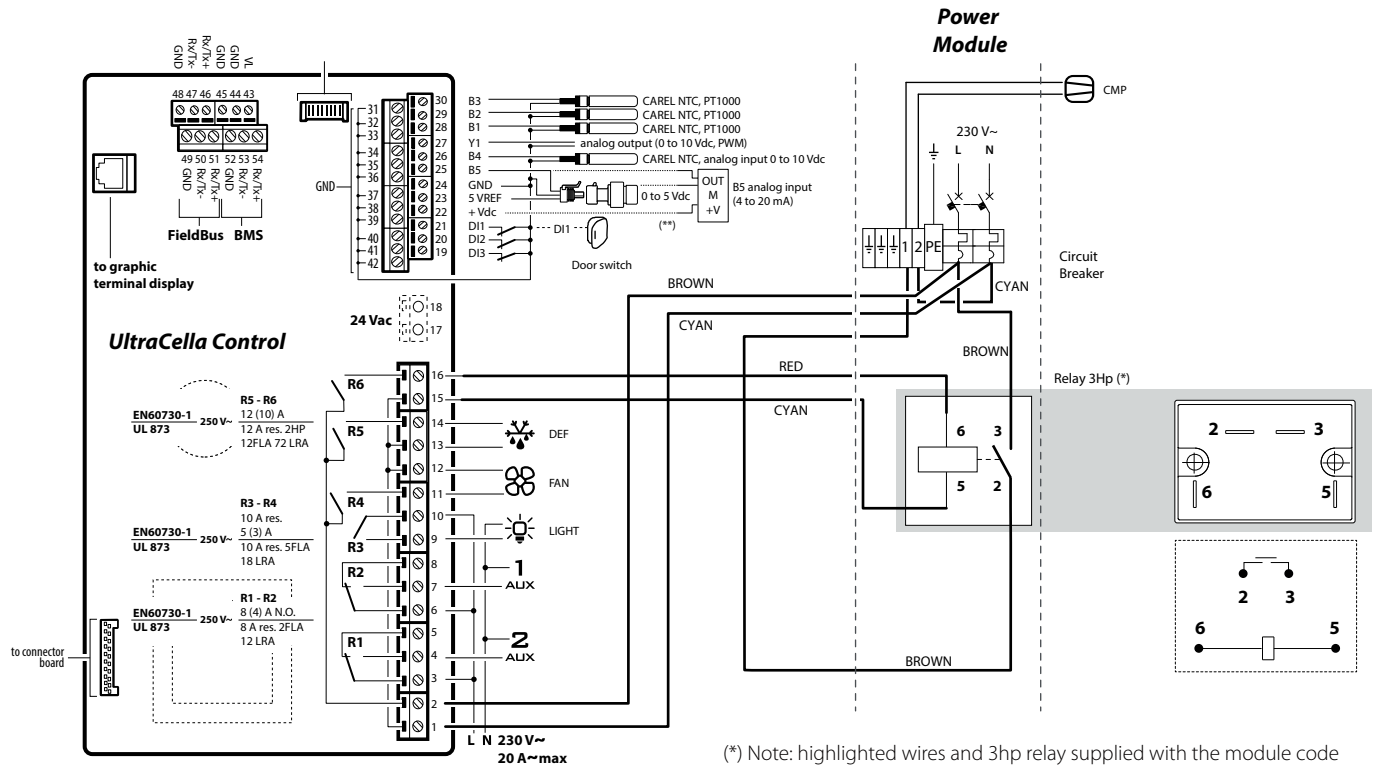


Fig. 2.n

### 2.7 EVDice

For details on assembling EVD ICE on the evaporator, see the user manual, +0300037EN

Connect UltraCella to the EVD ICE driver via the Fieldbus serial line (RS485 Modbus protocol), as shown in the following wiring diagram, and refer to the parameter table for the driver configuration

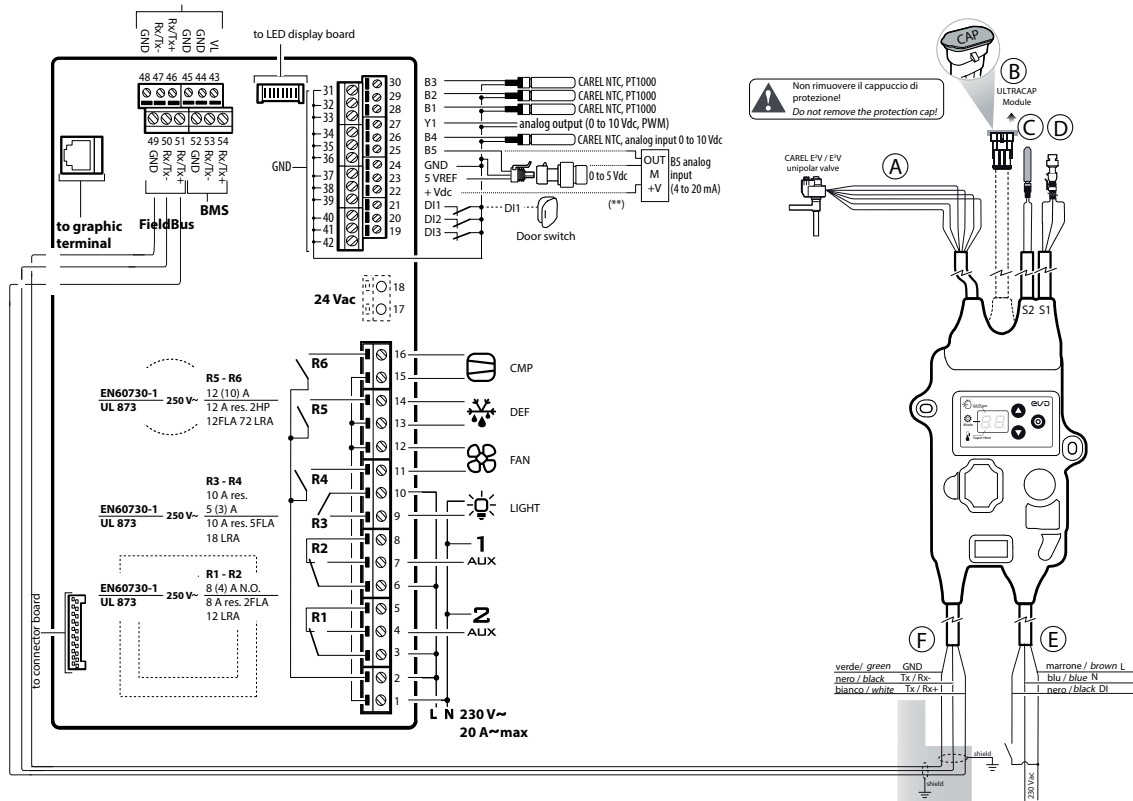


Fig. 2.o

### 2.8 Ultra 3ph module EVAPORATOR

- Following drilling template, drill 4 (6) holes on the wall:
  - Unscrew 6 fixing screws of frontal cover
  - Remove frontal cover
  - Fix panel to the wall by using screws with suitable length to wall thickness
  - Drill side surface of expansion module where it's necessary and fit cable glands to connect: power supply cables, serial cable, probes and power cables for loads

**! Important:**

- separate the power cable (power supply, actuators) from the signal cables (probes, digital inputs) and serial cable
  - use cable with section suitable to current rating they have to carry
  - connect clamp marked with PE to the ground of power supply system
- Connect three-phase expansion to UltraCella by shielded serial cable AWG 22
  - Close frontal by screwing the 6 screws
  - Power on UltraCella (230 Vac) and expansion three-phase module (400 Vac)
  - Activate magnetothermic switch.

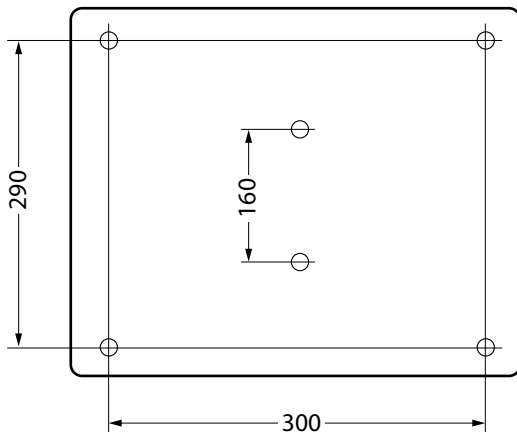


Fig. 2.p



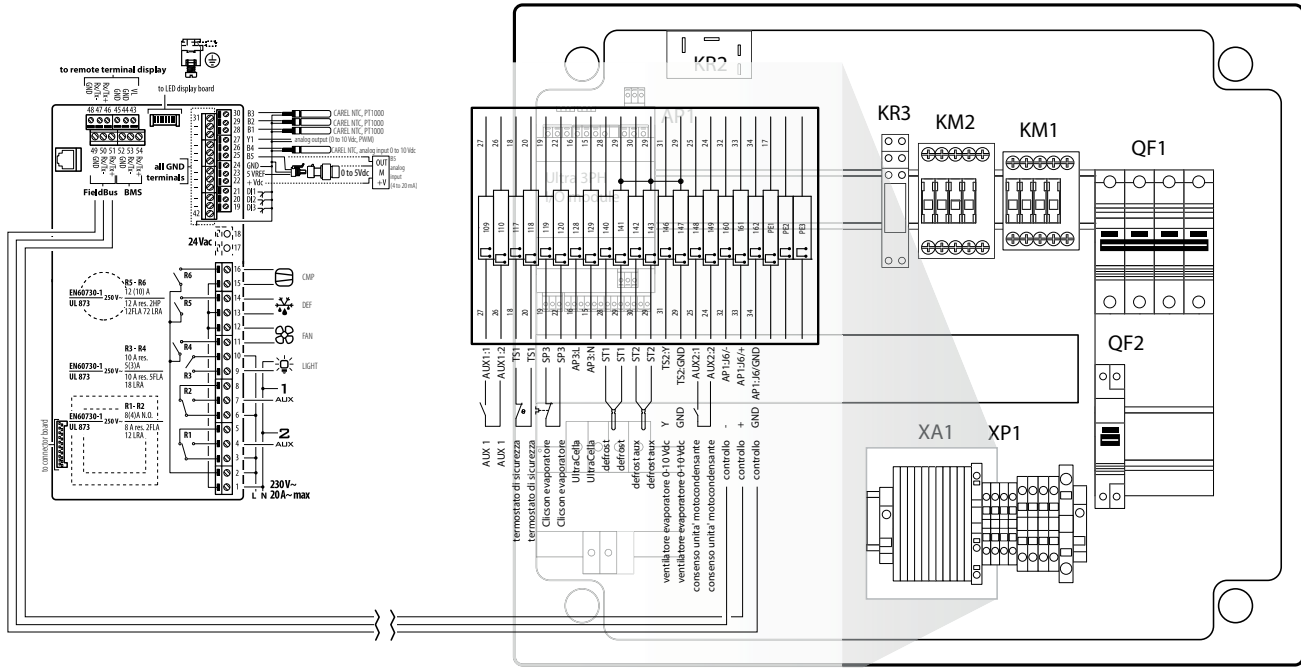


Fig. 2.q

## 2.9 Ultra 3ph module FULL

- Following drilling template, drill 4 (6) holes on the wall:
  - Unscrew 6 fixing screws of frontal cover
  - Remove frontal cover
  - Fix panel to the wall by using screws with suitable length to wall thickness
  - Drill side surface of expansion module where it's necessary and fit cable glands to connect: power supply cables, serial cable, probes and power cables for loads

### ! Important:

- separate the power cable (power supply, actuators) from the signal cables (probes, digital inputs) and serial cable
- use cable with section suitable to current rating they have to carry
- connect clamp marked with PE to the ground of power supply system
- after powering on three-phase expansion check the correct rating current absorption on the loads

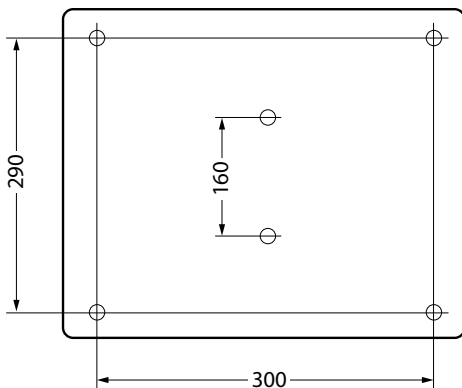


Fig. 2.r

- Connect three-phase expansion to UltraCella by shielded serial cable AWG 22

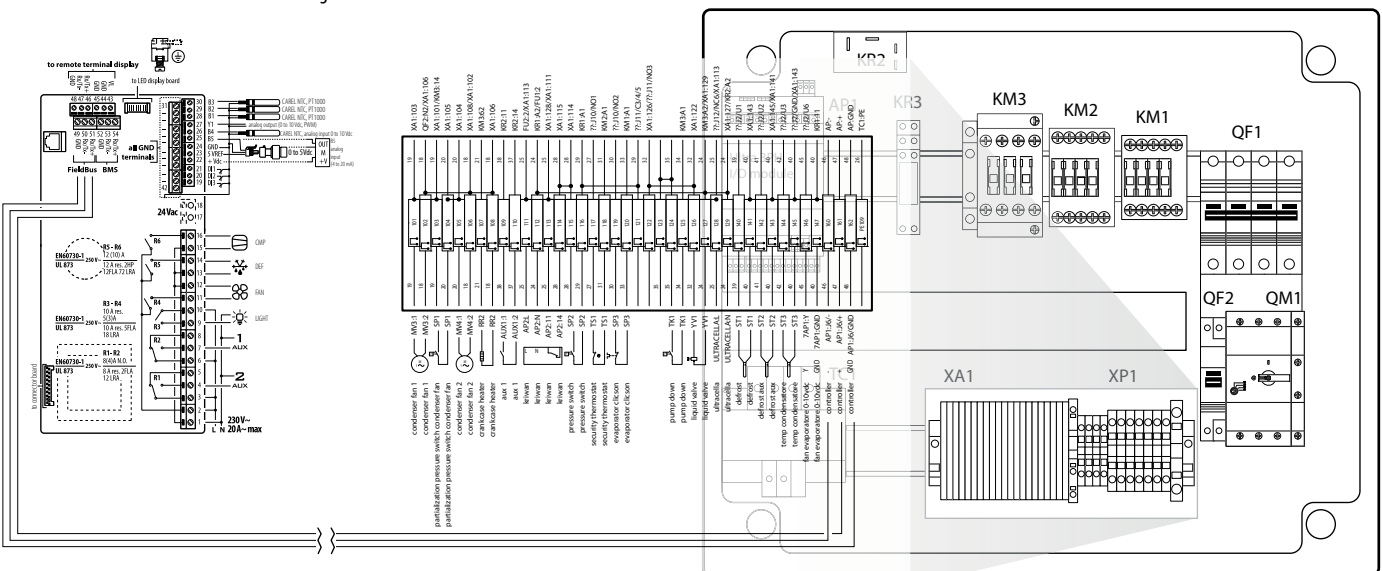
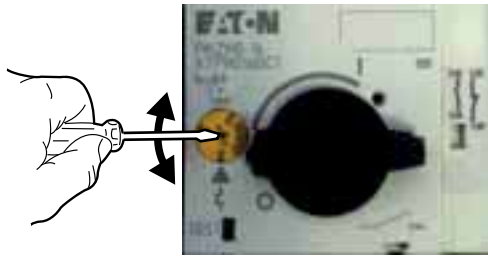


Fig. 2.s

3. Close frontal by screwing the 6 screws
4. At the first start-up of the unit, it's suggested to calibrate motor circuit breaker on effective compressor absorption rating



5. Power on UltraCella (230Vac) and expansion three-phase module (400Vac)
6. Activate magnetothermic switch and motor circuit breaker

### 2.10 Installation

Proceed as follows for installation, making reference to the wiring diagrams in the previous paragraphs:

1. Connect the supply and probes: the probes can be remote-controlled up to a maximum distance of 10 metres from the controller as long as cables with minimum section of 1 mm<sup>2</sup> are used.
2. Program the control: as indicated in chapter "Commissioning" and "User interface";
3. Connect the actuators: the actuators should only be connected after having programmed the controller. It is recommended to carefully evaluate the maximum capacities of the relays indicated in table "Technical specifications".
4. Connection to the serial network (if present): all controls are fitted with a serial connector for connection to the supervisory network.

**Warnings:** avoid installing UltraCella control system in environments with the following characteristics:

- relative humidity over 90% non-condensing;
- strong vibrations or knocks;
- exposure to continuous jets of water;
- exposure to aggressive and polluting atmospheric agents (e.g.: sulphur and ammonia gases, saline mist, smoke) to avoid corrosion and/or oxidation;
- high magnetic and/or radio frequency interference (e.g. near transmitting antennas);
- exposure of the control system to direct sunlight and atmospheric agents in general.

The following recommendations must be respected when connecting the controllers:

**Warnings:**

- incorrect connection of the power supply may seriously damage the control system;
- use cable ends that are suitable for the terminals. Loosen every screw and fit the cable end, next tighten the screws and gently pull the cables to check their tightness. If using an automatic screwdriver, adjust the torque to a value less than 0.5 N · m;
- separate as much as possible (by at least 3 cm) the probe signal and digital input cables from inductive loads and power cables, to avoid any electromagnetic disturbance. Never lay power cables and probe cables in the same cable conduits (including those for the electrical panels). Do not install the probe cables in the immediate vicinity of power devices (contactors, circuit breakers or other). Reduce the length of the sensor cables as much as possible, and avoid spirals around power devices;
- only use IP67 guaranteed probes as end defrost probes; place the probes with the vertical bulb upwards, so as to facilitate drainage of any condensate. Remember that the thermistor temperature probes (NTC) have no polarity, so the order of connection of terminals is not important.

**Caution:** in order to ensure the safety of the unit in the event of serious alarms, all the electromechanical safety devices required to guarantee correct operation must be fitted on the unit.

### HACCP - CAUTION

When the temperature measurement is relevant for Food Safety (see HACCP), will be used only temperature probes suggested by Carel. The standards in force may require the compilation and preservation of appropriate documentation, as well as periodic checks on instrumentation and sensors. If in doubt, consult the person in charge of food safety or the manager of the plant.

### 2.11 Connection in supervising network

Warnings:

- properly fix the converter to avoid disconnections;
- perform the wiring without power supply;
- keep the cables of the converter CVSTDUMORO separate from power cables (supply and relay outputs).

The RS485 converter allows you to connect to the UltraCella control network to the monitoring network for complete control and monitoring of controls connected. The system provides a maximum of 207 units with a maximum length of 1000 m. For the connection it is requested the accessory standard (RS485-USB converter cod. CAREL CVSTDUMORO) and a terminating resistor of 120 Ω to be placed on the terminals connected to the last control. Connect RS485 converter to the controls as shown in the figure. For assigning the serial address see the parameter H0. See the instruction sheet of the converter for further information.

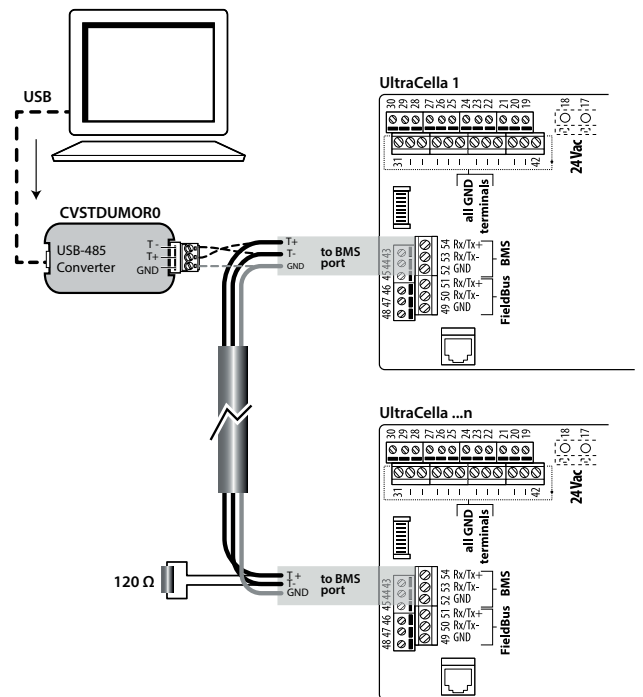


Fig. 2.t

UltraCella can be connected to both PlantVisor and PlantWatch via BMS port (RS485).

Starting from 1.5 release software, both CAREL and Modbus protocols are available from BMS port, selectable by H7 parameter.

- H7 = 0 CAREL protocol
- H7 = 1 Modbus protocol

Starting from software release 1.7, the baud rate, stop bits and parity of the BMS port can be set using parameters H10, H11 and H12; the data bits setting on the other hand remains fixed at 8.

Par.	Description	Def	Min	Max	U.M.
H10	BMS baud rate bit/s	4	0	9	-
	0	1200	5	38400	
	1	2400	6	57600	
	2	4800	7	76800	
	3	9600	8	115200	
H11	BMS stop bits	2	1	2	-
	1	1 bit stop			
H12	BMS parity	0	0	2	-
	1	odd			
	2	even			

➡ Note: To make the change active, switch on and switch off the unit.

### 2.12 UltraCella Service terminal

The UltraCella Service Terminal has to be connected via a dedicated connector, that can be accessed after removing the lower frame. Using the "UltraCella Service Terminal" you can:

- during the first commissioning: insert the first configuration parameters following the guided procedure (wizard);
- during normal operation:
  1. display the active loads and the main variables: temperature, humidity;
  2. perform the control programming, facilitated by contextual help.

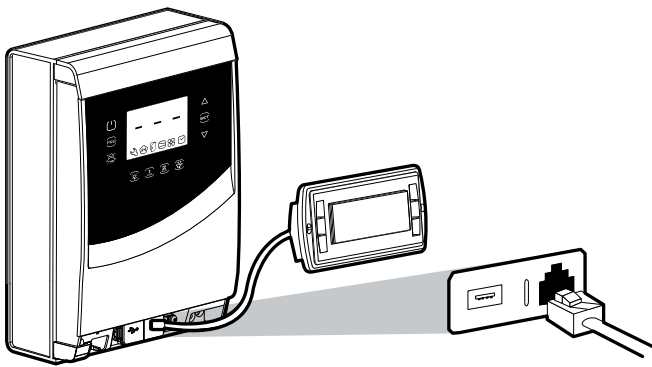


Fig. 2.u

### 2.13 Upload/download parameters(USBmemory key)

The USB memory key must be placed in the connector accessible after removing the lower frame. Using the USB memory key you can:

1. download the parameters set (r01...r10): control saves inside the key the 10 parameters set;
2. upload the parameters set (r01...r10): control loads from the key the 10 parameters set);

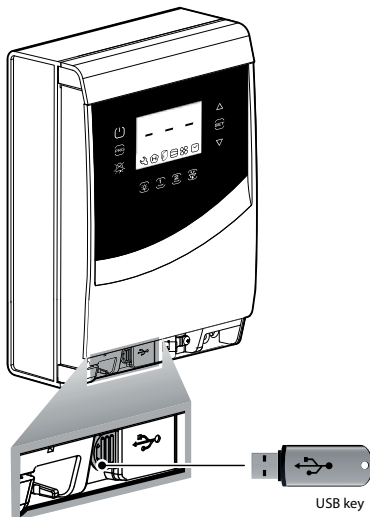
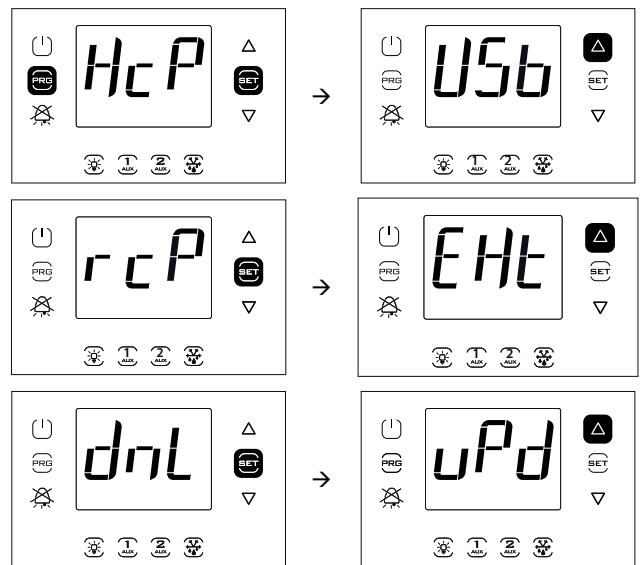


Fig. 2.v

Procedure:

1. remove the lower frame and insert the USB memory key. The red and green LED beside the key will light up once in sequence to indicate the recognition by the unity of the USB memory key;
2. bring the control to OFF to upload (to copy the configurations from the USB key to the controller); to download (to copy the configurations from the controller to the USB key), the controller can be in ON status;
3. press at the same time Prg and Set for 2 s and access the multifunction menu: the message "HcP" will appear;
4. press "UP" until reaching the entry "USB";
5. press "Set";
6. choose whether you want to DOWNLOAD the parameters (= dnL), to UPLOAD them (=uPd) or to exit the page (EXT);
7. press "Set"; the green LED will light up and will remain lit to indicate that the upload / download of parameters occurred; if, for some reason, the procedure should not be successful, the red LED will turn on;
8. extract the key. The LED turns off. The file is ".txt" type, and it can be displayed on the computer.



➡ Note: the figure refers to the screens on models with single row display, P/Ns WB000S\*. In models with two rows, P/Ns WB000D\*, as well as the message indicated, during navigation the display shows the scrolling message "recipes in USB device" on the second row.

➡ Note: the download and upload operations, as well as the 10 lists of parameters, also copy all the other parameters (one value only for all 10 lists).

### 3. USER INTERFACE

The front panel contains the display and keyboard, made up from 10 or 11 keys (depending on the model), which, pressed individually or together, allow to perform all of the controller programming operations. The accessory UltraCella Service terminal, accessory terminal, allows the commissioning of the control system via a guided procedure (Wizard) and also programming the parameters with a contextual help that explains the various functions.

#### 3.1 Display

On the LED display is shown the temperature range from -50 °C (-58 °F) to +150 °C (302 °F). The resolution of the tenth for temperatures in the range -19,9...99,9. In case of alarm the value of the probe is displayed in alternance with the codes of the active alarms. During programming, it displays the codes that identify the parameters and their value.

**Note:** you can select the standard display by properly configuring parameter /t1 (/t1 and /t2 for double digit models).

Front panel for single row display models  
cod. WB000S\*

Front panel for double row display models  
cod. WB000D\*

UltraCella Service Terminal (accessories)

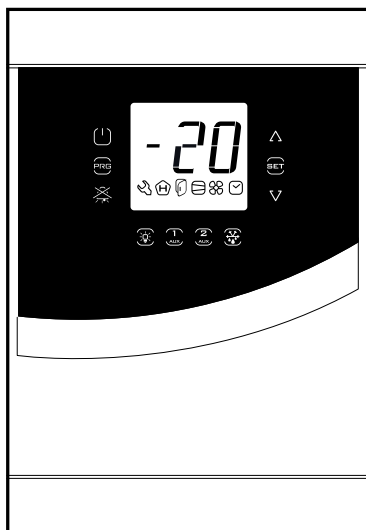


Fig. 3.a

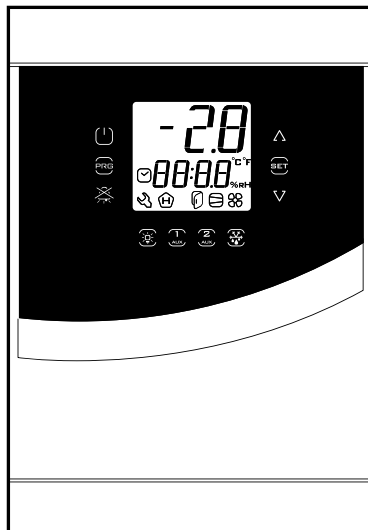


Fig. 3.b

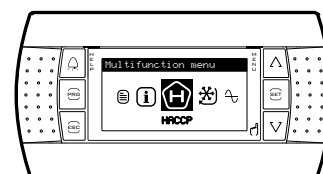











Fig. 3.c

Icons table on models with single row display P/Ns WB000S\*

Icon	Function	Normal operation			Note
		ON	OFF	Flashing	
	Technical support			Alarms, for example alarm due to EEprom or probe fault	Serious problem detected. Please contact technical service
	HACCP	HACCP function enabled	-	HACCP alarm saved (HA and/or HF)	
	Door	Door open	Door Close	Door open and door alarm active	
	Compressor	On	Off	Waiting for activation	Blinks when the activation of the compressor is delayed by safety times.
	Fan	On	Off	Waiting for activation	Blinks when the activation of the compressor is delayed by safety times.
	Clock	On if a scheduled defrost is requested			










Tab. 3.a

Icons table on models with two rows display P/Ns. WB000D\*

Icon	Function	Normal operation			Note
		ON	OFF	Flashing	
	Technical support			Alarms, for example alarm due to EEPROM or probe fault	Serious problem detected. Please contact technical service
	HACCP	HACCP function enabled	-	HACCP alarm saved (HA and/or HF)	
	Door	Door open	Door Close	Door open and door alarm active	
	Compressor	On	Off	Waiting for activation	Blinks when the activation of the compressor is delayed by safety times.
	Fan	On	Off	Waiting for activation	Blinks when the activation of the compressor is delayed by safety times.
	Clock	On if a scheduled defrost is requested			
	Celsius degrees	Temperature visualization in Celsius degrees	-	.	
	Fahrenheit degrees	Temperature visualization in Fahrenheit degrees	-		
	humidity percentage	Humidity visualization	-		

Tab. 3.b

### 3.2 Keyboard

Key	Normal operation		Blink
	Pressing the individual key	Combined pressure with other keys	
 On/Off	<ul style="list-style-type: none"> <li>Pressed for 2 s, turns the control OFF</li> <li>Pressed for 2 s, turns the control ON</li> </ul>		
	<ul style="list-style-type: none"> <li>ESC function, return to higher level</li> <li>Pressed for 2 s, enters the programming menu</li> </ul>	Prg + Set: if pressed at the same time for 2 s, allow access to the multifunction menu	
 ALARM	<ul style="list-style-type: none"> <li>In case of alarm: mutes the audible alarm (buzzer) and deactivates the alarm relay</li> <li>Pressed for 2 s, reset the manual reset alarms</li> </ul>		Available only in case of alarm
	<ul style="list-style-type: none"> <li>Turns the light on/off</li> </ul>		
 1 AUX	<ul style="list-style-type: none"> <li>Turns auxiliary output 1 on/off (*)</li> </ul>		Flashing for 5 seconds: attempt to activate auxiliary output 1 from button, yet output has different configuration
 2 AUX	<ul style="list-style-type: none"> <li>Turns auxiliary output 2 on/off (*)</li> </ul>		Flashing for 5 seconds: attempt to activate auxiliary output 1 from button, yet output has different configuration
 DEF	<ul style="list-style-type: none"> <li>Activates/deactivates manual defrost</li> </ul>		Awaiting activation
 SET	<ul style="list-style-type: none"> <li>Set point setting</li> <li>Value setting</li> </ul>	Prg + Set: if pressed at the same time for 2 s, allow access to the multifunction menu	Indicates that the set point is not that the value set for parameter St but rather defined by one of the following algorithms: <ul style="list-style-type: none"> <li>Change set point from digital input (St+r4 and/or StH+r5)</li> <li>Change set point from time band (St+r4 and/or StH+r5)</li> <li>Set point ramps (variable set point)</li> </ul>
 UP/DOWN	<ul style="list-style-type: none"> <li>Value increase/ decrease (flashing)</li> </ul>		Light on steady signals that AUX3 and/or AUX4 outputs are active. See paragraph 6.20 for further information.

Tab. 3.c

(\*) To activate outputs AUX1 / AUX2 by button, set H1/H5=2. If parameters are not set, if AUX1/AUX2 key are pressed, they blink for 5 seconds

### 3.3 Programming

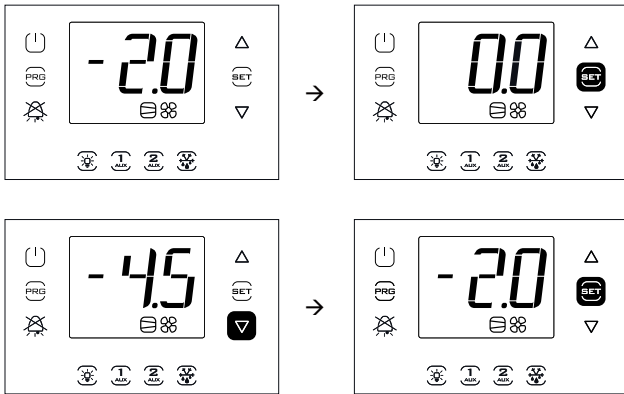
The parameters can be modified using the keyboard. Access to the configuration parameters is protected by a password that prevents unwanted modifications or access by unauthorised persons. With the password you can access and change all the parameters of the control.

**Note:** in the LED display model the keys are illuminated according to the menu where the user is operating, in order to facilitate navigation.

#### 3.3.1 Changing the set point

In order to change the set point St (default =0°C):

1. the control system displays the standard display visualization;
2. press Set for 2 s: on the display appears the current value of the set point;
3. press UP/DOWN to reach the desired value;
4. press Set to confirm the new set point value. The control returns to standard display visualization.

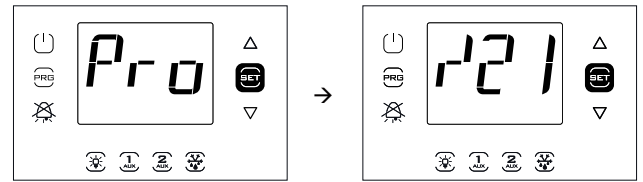
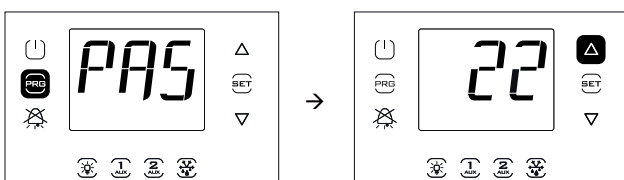


**Note:** the figure refers to the screens on models with single row display, P/Ns WB000S\*. In models with two rows, P/Ns WB000D\*, as well as the message indicated, during navigation the display shows the scrolling message "Setpoint" on the second row

#### 3.3.2 Modification of the parameters (for models with single digit display cod. WB000S\*)

Procedure:

1. to modify the parameters, first switch the controller OFF (press ON/OFF button);
2. press Prg for 2 s: on the display appears the message "PAS" - password request;
3. press UP/DOWN and insert the password: 22. If you press Set, the code of the first parameters category will appear: Probes (see the following table and parameters table);
4. press Set: the first parameter of the category will appear: /21;
5. press UP/DOWN until reaching the parameter to be modified;
6. press Set key to display the parameter value;
7. press UP/DOWN to reach the desired value;
8. press Set to confirm the new value and return to parameter code display;
9. repeat the operations from 5) to 8) to change other parameters;
10. press Prg to return to higher level of the parameters categories and UP/DOWN to pass to the next category: Ctl. Repeat steps from 4) to 8) to access the category and change other parameters;
11. press one or more times Prg to exit the parameters modification procedure and return to standard display visualization.



**Note:** in the parameters or set point modification procedures, the new value is saved every time the Set key is pressed.

Category	Text	Category	Text
Probes	Pro	Clock	rtc
Control	CtL	Door and light	doL
Compressor	CMP	Recipes	rcP
Defrost	dEF	Generic functions	GEF
Alarms	ALM	EVD EVO	EVO
Fan	FAn	EVDice	ICE
Configuration	CnF	Three-phase modules	3PH
HACCP	HcP	Output configuration	OUT
		Humidity management	HUM

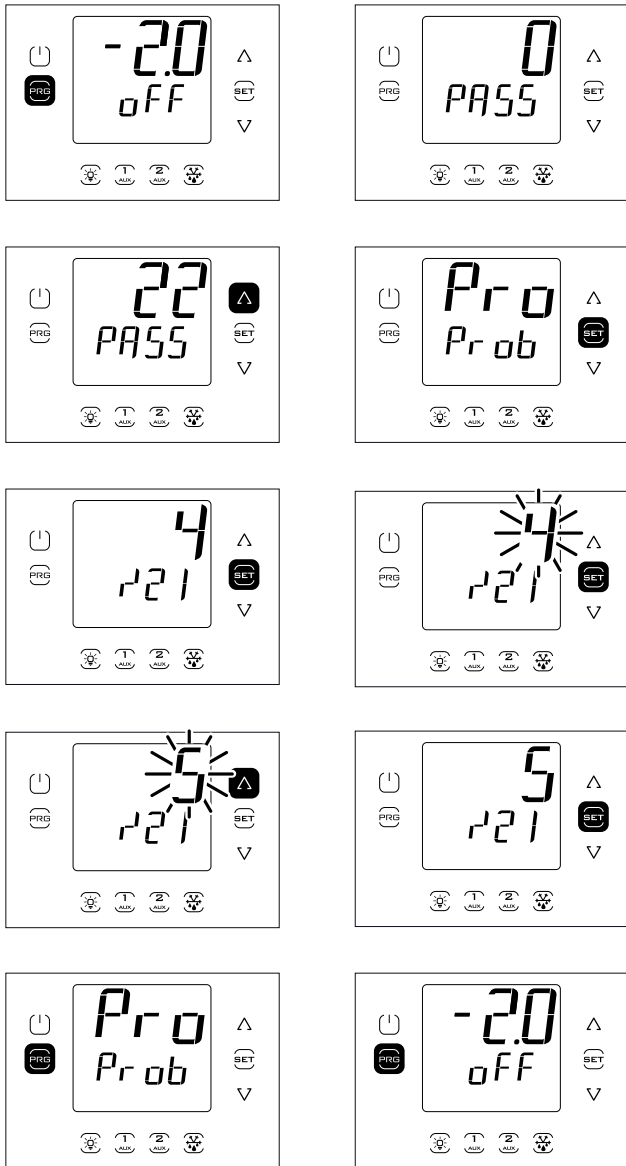
Tab. 3.d

**Note:** if no key is pressed, after about 120 s the control automatically returns to standard display..

#### 3.3.3 Modification of the parameters (for models with double digit display cod. WB000D\*)

Procedure:

1. to modify the parameters, first switch the controller OFF (press ON/OFF button);
2. press Prg for 2 sec: the second row of the display will show "PASS" (password required);
3. press UP/DOWN to enter the password: 22;
4. press Set; the second row of the display will scroll the name of the first category of parameters: Probes (see the previous table and the parameter table);
5. press Set: the second row of the display will scroll the code and description of the first parameter in the category: /21 – Probe1 meas. stab.; the first row of the display will show the current value of the parameter;
6. press Set: the value on the first row of the display flashes, to indicate that the value can be modified;
7. press UP/DOWN until reaching the desired value;
8. press Set to confirm the new value; the value will stop flashing;
9. press UP/DOWN to scroll the other parameters;
10. repeat steps 6) to 9) to modify other parameters;
11. press Prg to return to the top level of parameter categories, or UP/DOWN to move the next category: Ctl (Control). Then repeat steps from 5) to 9) to access the category and modify other parameters;
12. press Prg once or more than once to exit the parameter setting procedure and return to the standard display.



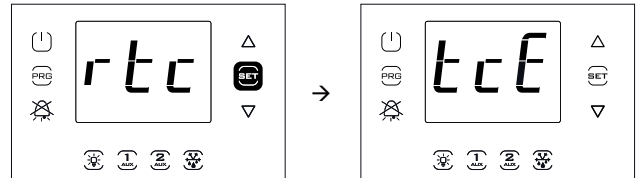
**Note:** in the parameters or set point modification procedures, the new value is saved every time the Set key is pressed.

**Note:** if no key is pressed, after about 120 s the control automatically returns to standard display.

**3.3.4 Example 1: current date/time setting**

- Procedure:
- access the parameters modification menu as described in the relative paragraph;
  - enter category "rtc";
  - select parameter "tcE" and set it to 1 to enable the date exchange;
  - press UP 2 times and then set the parameters regarding the year (Y), month (M), day of the month (d), hour (h), minutes (n) (see table below);
  - press UP, select tct parameter and set it from 0 to 1 or from 1 to 0 to perform the data/ time change;
  - select again parameter tcE and set it to 0;
  - press one or more times Prg to save the date/ time and return to standard display.

Par.	Description	Def	Min	Max	UoM
tcE	Enabling date modification procedure 0/1=No/Yes	0	0	1	-
tct	Date/ time change Action on change 0→1 or 1→0	0	0	1	-
y	Date/ time: year	0	0	37	-
M	Date/ time: month	1	1	12	-
d	Date/ time: day of the month	1	1	31	-
h	Date/ time: hour	0	0	23	-
n	Date/ time: minute	0	0	59	-

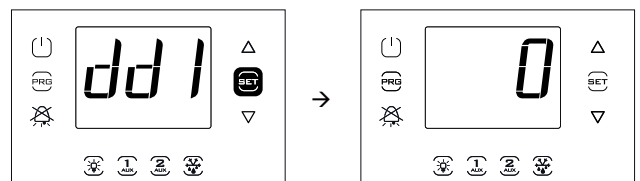


**Note:** the figure refers to the screens on models with single row display, P/Ns WB000S\*. In models with two rows, P/Ns WB000D\*, as well as the message indicated, during navigation the display shows with a scrolling message, parameter code and description: "tce - enable data modification".

**3.3.5 Example 2: set the scheduled defrosting periods**

- Procedure:
- access the parameters modification menu as described in the relative paragraph;
  - enter category "rtc";
  - press UP and select the parameters "ddi (i = 1...8)" to select the frequency of the ith defrost, based on the indications in the table below;
  - press UP and pass to the defrost hour and minute;
  - press once or more times Prg to save and return to standard visualization.

0	ith defrosting disabled
1...7	Monday...Sunday
8	From Monday to Friday
9	From Monday to Saturday
10	Saturday and Sunday
11	Daily



**Note:** the figure refers to the screens on models with single row display, P/Ns WB000S\*. In models with two rows, P/Ns WB000D\*, as well as the message indicated, during navigation the display shows with a scrolling message, parameter code and description: "dd1 - defrost1-day".



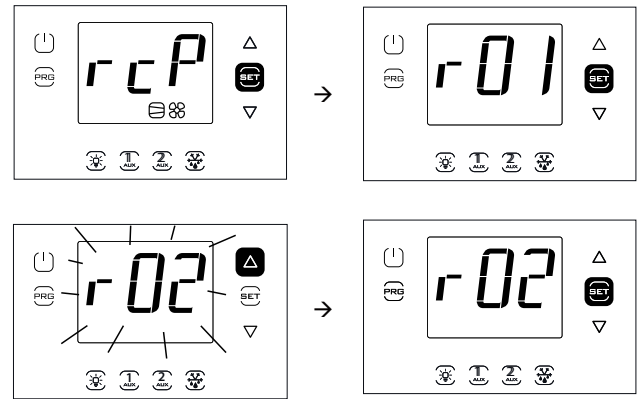
### 3.4 Procedures

#### 3.4.1 Parameter set selection

The control can work with 10 sets of parameters, pre-set in the factory by Carel, but modifiable to suit your requirements, indicated with r01 r10 (recipe 1 ... recipe 10);

In order to select the current parameters set (control in OFF):

1. from parameters modification menu, access the category "rcP" and press Set; the message "bni" will appear; press Set again; the message "r0i" will appear where "r0i" ranges from 1 to 10 and indicates the currently active configuration on UltraCella;
2. press UP/DOWN to select the parameters set to be loaded; you can choose between r01...r10; for example r02 (figure);
3. Press Set to confirm. The control system loads the chosen parameters set;
4. Press once or more times Prg to return to standard display..



**Note:** the figure refers to the screens on models with single row display, P/Ns WB000S\*. In models with two rows, P/Ns WB000D\*, as well as the message indicated, during navigation the display shows the scrolling message "bni - recipe index now active" on the second row.

Param	Configurations									
	Std CAREL	Red meat	Poultry	Fish	Vegetables	Fruit	Summer and tropical fruit	Frozen	Restaurant - fresh food	Bakery
	r01	r02	r03	r04	r05	r06	r07	r08	r09	r10
/4	0	0	0	0	0	0	0	0	0	0
/t2	6	4	4	4	4	4	11	4	4	4
/A2	1	1	1	1	1	0	0	1	1	1
/A3	0	0	0	0	0	0	0	0	0	0
/A4	0	0	0	0	0	0	0	0	0	0
/A5	0	0	0	0	1	1	1	0	0	0
St	0	-0,5	0	1	4	4	10	-22	3	-20
rd	2	2	2	2	2	2	2	2	2	2
StH	90	90	90	90	95	95	85	90	90	90
rdH	5	5	5	5	5	5	5	5	5	5
r1	-50	-5	-5	-5	0	0	5	-25	0	-25
r2	60	10	10	10	10	10	15	-15	10	-10
r3	0	0	0	0	0	0	1	0	0	0
c11	4	4	4	4	4	4	4	4	4	4
d0	0	0	0	0	0	2	0	0	0	0
dl	8	12	12	12	24	24	8	15	13	15
dt1	4	20	15	10	8	4	4	15	10	15
dP1	30	60	60	60	45	30	30	60	90	60
AL	0	4	4	4	4	5	5	10	4	10
AH	0	5	5	10	5	5	5	6	5	6
Ad	120	60	60	120	60	60	60	60	60	60
A5	0	0	0	0	0	0	0	0	0	0
A9	0	0	0	0	0	0	0	0	0	0
F0	0	1	1	1	0	0	0	0	0	1
F1	5	-8	0	0	5	5	5	5	5	-22
F2	30	30	30	30	15	15	10	30	30	30
F3	1	1	1	1	0	0	0	1	0	1
F4	1	1	1	1	1	1	1	1	1	1
H1	1	0	0	0	0	0	0	0	0	0
H5	1	2	2	2	15	15	15	3	2	3
HO1	0	0	0	0	0	0	0	0	0	0
c12	5	5	5	5	5	5	5	5	5	5
d8d	30	30	30	30	30	30	30	30	30	30
tLi	120	120	120	120	120	120	120	120	120	120
A4	0	0	0	0	0	0	0	0	0	0

Tab. 3.e

For all other parameters not included in this table, the default values will be used for all configurations, as shown in chap.7 Parameter table.



### 3.4.2 Parameters set to default values

In order to set all parameters sets to the factory values (default):

1. from parameters modification menu, access the category "rcP" and press Set; the message "r0i" will appear, where "i" indicates the currently active configuration ;
2. press UP/DOWN and display the message "bnr";
3. press Set: the message "no" will appear;
4. press UP/DOWN: the message "Std" will appear;
5. press set: the control system brings all parameters sets to default values;
6. press one or more times Prg to return to standard display.

**Note:** in this manner all the modifications are erased and the original factory values are restored to the default ones, indicated in parameters table.

### 3.4.3 Defrost

In order to activate the defrost by temperature, the defrost probe must detect a temperature lower than the temperature relative to defrost end (par. dt1). The defrost by time is activated setting dl parameter to a value >0.

Procedure:

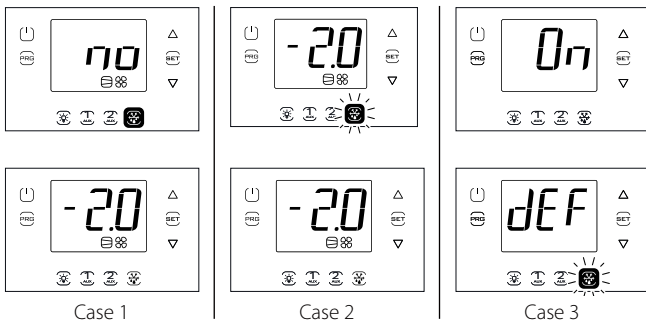
1. press DEF. There can be 3 cases:
2. if the defrost probe detects a temperature greater than the value of the defrost end temperature, the control displays the message "no" and the defrost is not activated;
3. if there are protections in progress, the control waits before entering the defrost. The DEF button blinks and when conditions permit, the control enters the defrost;
4. control comes into defrost, it shows the message "On". The DEF key is lit and the defrost output is enabled. The display depends on parameter d6.

Par.	Description	Def	Min	Max	UoM
d6	Terminal display during defrost 0 = Temperature alternated with dEF 1 = Last temperature shown before defrost 2 = dEF	1	0	2	-

#### ACTIVATION MANUAL DEFROST



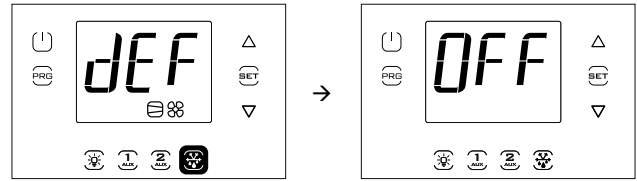
Request a manual defrost



**Note:** The Figures refer to the screens on models with single row display, P/Ns WB000S\*. In models with two rows, P/Ns WB000D\*, the message "no" and "On" appear on the second row of the display.

#### DEACTIVATION MANUAL DEFROST

Press DEF: message "Off" will appear and the control ends the defrost



**Note:** The Figures refer to the screens on models with single row display, P/Ns WB000S\*. In models with two rows, P/Ns WB000D\*, the message "Off" appears on the second row of the display.

### 3.4.4 AUX1/AUX2/Light

In order to activate/deactivate the digital outputs AUX1/AUX2 (auxiliary mode outputs) from keyboard set the parameters H1/H5=2. The light output is fixed and cannot be configured.

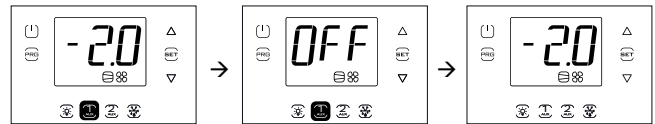
#### ACTIVATION

Press keys AUX1/AUX2/Light: message "On" will appear and the control activates the relative output.



#### DEACTIVATION

Press keys AUX1/AUX2/Light: message "Off" will appear and the control deactivates the relative output.



**Note:** if output AUX1/2 was not enabled by setting H1/H5 = 2, the relative key blinks to signal that the output is not active. However, the messages "On" and "Off" will appear

**Note:** The Figures refer to the screens on models with single row display, P/Ns WB000S\*. In models with two rows, P/Ns WB000D\*, the message "On" and "Off" appear on the second row of the display.

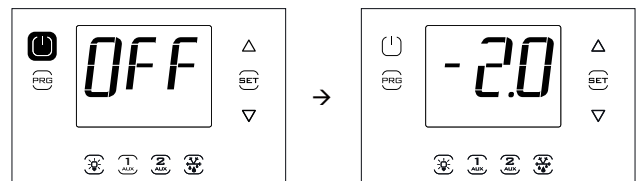
### 3.4.5 On/Off

In order to turn off the control from keyboard:

- press On/Off for 2 s.

The display will alternate Off to the standard display.

The key On/Off lights up and any active output relay will be deactivated.

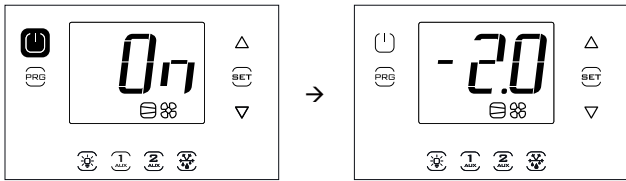


**Note:** The Figures refer to the screens on models with single row display, P/Ns WB000S\*. In models with two rows, P/Ns WB000D\*, the message "On" and "Off" appear on the second row of the display.

In order to turn on the control from keyboard:

- press On/Off for 2 s.

"On" will appear on the display and then control returns to the standard display. The output relay will be re-activated.



**Note:** The Figures refer to the screens on models with single row display, P/Ns WB0005\*. In models with two rows, P/Ns WB000D\*, the message "On" and "Off" appear on the second row of the display.

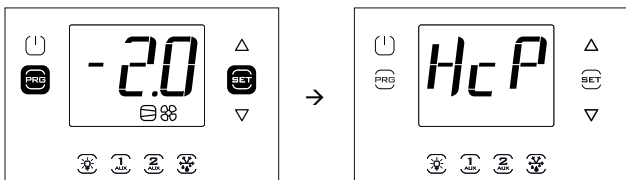
### 3.5 Multifunction menu

The multifunction menu allows you to access:

- "HcP": HACCP alarms display, type HA and HF alarms and reset;
- "cc": continuous cycle activation/deactivation;
- "rEc": display maximum and minimum temperature, cancellation and re-start recording;
- "I/O": input/output: displaying the temperature read by the probe and digital input status;
- "USB": USB key;
- "InF": information
- "Log": datalogging function
- "SOF" UltraCella software update

Procedure:

1. press Prg and Set for 2 s; the first menu will appear: HcP;
2. press UP/DOWN to view other entries;
3. press Set to enter: follow the steps described in the following sections for the relative explanations;
4. Press one or more times Prg to return to standard display.



**Note:** the figure refers to the screens on models with single row display, P/Ns WB0005\*. In models with two rows, P/Ns WB000D\*, as well as the message indicated, during navigation the display shows the scrolling message "Menu" on the second row.

#### 3.5.1 HACCP alarms display

For explanations regarding HACCP alarms, consult chapter "Alarms". In the multifunction menu you can see the date and time of the last 3 alarms HA and HF. After entering the multifunction menu (see previous par.), select with UP / DOWN the message "HcP".

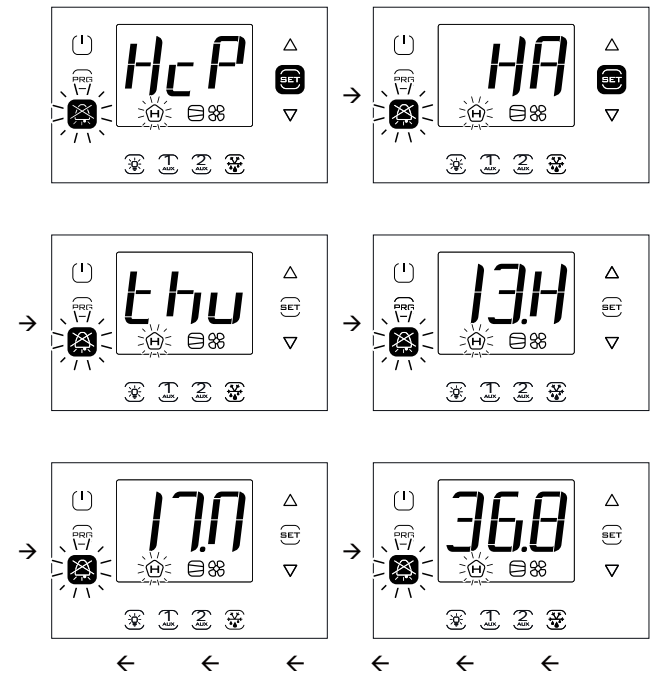
Procedure:

1. press Set, and then UP / DOWN to display the parameters in the following table: you can see the number of alarms, the relative date and you can also cancel the alarms;
2. press Set to display the alarm date and time;
3. press Prg until you return to standard display.

Par.	Description	Def	Min	Max	UoM
HA	Date/time of last HA alarm	0	-	-	-
HA1	Date/time of penultimate HA alarm	0	-	-	-
HA2	Date/time of third from last HA alarm	0	-	-	-
Han	Number of HA alarms	0	0	15	-
HF	Date/time of last HF alarm	0	-	-	-
HF1	Date/time of penultimate HF alarm	0	-	-	-
HF2	Date/time of third from last HF alarm	0	-	-	-
HFn	Number of HF alarms	0	0	15	-
Hcr	HACCP alarms cancelling Action on variation 0→1 or 1→0	0	0	1	-

Each alarm is displayed with scrolling text, which contains the day of week, hour, minute, and the temperature that caused the alarm. This is a list (FIFO) in which are stored only the last 3 alarms. Instead, the alarm counters (HAn, HFn), after reaching 15, they stop.

**Example:** HA alarm triggered Thursday at 13:17, with detected temperature of 36.8 °C.



**Note:** the figure refers to the screens on models with single row display, P/Ns WB0005\*. In models with two rows, P/Ns WB000D\*, as well as the message indicated, during navigation the display shows the scrolling message "HACCP Alarms" on the second row.

#### 3.5.2 Continuous cycle

For explanation of continuous cycle, see chapter 6.

In order to activate the continuous cycle

- the control must be on;
- the value of the parameter cc must be >0.

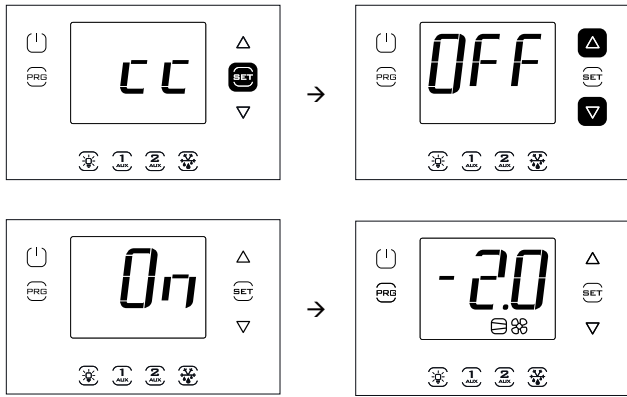
Par.	Description	Def	Min	Max	UoM
cc	Continuous cycle duration	0	0	15	hour

After entering the multifunction menu (see previous par.), select with UP / DOWN the message "cc".

#### ACTIVATION

Procedure:

1. press Set; the message "OFF" will appear (continuous cycle disabled);
2. press UP/DOWN: the message "ON" appears;
3. after about 1 s the control returns to standard display and the compressor icon appears, to show the activation of the function.



**Note:** the figure refers to the screens on models with single row display, P/Ns WB000S\*. In models with two rows, P/Ns WB000D\*, as well as the message indicated, during navigation the display shows the scrolling message "Continuous cycle" on the second row.

**DEACTIVATION**

Follow the same activation steps and set "OFF".

**Note:** the activation of the continuous cycle function does not appear on display in standard mode.

**3.5.3 Maximum and minimum temperature monitoring**

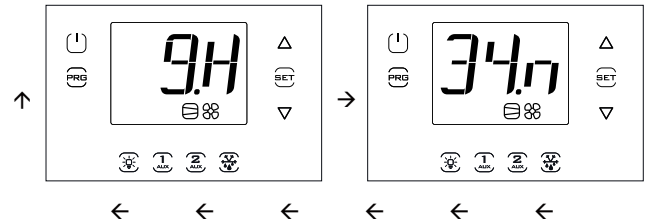
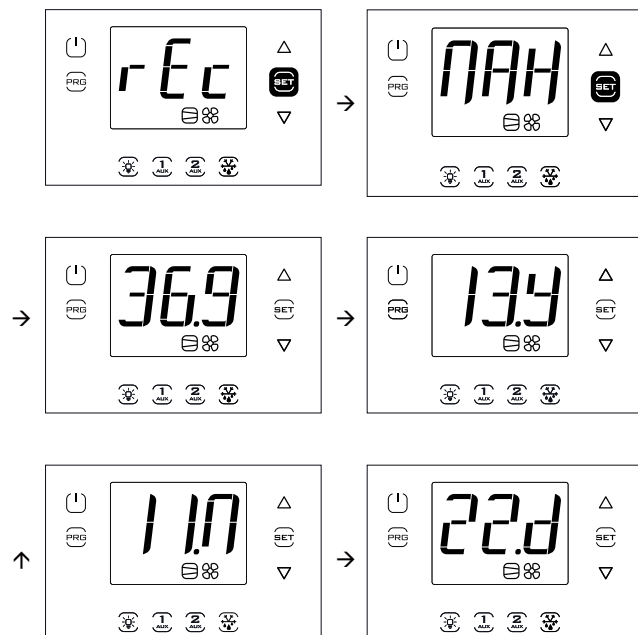
The control allows you to continuously record the minimum and maximum temperature measured by the control probe. The monitoring is always active. The values can be reset, as described below.

After entering the multifunction menu (see previous par.), select with UP / DOWN the message "rEc".

Procedure:

- press Set; the message "MAX" will appear (maximum registered temperature); in order to see the maximum temperature, registration date and time pass to point 3 or:
- press UP/DOWN: the message "Min" appears (minimum temperature registered);
- press Set: the maximum/minimum recorded temperature will appear along with the date/time of record (y=year, m = month, d = day, h = hour, m = minutes. Press UP to cancel (both temperatures), appears RES and the control exits the menu, or press Prg for more than once and exit the display.

Example: maximum registered temperature 36.9°C on 22/11/2013 at 9.34.



**Note:** by pressing UP you will cancel both the maximum and the minimum recorded temperature.

**Note:** the Figures refer to the screens on models with single row display, P/Ns WB000S\*. In models with two rows, P/Ns WB000D\*:

- MAX --> Max temp recorder (scrolling)
- 36,9 --> Max
- 13.Y --> year
- 11.M --> month
- 22.d --> day
- 9.H --> hour
- 34.m --> minute

**3.5.4 Input/output status display**

After entering the multifunction menu (see previous par.), select with UP / DOWN the message "I/O".

Procedure:

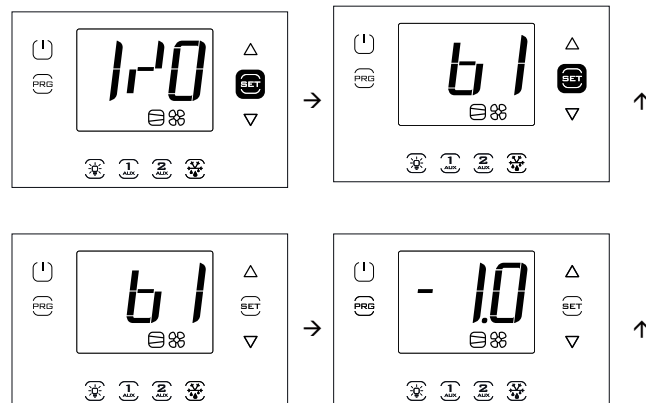
- Press Set: the message "b1" appears regarding the probe B1;
- Press Set once again: the value read on probe B1 will appear alternating with the message b1;
- Press Prg to return to upper level;
- Press UP/DOWN and repeat steps 1)...3) to display the inputs/ outputs indicated in table;
- Press one or more times Prg to return to standard display

Text	Description	Text	Description
b1	Analogue input 1	do6	Digital output 6
b2	Analogue input 2	Y1	Analog output 1
b3	Analogue input 3	ESu	EVD EVO suction temp.
b4	Analogue input 4	ESA	EVD EVO evap. temp.
b5	Analogue input 5	ESH	EVD EVO superheat
di1	Digital input 1	ISu	EVD ICE suction temperature
di2	Digital input 2	ISa	EVD ICE evaporation temperature
di3	Digital input 3	ISH	EVD ICE superheat
do1	Digital output 1	U1	Defrost probe Sd1 (3PH model)
do2	Digital output 2	U2	Auxiliary defrost probe Sd2 (3PH model)
do3	Digital output 3	U3	Condenser probe Sc (3PH model)
do4	Digital output 4	dU4	Motor protector (3PH model)
do5	Digital output 5	dU5	High/low pressure switch or Kriwan alarm (3PH model)

Tab. 3.f

**Note:** the opened digital inputs/outputs are displayed along with the message "oP" (=open), those closed with "cLo" (=closed).

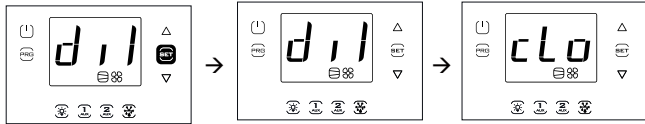
Example 1: probe B1 measures the temperature of -1.0 °C..



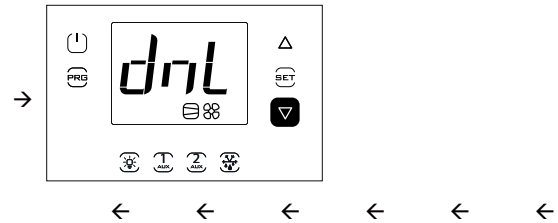
**Note:** the figure refers to the screens on models with single row display, P/Ns WB000S\*. In models with two rows, P/Ns WB000D\*, as well as the message indicated, during navigation the display shows the

scrolling message "Probe1 status" on the second row".

**Example 2:** digital input 1 is closed.



**Note:** the figure refers to the screens on models with single row display, P/Ns WB0005\*. In models with two rows, P/Ns WB000D\*, as well as the message indicated, during navigation the display shows the scrolling message "Digital input 1 status" on the second row.



**Note:** the figures refer to the screens on models with single row display, P/Ns WB0005\*. In models with two rows, P/Ns WB000D\*, as well as the message indicated, during navigation the display shows the scrolling message "recipes in USB device" on the second row

**Note:** the download and upload operations, as well as the 10 lists of parameters, also copy all the other parameters (one value only for all 10 lists).

### 3.5.5 USB memory key

#### Parameters upload/download

Preliminary operations:

1. remove the lower frame and insert the USB memory key;
2. set the control to OFF.

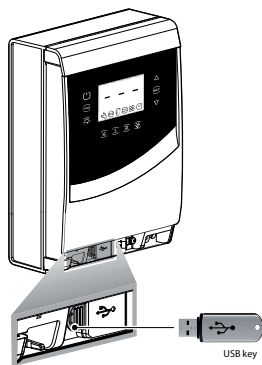


Fig. 3.d

After entering the multifunction menu (see previous par.), select with UP / DOWN the message "USB".

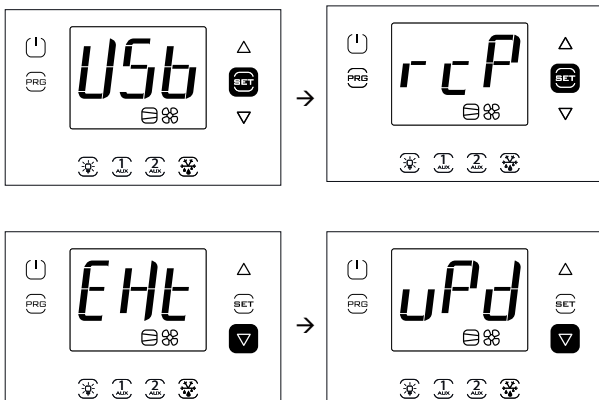
Procedure:

Press Set: the following commands will appear by scrolling UP/DOWN:

- rcP: press Set to confirm;
- EXt: press Set to exit;
- dnL: press Set, the control saves inside the key the 10 parameters set: r01...r10;
- uPd: press Set, the control loads from the key the 10 parameters set: r01...r10;

**Note**

- the parameters are saved in a text file type .txt, which can be viewed on the computer;
- for information regarding the switching of the LEDs, see chapter 2.10.



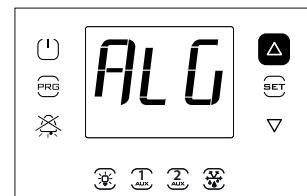
#### Download saved alarms

Starting from software release 1.5, the last 64 alarms activated and saved on UltraCella can be downloaded to a USB flash drive, in order from the most recent to the oldest, in csv format. When the 64th alarm is saved, the next one will overwrite the oldest.

Alarms that have been saved and are no longer active can only be displayed on the UltraCella Service terminal, but can be downloaded both from the terminal and the LED interface.

- Alarm log file name: AlarmLog.csv

1. remove the bottom frame and plug in the USB flash drive. The red and green LEDs on the side of the key will come on individually in sequence to indicate that the unit recognises the USB flash drive;
2. press Prg and Set for 2 sec; the first menu is displayed: "HcP";
3. press UP 4 times until reaching the "USB" menu item;
4. press Set; the first submenu is shown: "rcP";
5. press UP to access the "ALG" submenu;



6. press SET to confirm the download of the saved alarms. The message "ALG" will flash during the download procedure; at the end, "ALG" will stop flashing and the green LED next to the USB port will come on, indicating the end of the procedure; if for some reason the procedure is not successful, the alarm icon will be shown on the display;
7. unplug the key; to exit the "ALG" menu, press PRG twice.

**Note:** If for some reason the procedure is not successful, when

exiting the menu, as well as the alarm icon on the display, the error message "ALM" will be displayed. The error message will be cleared the next time the alarms are downloaded successfully or when restarting the controller.

Example: alarms saved starting 2 April 2014 at 10:30:00. The alarm log was downloaded to the USB flash drive at 16:22:45 on the same day.  
Start -> alarm activated  
Stop -> alarm reset

TIME	ID	NAME	EVENT	VAR1	VAR2
2014-04-02 T10:30:00+00:00	11	ALARM_Ed1.Active	Start		
2014-04-02 T16:22:45+00:00	11	ALARM_Ed1.Active	Stop		

**3.5.6 Information**

In the information menu you can view the software release.

After entering the multifunction menu (see chapter 3.4), select with UP / DOWN the message “InF”.

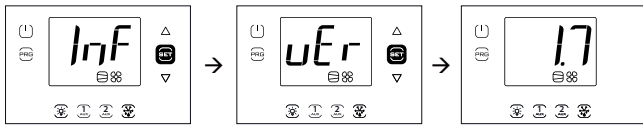


Fig. 3.e

Procedure:


1. press Set: the message “vEr” appears regarding the software revision;
2. press Set once again: the software revision will appear (e.g. 1.7);
3. press one or more times Prg to return to standard display .

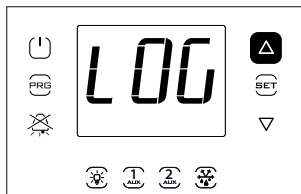
**Note:** the figure refers to the screens on models with single row display, P/Ns WB000S\*. In models with two rows, P/Ns WB000D\*, as well as the message indicated, during navigation the display shows the scrolling message “Application version” on the second row

**3.5.7 Data logging function**


UltraCella introduces the data logging function to cold room control, offering the possibility to record the temperature or the humidity read by two probes.

How to download the file with variables recorded by UltraCella:

1. remove the bottom frame and insert the USB flash drive. The red and green LEDs next to the flash drive will come on once in sequence to indicate that the unit has recognised the USB flash drive;
2. press Prg and Set for 2 s; the first menu will be displayed: “HcP”
3. press UP or DOWN until reaching the “LoG” menu item;
4. press SET to confirm the download of the recorded variables (log file) to the USB flash drive. The message “LoG” will flash during downloading; at the end, “LoG” will stop flashing to indicate that the download has been completed; if the procedure fails for some reason, the alarm icon  will be shown on the display;
5. remove the flash drive; to exit the “LoG” menu, press PRG and/or SET.



**Note:** the figure refers to the screens on models with single row display, P/Ns WB000S\*. In models with two rows, P/Ns WB000D\*, as well as the message indicated, during navigation the display shows the scrolling message “recorder” on the second row.

**Note:** if the procedure fails for some reason, when exiting the menu, as well as the alarm icon  the error message “LoG” will also be shown on the display. The message error will be cleared after the next correct download or when restarting the controller.

When the probes to be recorded are suitably configured through the parameters tr1 and tr2 and the sample time through the parameter trc, the unit starts recording the variables every trc minutes (sample time) for a maximum period of 2 years each. After the second year, the controller overwrites the oldest data saved.

The variables log is available as a csv file via USB flash drive, which can be analysed in Excel or other widely-available programs.

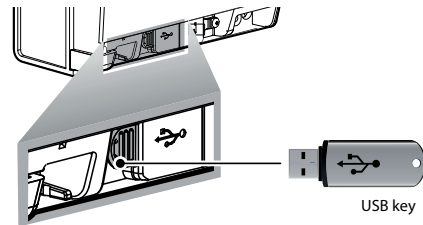


Fig. 3.f

To activate the data logging function, the probe/probes to be recorded must be configured (up to max 2) through the parameters tr1 and tr2. The sample time (for both the variables) is selectable between 2 and 60 minutes (default 5).

Par.	Description	Def	Min	Max	UoM
tr1	First temperature to be recorded selection 0 = no log 1 = Sv 2 = Sm (sonda letta da B1) 3 = Sr 4 = Sd1 5 = Sd2 6 = Sc 7 = SA 8 = Su (humidity probe)	0	0	8	-
tr2	Second temperature to be recorded selection 0 = no log 1 = Sv 2 = Sm (sonda letta da B1) 3 = Sr 4 = Sd1 5 = Sd2 6 = Sc 7 = SA 8 = Su (humidity probe)	0	0	8	-
trc	Sample time temperature recording	5	2	60	min

- Channels recorded: two probes selected through tr1 and tr2 parameters
- Start logging: as soon as parameter tr1/tr2 is set to a value >0. The instant the setting is confirmed is recorded in the log under event name “Start”
- Sample time: trc (minutes) for both the variables
- Data logging duration: depends on the sampling time trc and the maximum number of samples Nrec that UltraCella can record (209000), based on the following formula:

$$\text{Data logging duration} = \text{Nrec} * \text{trc}$$

Sampling time (trc)	Data logging duration
2 min	290 days
5 min	726 days (around 2 years)
10 min	1451 days (around 4 years)
30 min	4353 days (around 8 years)
60 min	8708 days (around 24 years)

- Data extraction: any USB flash drive available on the market can be used
- Extracted log file names: Log\_UltraCella\_1.csv for the first variable selected through the parameter tr1, Log\_UltraCella\_2.csv for the second variable selected through the parameter tr2
- Other events: as well as the “Start” event, the log also records “Stop” events (tr1=0 or tr2=0) and “Boot” (starting or restarting the controller)
- Log data format: the data is organised in columns: date (in standard ISO 8601 format) , type of event, value of the variable specify as Src1 (first variable) and Src2 (second variable)

**Example:** recording temperature probe Sv started on 2 April 2014 at 17:19:49. The data were extracted by USB flash drive at 18:10 on the same day.


TIME	EVENT	Sv_Probe
2014-04-02T17:19:49+00:00	Boot	0
2014-04-02T17:24:49+00:00		25,2
2014-04-02T17:29:49+00:00		25,0
2014-04-02T17:34:49+00:00		24,6
2014-04-02T17:39:49+00:00		24,1
2014-04-02T17:44:49+00:00		21,9
2014-04-02T17:49:49+00:00		18,8
2014-04-02T17:54:49+00:00		15,1
2014-04-02T17:59:49+00:00		12,7
2014-04-02T18:04:49+00:00		10,1
2014-04-02T18:09:49+00:00		7,3

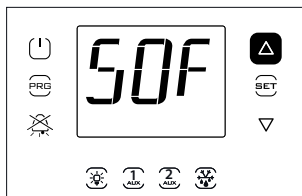
Tab. 3.g

### 3.5.8 UltraCella software update from LED display interface


Starting from software release 1.5, the UltraCella software can also be updated from the LED interface, as well as from the UltraCella Service terminal.

The **upgrade.ap1** file needed to perform the update from the UltraCella LED interface must only be supplied by CAREL personnel.

1. Create an "upgrade" folder in the main directory on the USB flash drive. Copy the **upgrade.ap1** file to the new folder;
2. remove the bottom frame and plug in the USB flash drive. The red and green LEDs on the side of the key will come on individually in sequence to indicate that the unit recognises the USB flash drive;
3. press Prg and Set for 2 sec; the first menu is displayed: "HcP";
4. press UP or DOWN until reaching the "SOF" menu item;
5. press SET to confirm the software update. The message "SOF" will flash during the update; at the end, "SOF" will stop flashing, indicating the end of the procedure; if for some reason the procedure is not successful, the alarm icon  will be shown on the display;
6. unplug the key; to exit the "SOF" menu, press PRG and/or SET

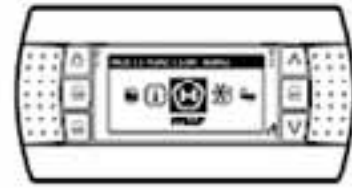


**Note:** The figure refers to navigation on models with single-row display, WB000S%. On models with double row display, WB000D%, as well as the message described above, during the update the message "Software update" also scrolls on the second row.

**Note:** If for some reason the procedure is not successful, when exiting the menu, as well as the alarm icon  on the display, the error message "SOF" will be displayed. In this case UltraCella retains the previously installed software. The error message will be cleared the next time the software is updated successfully or when restarting the controller.

### 3.6 Message language selection

The only messages that change according to the selected language are those shown on the UltraCella Service terminal screens (PGDEWB0FZ\*).



Selecting the language

1. On the UltraCella Service terminal, access the multifunction menu by pressing the UP button;
2. The HACCP icon is displayed. Press UP or DOWN until reaching the "i" icon (information);
3. Press SET to access the language setting;
4. Select the desired language (in software release 1.6, the languages available are Italian, English, German, French and Spanish) by pressing UP or DOWN. Press SET to confirm. The change is effective immediately;
5. Press ESC twice to exit the language selection menu and return to the main screen



## 4. COMMISSIONING

### 4.1 First commissioning

After wiring the electrical connections and the power supply (see installation chapter), the operations required for commissioning the UltraCella control system depend on the type of interface used. Refer to some parameters such as:

1. Set-point and differential;
2. Probes and digital inputs configuration;
3. Selection of the type of defrost and fans operation;
4. Cold room light management.

Types of interfaces:

- board with LED display: parameters configuration is performed using the display and the keyboard based on the procedure described in chap.3 "parameters change". Alternatively, you can connect the remote graphic terminal "UltraCella Service Terminal" and enter the wizard menu for first commissioning (wizard);
- USB memory key: put the control on OFF and load the programming parameters from USB memory key (uPd command, UPLOAD, see Chapter 3);
- supervisor: in order to facilitate the launch of a large number of controls UltraCella using only the supervisor you can limit the operation of the first commissioning to the serial address setting. The configuration is postponed to a later time using the supervisor.

After the configuration you can enable the control of the cold room by pressing the ON/OFF key.

### 4.2 Parameters to be set for the commissioning

Par	Description	Categ.	Def	Min	Max	UoM
St	Set point	CtL	0	r1	r2	°C/°F
rd	Differential	CtL	2.0	0.1	20	°C/°F
/P	Type B1 to B3	Pro	0	0	2	-
/A2	B2 configuration	Pro	1	0	3	-
/A3	B3 configuration	Pro	0	0	5	-
/P4	Type B4	Pro	0	0	2	-
/A4	B4 configuration	Pro	0	0	4	-
/P5	Type B5	Pro	0	0	1	-
/A5	B5 configuration	Pro	0	0	5	-
A5	Digital input configuration 2 (DI2)	ALM	0	0	15	-
A9	Digital input configuration 3 (DI3)	ALM	0	0	15	-
d0	Type of defrost	dEF	0	0	3	-
dt1	End defrost temperature, main evaporator	dEF	4.0	-50.0	200.0	°C/°F
dP1	Maximum defrost duration	dEF	30	1	250	min
dd	Dripping time after defrost (fans off)	dEF	2	0	30	min
Fd	Post dripping time (fans off)	Fan	1	0	30	min
F3	Evaporator fan during defrost 0/1=on/off	Fan	1	0	1	-
c12	Compressor safety for door switch 0 = disable door management	doL	5	0	5	min
d8d	Compressor restart time for door switch	doL	30	c12	240	min
A3	Disable door microswitch 0=enabled 1=disabled	doL	1	0	1	-
tLi	Light on with door open	doL	120	0	240	min
A4	Light management 0 = door switch + light key 1 = light key	doL	0	0	1	-
c1	Minimum time between compressor starts	CmP	6	0	30	min
c2	Minimum compressor off time	CmP	3	0	15	min
c3	Minimum compressor on time	CmP	3	0	15	min

Tab. 4.a

### 4.3 Single digit display models cod. WB000S\* commissioning

UltraCella with single row display

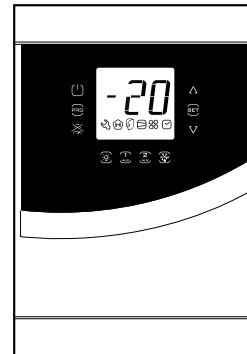
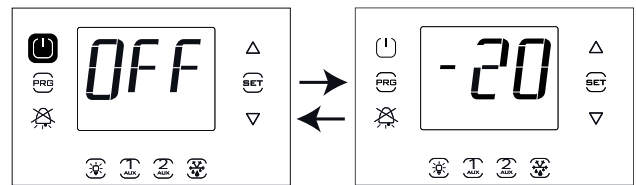
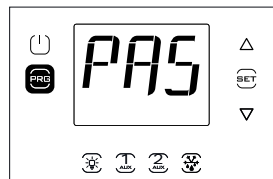


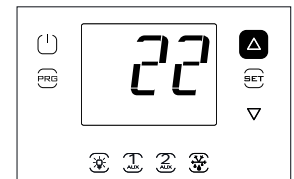
Fig. 4.a



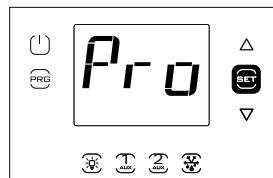
1. First switch the controller OFF (press ON/OFF).



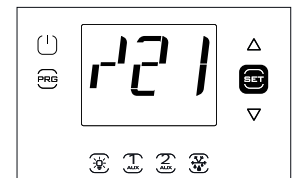
2. Press Prg for 2 sec: the password prompt is displayed (PAS).



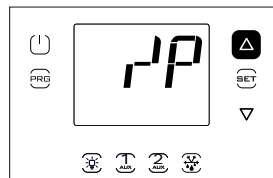
3. Press UP and enter the password: 22.



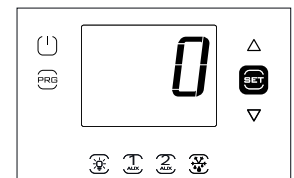
4. Press Set: the first category is displayed: Pro (Probes).



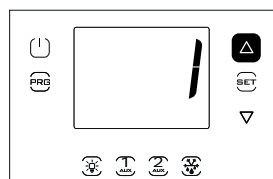
5. Press Set: the first parameter is displayed: /21.



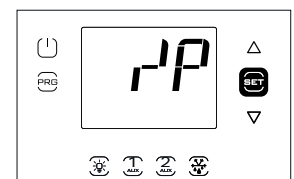
6. Press repeatedly UP to reach the parameter /P.



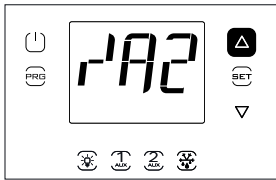
7. Press Set to set the value of the parameter (see settings in the parameter table).



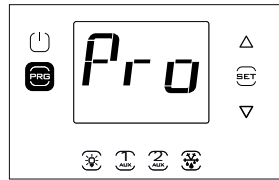
8. Press UP to modify the value.



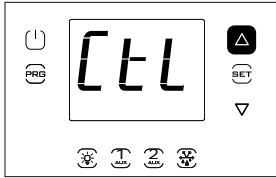
9. Press Set to confirm and return to the parameter code. The new value has now been saved on the controller.



10. Press UP to move to parameters /A2.../ A5; make any required settings.



11. Press Prg to return to the parameter categories.



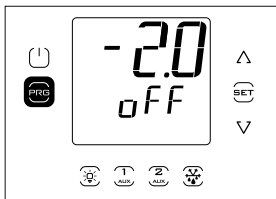
12. Press UP to move to category Ctl and follow the previous steps to set St and the following parameters.

#### 4.4 Double digit display models cod. WB000D\* commissioning

UltraCella with double row display

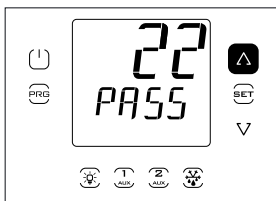
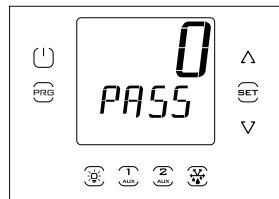


Fig. 4.b

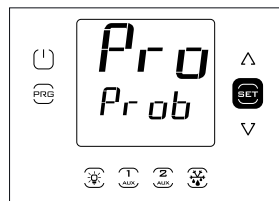


1. First switch the controller OFF (press ON/OFF).

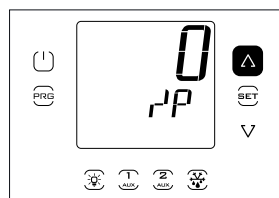
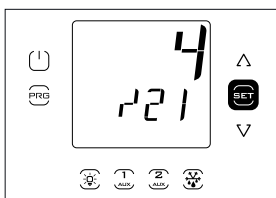
2. Press Prg for 2 sec: the second row of the display will show "PASS" (password required).



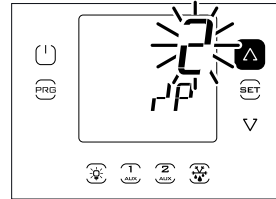
3. Press UP/DOWN to enter the password: 22.



4. Press Set; the second row of the display will scroll the name of the first category of parameters: Probes.

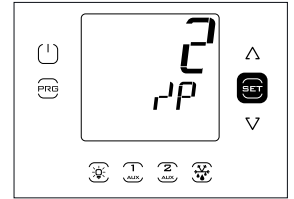


5. Press Set: the second row of the display will scroll the code and description of the first parameter in the category: /21 – Probe1 meas. stab.; the first row of the display will show the current value of the parameter

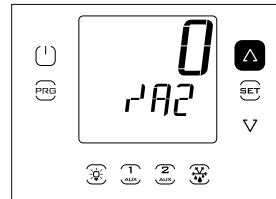


7. Press Set and UP/DOWN to set the desired value of the parameter.

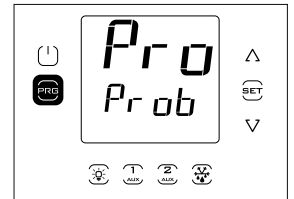
6. Press UP repeatedly until reaching parameter /P. The second row of the display will scroll the code and description of the parameter: /P – type B1 to B3; the first row of the display will show the current value of the parameter



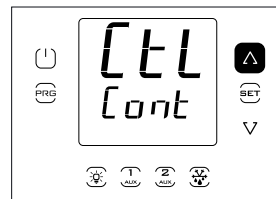
8. Press Set to confirm. The new value entered is now saved on the controller.



9. Press UP to move to parameters /A2.../A5; make any required settings.



10. Press Prg to return to the categories of parameters.



11. Press UP to move to category Ctl (the second row scrolls the name of the second category of parameters: Control) and follow the previous steps to set St and the subsequent parameters, as shown in the previous table and in the parameter table.

#### 4.5 Commissioning with UltraCella Service Terminal

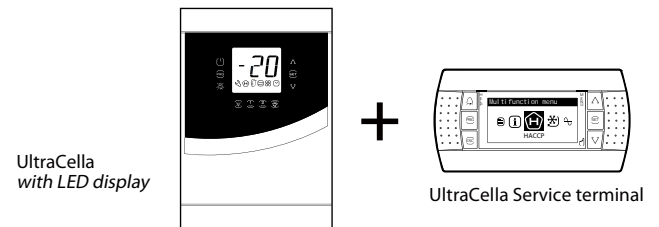


Fig. 4.c

If the UltraCella controller has never been configured, as soon as the terminal is connected, the wizard is shown automatically. The Wizard menu can also be accessed to repeat the guided commissioning procedure before the first commissioning.



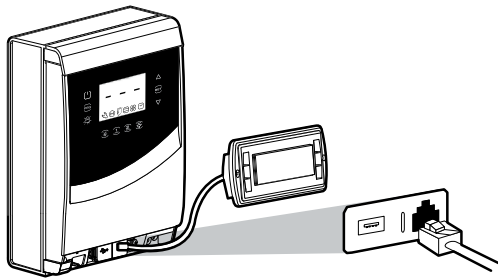


Fig. 4.d

Remove the bottom faceplate and connect the UltraCella Service Terminal to the controller.

### 4.5.1 First start - up

When starting for the first time, once the Service Tool is connected, the wizard is shown automatically. Select the desired language and then answer the questions to set the other parameters.

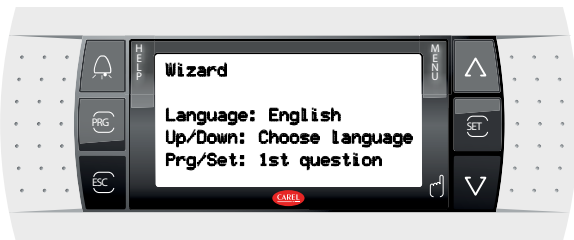


Fig. 4.e

### 4.5.2 Repeated commissioning procedure

The commissioning procedure can be repeated by accessing the Wizard menu.

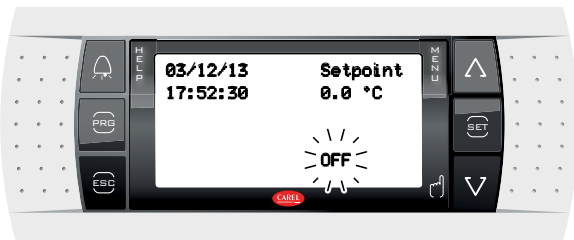


Fig. 4.f

1. Switch the controller OFF (press DOWN and select the On/Off icon; press Set twice and then UP to switch the controller OFF; press Esc twice to exit)

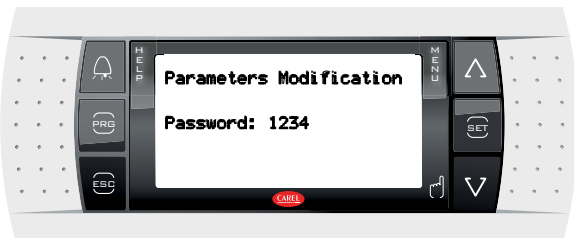


Fig. 4.g

2. To enter programming mode: Press Prg and enter the password: 1234

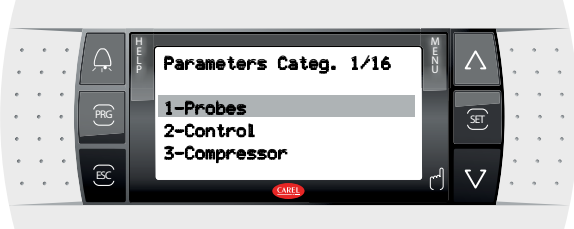


Fig. 4.h

3. Press DOWN until reaching the "Wizard" menu

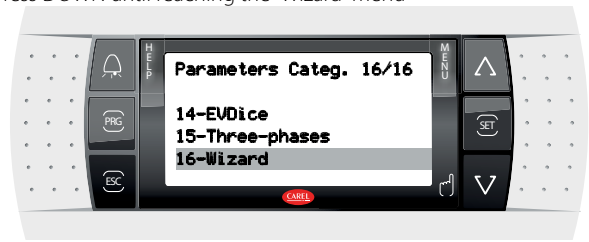


Fig. 4.i

4. Confirm by selecting Set.

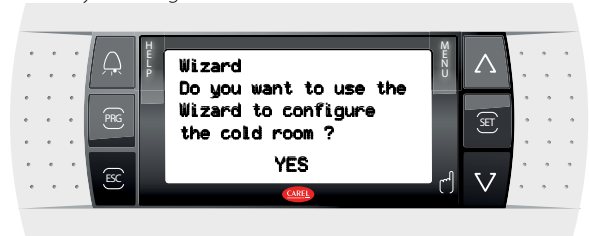


Fig. 4.j

5. Press Up and SET to enter the guided commissioning procedure.

## 4.6 Main function commissioning

### 4.6.1 Set-point and differential

The reference output is the compressor output (CMP). The set point and differential determine the compressor activation and deactivation temperatures. The control probe is the virtual probe Sv. At start-up it corresponds to probe B1. If the temperature inside the cold room is not uniform the control can be set (by placing /4> 0) to regulate on a "virtual" probe obtained from the average of two measurement points (probes B1 and B2).

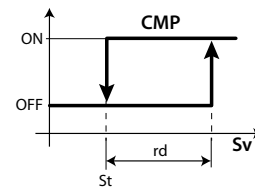


Fig. 4.k

**Key**

St	Set point
Sv	Virtual probe
rd	Differential
CMP	Compressor

**Note:** see par. "6.3 Set point" for the options related to the regulation of the control set point

### 4.6.2 Probes configuration

The UltraCella controls have a maximum of 5 analog inputs, of which 3 can be configured as temperature probes (NTC probes, NTC high temperature probes, PT1000), the fourth as temperature probe or input 0 ... 10 V, the fifth can be configured as input 4 ... 20 mA or 0...5 Vrat.

Analogue Inputs	Type
B1	NTC10 kΩ a 25°C, range -50T90°C,
B2	NTC extended range, NTC50 kΩ a 25°C, range 0T150°C;
B3	PT1000, 1000 Ω a 0°C, range -50T90°C
B4	NTC10 kΩ a 25°C, range -50T90°C, NTC extended range, NTC50 kΩ a 25°C, range 0T150°C
	0...10 V
B5	4...20 mA
	0...5Vrat
	0.5...4.5Vrat

Tab. 4.b

Below the parameters with the selection:

Par.	Description	Def	Min	Max	UoM
/P	Type B1 to B3 0 = NTC Standard Range -50T90°C 1 = NTC Enhanced Range 0T150°C 2 = PT1000	0	0	2	-
/P4	Type B4 0 = NTC Standard Range -50T90°C 1 = NTC Enhanced Range 0T150°C 2 = 0 to 10V	0	0	2	-
/P5	Type B5 0 = 4 to 20 mA 1 = 0 to 5 Vrat 2 = 0.5...4.5Vrat	0	0	1	-

### 4.6.3 Probes function assignment B1, B2, B3, B4, B5

The control, inside the cold room, can use the probes:

- outlet;
- intake;
- defrost, placed in the evaporator, preferably where the ice resides most;
- condenser, used to protect the compressor due to high discharge temperature, associated with fowling of the condenser or fan failure.

Probe B1 is configured as environment probe and its function cannot be changed.

Par.	Description	Def	Min	Max	UoM
/A2	Configuration B2	1	0	3	-
	0 Absent				
	1 Defrost probe 1 (Sd1)				
	2 Intake probe (Sr)				
3 Generic temperature probe 2					
/A3	Configuration B3	0	0	5	-
	0 Absent				
	1 Defrost probe 2 (Sd2)				
	2 Cond. probe (Sc)				
	3 Defrost probe 1 (Sd1)				
	4 Ambient probe (SA)				
5 Generic temperature probe 3					
/A4	Configuration B4	0	0	4	-
	0 Absent				
	1 Ambient temperature probe (SA)				
	2 Humidity probe				
	3 Generic temperature probe 4				
4 Generic humidity probe 4					
/A5	Configuration B5	0	0	5	-
	0 Absent				
	1 Humidity probe				
	2 Generic temperature probe 5				
	3 Generic humidity probe 5				
	4 Generic pressure probe 5				
5 Condensing pressure probe (Scp)					

For probe B4, if configured as a 0 to 10 V input (/P4=2) and for probe B5, the logical control values corresponding to the physical end scale values can be configured.

Par.	Description	Def	Min	Max	UoM
/4L	Probe 4 minimum value (only for 0...10V input)	0	-50,0	/4H	-
/4H	Probe 4 maximum value (only for 0...10V input)	100,0	/4L	200,0	-
/5L	Probe 5 minimum value	0,0	-50,0	/5H	-
/5H	Probe 5 maximum value	100,0	/5L	999	-

**Example:** if input B5 is connected to a pressure sensor with 4 to 20 mA output and a range of -1 to 9.3 bars, set

- /5L = -1.0
- /5H = 9.3

In this case, when the probe reads a value of 12 mA, the value associated with the reading of B5 will be 4.1 (middle of the scale).

### 4.6.4 Probes reading correction

The values read by the probes can be corrected by adding/removing an offset from the measure with the parameters /c1, ..., /c5.

Par.	Description	Def	Min	Max	UoM
/c1	Offset B1	0	-20.0	20.0	°C/°F
/c2	Offset B2	0	-20.0	20.0	°C/°F
/c3	Offset B3	0	-20.0	20.0	°C/°F
/c4	Offset B4	0	-20.0	20.0	°C/°F/%rH
/c5	Offset B5	0	-20.0	20.0	°C/°F/%rH/bar/psi

The offset may need to comply with HACCP requirements. In this case, the offset should be calculated using a calibrated instrument. Setting these parameters affects the measurement and the value shown on the display, and consequently may not be allowed. If in doubt, contact the food safety manager or site manager.

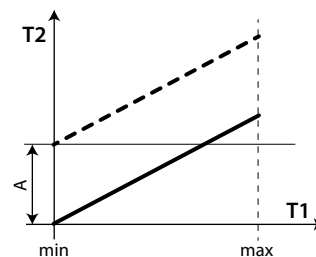


Fig. 4.1

#### Key

T1	Temperature measured by the probe
T2	Temperature measured by the probe after offset correction
A	Offset value
min, max	Measurement range

### HACCP - CAUTION

The modification of these parameters, influencing the measurement and display, may not be allowed in some applications or might require special approval because it may affect the operation of HACCP systems. If in doubt, consult the person in charge of food safety or the manager of the plant.

### 4.6.5 Digital inputs

**Note:** the digital input 1(DI1) is used by default for the door switch, however this can be configured as DI2 and DI3. If the door switch is not used (for example, not connected to DI1), it can be disabled by setting A3=1 and A11=5 (default value) or associating DI1 with another function, see Table 4b.

Par.	Description	Def	Min	Max	UoM
A3	Disable door microswitch 0= enabled 1= disabled	1	0	1	-

If A3=0 and the door microswitch is not connected, the controller will activate the "door open" icon. To prevent incorrect messages being displayed, set A3=1 or short-circuit pin 21 (DI1) to one of the GND pins.

You can link multiple contacts to multifunction digital inputs to activate various functions, such as alarm, enable / start defrost, low pressure, etc..

**Caution:** in order to ensure the safety of the unit in the event of serious alarms, all the electromechanical safety devices required to guarantee correct operation must be fitted on the unit.

Functions of digital inputs DI1, DI2 and DI3

PARAMETERS A11, A5, A9

Selection	Contacts	
	OPEN	CLOSE
0 = Not active	-	-
1 = Immediate external alarm	active	not active
2 = Do not select	-	-
3 = Enable defrost	not enabled	enabled
4 = Start defrost	not active	active
5 = Door switch	active	inactive
6 = Remote On/Off	OFF	ON
7 = Change set point (r4-r5) from sw..	inactive	active
8 = Low pressure switch	low pressure status	normal status
9 = Do not select	-	-
10 = Do not select	-	-
11 = Do not select	-	-
12 = AUX activation	deactivated	activated
13 = Do not select	-	-
14 = Continuous cycle activation	contact opening (deactivation) active/inactive	contact closing (activation) active/inactive
15 = Alarm from generic function (DI2 and DI3 only)		
16 = Start/stop defrost	stop	start
17 = Serious alarm	active	inactive

Tab. 4.c

Below are indicated the parameters used to explain the selections for A5 and A9.

1 = Immediate external alarm

**Application:** external alarm that requires immediate activation (for example, high pressure alarm or compressor thermal overload). The activation of the alarm:

- shows the message on the display (IA);
  - activates the buzzer, if enabled;
  - activates the alarm relay, if selected;
- involves the following actions on the actuators:
  - compressor: operates depending on the values assigned to parameter A6 (stop compressor on external alarm).
  - fans: continue to operate according to the fan parameters (F).



**Note:**

- when stopping the compressor, the minimum ON time (c3) is ignored.
- if more than 1 input is configured on immediate alarm, the alarm is generated when one of the inputs is opened.

2 = Do not select

3 = Enable defrost

**Application:** Any defrost request arriving when the contact is open will remain pending until the contact closes.

A11/A5/A9 = 3

Contacts	Defrost
Open	Not enabled
Closed	Enabled (defrost start is still determined by the control)
Close with active defrost	when the digital input is opened, the defrost is immediately stopped and the unit restarts normal operation (without performing the dripping or post-dripping phases). The LED starts flashing to indicate that the defrost request is pending, waiting for the next enabling signal (closing of the contact), when the defrost will be performed completely.

Tab. 4.d



**Note:** this function is useful to prevent defrosts on the units accessible by the public during opening times.

4 = Start defrost from external contact

**Application:** this feature is useful in case you need to perform synchronized defrost across multiple units or otherwise manually controlled by an external contact. To perform the defrosts, connect a cyclical, mechanical or electronic timer to the digital input. You can connect multiple units at the same timer and set different values for the parameter d5 (defrost delay from multifunction input) to avoid simultaneous defrosts.

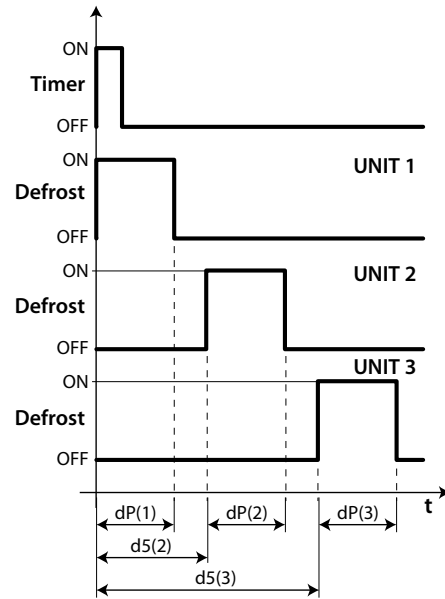


Fig. 4.m

Key

dP	Maximum defrost duration
UNIT 1...3	Unit 1...3
d5	Defrost delay from digital input
t	Time

5 = door switch (see parameter A3)

6=On/Off remote

The digital input can also be programmed as a remote ON/OFF switch. When the control is set to OFF:

- the temperature is displayed alternately with the message "OFF", the internal timer relative to the parameter dl is updated. If dl expires when the unit is OFF, a defrost is performed when the unit is switched on again;
- the auxiliary relays remain active set as an auxiliary output and light, the other auxiliary outputs are off;
- the buzzer and the alarm relay are off;
- the control does not perform the control functions, defrosts, continuous cycle, temperature alarm signalling and all the other functions;
- the compressor protection times are respected.

At control restart, all functions are reactivated, except:

- defrost at start-up;
- compressor and fan delay at start-up.



**Note:** The ON/OFF from external digital input has priority over the keypad and the supervisor.

7 = Change set point (r4-r5) from switch

The temperature and/or humidity set point can be changed by digital input, adding a temperature (r4) and/or humidity (r5) offset:

Digital input open	Digital input closed
Current set point (temperature) = St	Current set point (temperature) = St + r4
Current set point (humidity) = StH	Current set point (humidity) = StH + r5

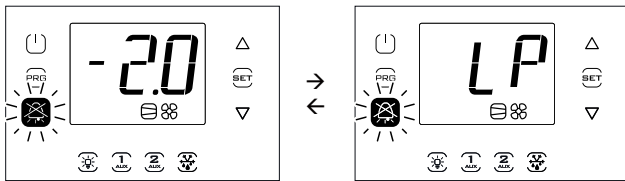
When the digital input (e.g. DI2 A5=7) is closed, the current set point (e.g. temperature) changes from St to St+r4 and the SET button on the display (or "Set point" on the pGD) starts flashing. When the same digital input is open, the set point returns to the initial value and the SET button stops flashing.

**8 = Low pressure switch**

By setting A5/A9=8 you can manage the low pressure switch. The low pressure alarm "LP" is signalled when the low pressure switch is triggered:

- during normal regulation, with active compressor and pump down function is disabled (c7=0)
- with pump-down function enabled (c7 >0), if the pump down valve is opened and the compressor is active.

The low pressure alarm signal is delayed by the time set for parameter A7. The low pressure alarm 'LP' stops the compressor.



**9, 10, 11 = Do not select**

**12 = Auxiliary output**

Setting H1/H5 = 2 the corresponding output AUX1/ AUX2 is activated by the key AUX1/ AUX2 or from DI if set. In addition, a digital input DI1, DI2 or DI3 (set A11, A5 or A9 = 12) can be used to control AUX1 or AUX2. In this case the key and the digital input have the same priority as regards the switch on.

**13 = Do not select**

**14 = Continuous cycle activation**

**Activation:** passage of the contact from opened to closed;  
**Deactivation:** passage of the contact from closed to opened.

**15 = Alarm from generic function**

Digital inputs DI2 and DI3 can be associated with special alarms, using the generic functions, and can be activated with the input open or closed (see the paragraph on Generic functions).

**16 = Start/stop defrost from external contact**

Application: an external device is used to start the defrost (on closing the digital input) and subsequently stop it (on opening the digital input). When the digital input opens, the dripping time set for parameter dd must then elapse.

**Note:**

- if following the start of the defrost, the digital input does not open before the time dP1 elapses, the defrost will terminate by time and alarm Ed1 will be displayed (defrost ended by timeout).
- opening of the digital input does not start the defrost only if the defrost probe (e.g. B2) temperature is greater than dt1 (end defrost temperature on main evaporator).
- if a separate defrost is configured on two evaporators (d13=1) and start/stop defrost from external contact is set, both evaporators are defrosted at the same time.

**17 = Serious alarm**

Application: external alarm that causes the immediate deactivation of the outputs on UltraCella (except those configured as a light/alarm) so as to prevent a dangerous situation. This can be used, for example, to stop the compressor following activation of the "Cold room occupied" alarm or to deactivate the heaters if an external protection device is activated.

When the alarm is activated:

- a signal is shown on the display ("SA");
- the buzzer is activated, if enabled
- the alarm relay is activated, if selected;

The following actions occur on the actuators:

- immediate deactivation of all the outputs (relays), except for those configured as lights and/or alarms.

**Note:**

- when shutting down the compressor, the minimum compressor on time (c3) and the running time relating to parameter A6 (stop compressor from external alarm) are ignored.
- if more than one digital input is configured as a serious alarm, the alarm is generated when just one of the inputs is open.

**4.6.6 Type of defrost**

UltraCella allows you to manage the following types of defrost, depending on parameter d0:

0. electric heater defrost by temperature;
1. hot gas defrost by temperature;
2. electric heater defrost by time;
3. hot gas defrost by time.

For further explanations please see chap. 6.

Par.	Description	Def	Min	Max	UoM
d0	Type of defrost	0	0	3	-
	0   heater by temperature.				
	1   hot gas by temperature				
	2   heater by time				
dt1	End of defrost temperature, main evaporator	4.0	-50.0	200.0	°C/°F
	3   hot gas by time				
dP1	Maximum defrost duration	30	1	250	min

**4.6.7 Evaporator Fans**

During the dripping periods (parameter dd > 0) and post-dripping periods (parameter Fd > 0) the evaporator fans are always off. This is useful to allow the evaporator to return to normal temperature after defrost. There is the possibility to force the start of the evaporator fans during control (parameter F2) and during defrost (parameter F3). See chap. 6

Par.	Description	Def	Min	Max	UoM
dd	Dripping time after defrost (fans off)	2	0	30	min
F2	Fan activation time with compressor OFF	30	0	60	-
F3	Evaporator fan during defrost	1	0	1	-
	0/1=on/off				
Fd	Post dripping time (fans off)	1	0	30	min

**4.6.8 Door opening**

If the door is left open, the signalling control is made via the door switch (if A3=1, digital input DI1, already configured as the door switch, is disabled). When the door is open, the evaporator fans are turned off if configured at fixed speed (F0=0,1), otherwise operate at minimum speed defined by parameter F7 (if F7<50) if set as variable speed fans (F0= 2); the compressor continues to operate for the time c12, then turns off. Once passed the period of time d8d from door opening, compressor and evaporator fans are running again and the error "dor" is displayed.

Par.	Description	Def	Min	Max	UoM
c12	Compressor safety time, door switch	5	0	5	min
	0 = disabled door management				
d8d	Compressor restart time for door switch	30	c12	240	min

Special cases refer figure 4.n and 4.o:

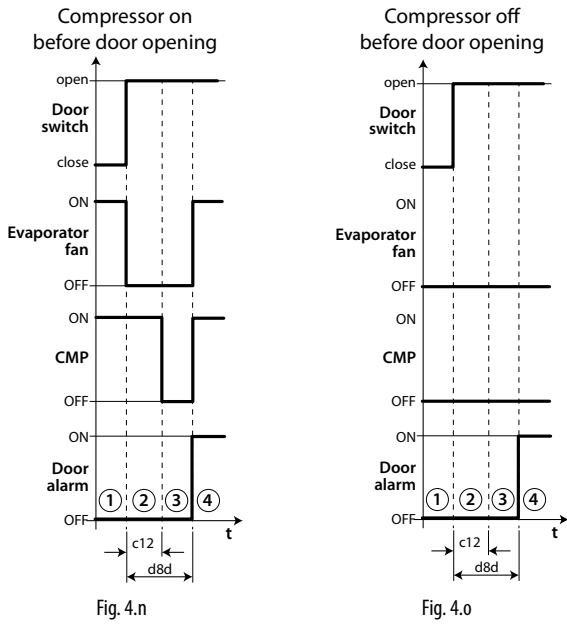
- to disable door alarm, set d8d = 0. If d8d = 0, c12 is also considered =0;
- to keep only phase 2 (figure), in which the compressor is on, and to eliminate phase 3 in which the compressor/ evaporator fan is off, set d8d=c12;
- to keep only phase 3 (figure), c12=0;
- during phase 3 the compressor may be on if:
  1. pump down is activated;
  2. hot gas defrost is activated.



**Note:** If the door switch digital input DI1 is disabled (A3=1):

- Parameters C12 and d8d have no meaning, as the controller cannot know whether the door is open or closed

- The door open icon will always be off



### 4.7 Light management

The light can be managed:

- from door switch (if A3=0) and/or light key;
- only from light key.

Below are indicated the involved parameters.

Par.	Description	Def	Min	Max	UoM
tLi	Light on with door open	120	0	240	min
A4	Light management	0	0	1	-
	0   Door switch + light key				
	1   Light key				

**Note:** if the control is OFF, the light output is controlled only by the light key. If the control is set to ON, the light is controlled by a door switch + light key or just light key according to the setting of the parameter A4.

#### 4.7.1 Door switch + light key

If A4=1 the light is on/off only using the light key. The open/closed status of the door is ignored. If A4=0, when the cold room door is opened, the light is always on. When the door is closed, the light can be turned on or off using the light key. Once turned on, the light will automatically turn off after the time set in parameter tLi.

#### LIGHT CONTROL FROM DOOR SWITCH AND LIGHT KEY

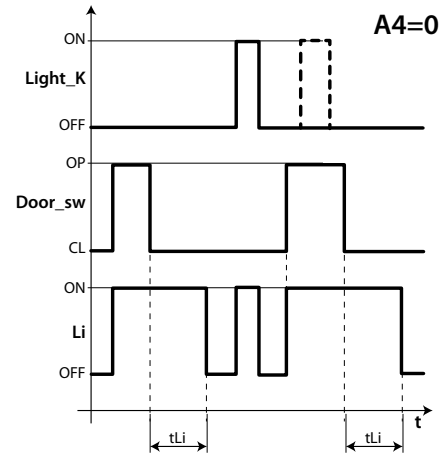


Fig. 4.q

Key

Light_k	Light key
Li	Light
Door_sw	Door switch
tLi	Light turn off delay
t	Time

### 4.8 Other configuration parameters

The configuration parameters must be set during the commissioning of the controller and concern:

- date/time set;
- measurement stability of the analogue probes;
- display of the decimal point on control;
- serial address for monitoring network connection;
- the type of protocol on the BMS serial port for connection to the supervisor network
- temperature (°C / °F) and pressure (bar/psi) measurement unit
- disabling of keyboard, keys and buzzer;
- display view during defrost.

#### Date/ time set

See example 2 in chap.3.

Key

	Time
Door_sw	door switch
Evap_fan	Evaporator fan
CMP	Compressor
Dor alarm	Door alarm "dor"

**Note:** to render the time settings operational, the control must restart. Otherwise, the settings will be used only at the next use, when the inner timers are set.

### 4.6.9 Compressor management

- c1 determines the minimum time between two consecutive starts of the compressor;
- c2 sets the minimum turn off time for the compressor.
- c3 sets the minimum running time for the compressor.

Par.	Description	Def	Min	Max	UoM
c1	Minimum time between two successive starts of the compressor	6	0	30	min
c2	Compressor minimum switch-off time	3	0	15	min
c3	Compressor minimum switch-on time	3	0	15	min

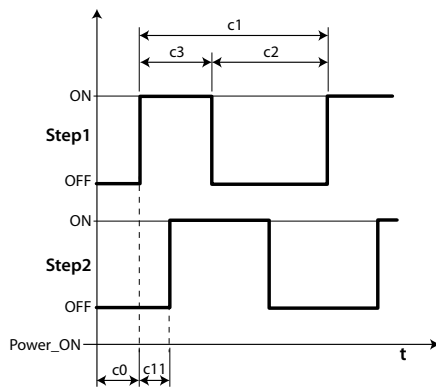


Fig. 4.p

**Note:** c2 parameter used to ensure the balance of the pressure after the compressor stop and to avoid blocking at the next reboot of those compressors that do not have sufficient starting torque.

**Analogue probes measuring stability**

It defines the filter coefficient used to stabilize the temperature measurement. Low values assigned to this parameter allow a prompt response of the sensor to temperature variations, but the reading becomes more sensitive to disturbance. High values slow down the response, but guarantee greater immunity to disturbance, that is, a more stable and more precise reading.

Par.	Description	Def	Min	Max	UoM
/21	Stability measuring probe 1	4	0	9	-
/22	Stability measuring probe 2	4	0	9	-
/23	Stability measuring probe 3	4	0	9	-
/24	Stability measuring probe 4	4	0	9	-
/25	Stability measuring probe 5	4	0	9	-

**Display view**

On models with single row display, P/Ns WB000S\*, it is possible to show a single characteristic, selectable through /t1 parameter.

On models with two rows, P/Ns WB000D\*, and on the UltraCella Service terminal, it is possible to show two different characteristics, the first selectable through /t1 parameter, and the second through /t2 parameter.

Par.	Description	Def	Min	Max	UoM	
/t1	Display variable 1	1	0	13	-	
	0 None					9 B3
	1 Virtual probe					10 B4
	2 Outlet probe					11 B5
	3 Intake probe					12 Sc
	4 Defrost probe 1					13 Variable speed condenser fans set point
	5 Defrost probe 2					
	6 Temp. set point					14 Humid. set point
	7 B1					
8 B2						
/t2	Display variable 2	6	0	23	-	
	0 None					12 rd
	1 Virtual probe					13 superheat (EVD EVO)
	2 Outlet probe					14 valve opening % (EVD EVO)
	3 Intake probe					15 valve opening step (EVD EVO)
	4 Defrost probe 1					16 Sc
	5 Defrost probe 2					17 Sd1 (3PH mod.)
	6 Set point					18 Sd2 (3PH mod.)
	7 B1					19 Sc (3PH mod.)
	8 B2					20 Variable speed condenser fans set point
	9 B3					21 Superheat (EVDice)
	10 B4					22 Valve opening % (EVDice)
11 B5	23 Step valve opening (EVDice)					

**Serial address (parameter H0)**

H0 assigns an address to check for serial connection to a supervision system and / or remote assistance.

Par.	Description	Def	Min	Max	UoM
H0	Serial Address	193	0	247	-

Starting from software release 1.5, both CAREL and Modbus protocols are available on the BMS serial port, selected by parameter H7.

 **Note:** H0 maximum value is 207 for CAREL protocol and 247 for Modbus protocol.

Par.	Description	Def	Min	Max	UoM
H7	BMS serial protocol 0= CAREL protocol 1= Modbus protocol	0	0	1	-

Starting from software release 1.7, the baud rate, stop bits and parity of the BMS port can be set using parameters H10, H11 and H12; the data bits setting on the other hand remains fixed at 8.

Par.	Description	Def	Min	Max	UoM			
H10	BMS baud rate bit/s	4	0	9	-			
	0					1200	5	38400
	1					2400	6	57600
	2					4800	7	76800
	3					9600	8	115200
H11	BMS stop bits	2	1	2	-			
	1					1 stop bit		
	2					2 stop bits		
H12	BMS parity	0	0	2	-			
	1					odd		
	2					even		

 **Note:** to make the changes active, switch the unit off and on again.

**Temperature unit of measure and decimal point display**

The control allows:

- choosing the temperature measuring unit between Celsius (°C) and Fahrenheit (°F) degrees;
- to enable/disable the display of the decimal point and buzzer.

Par.	Description	Def	Min	Max	UoM
/5t	Temperature unit of measure 0/1 = °C / °F	0	0	1	-
/SP	Pressure unit of measure 0/1 = bar / psi	0	0	1	-
/6	Display decimal point 0/1 = yes/no	0	0	1	-
H4	Buzzer 0/1 = enabled/disabled	0	0	1	-

**Disable keypad**

You can inhibit some functions relating to the use of the keypad, for example, the modification of the parameters and the set point if the unit is accessible to the public

Par.	Description	Def	Min	Max	UoM
H6	Terminal keys block configuration 0 = all keys enabled. 255 = all keys disabled	0	0	255	-

**Configuration table**

FUNCTION	par. H6
Set-point modification	1
Defrost	2
-	4
AUX1 output	8
PRG+SET (menu)	16
AUX2 output	32
On/Off management	64
Light management	128

Tab. 4.e

**Example:** to disable the activation functions of the outputs AUX1 and AUX2, set H6 = 8+32 = 40.



### 4.9 Ultra EVD EVO module commissioning

WM00ENNI00, WM00EUN000, WM00EUK000: Connect UltraCella to the EVD module via serial, as shown in the wiring diagram in Figure 2.k, and refer to the following parameter table for configuration of the EVD EVO driver. The module will become active when enabled by UltraCella, setting P1=1.

Par.	Description	Def	Min	Max	UoM
P1	Enable communication with EVD EVO module 1 = EVD EVO module enabled	0	0	1	-

WM00ENSI00, WM00ENS000, WM00EUS000, WM00EUC000:

#### 1. Using the EVD EVO display to configure the driver

Connect an auxiliary output on UltraCella (AUX1 or AUX2) electrically to digital input DI1 on the EVD EVO and set the parameters as follows:

- H1=7 (for AUX1) or H5=7 (for AUX2) -> delayed second compressor
- C11=0 -> second compressor activation delay = 0

Par.	Description	Def	Min	Max	UoM
H1	AUX1 output configuration 7 = Delayed compressor	1	0	17	-
H5	AUX2 output configuration 7 = Delayed compressor	1	0	17	-
C11	Second compressor start delay 0 = instant start with main compressor output	4	0	250	sec

In this way, the auxiliary output will be configured as a voltage-free contact to control the compressor, suitable to be connected to digital input DI1 on the EVD EVO driver. No configuration is required on UltraCella.

#### 2. Configuring the EVD EVO driver from UltraCella

Connect UltraCella to the EVD EVO module via serial, as shown in the wiring diagram in Figure 2.k, and refer to the following parameter table for configuration of the EVD EVO driver. The module will become active when enabled by UltraCella, setting P1=1.

If connected via serial, the driver parameters can only be displayed (not modified) on the EVD EVO local display. Once the driver has been enabled (parameter P1=1), its parameter settings will be sent by UltraCella, in accordance with the parameter table below (only modifiable from UltraCella); any parameters previously configured on the EVD EVO display will be overwritten.

Par.	Description	Def	Min	Max	UoM
P1	Enable communication with EVD EVO module 1 = EVD EVO module enabled	1	0	1	-

#### EVD EVO parameter table

The following parameters corresponding to the EVD EVO driver can be configured from UltraCella.

Category: EVO

Par.	Description	Def	Min	Max	UoM
P1	Enable communication with EVD EVO module 0/1=disabled/enabled	0	0	1	-
P1t	S1 probe type 0 RAZ. 0-5V      2 4 to 20mA REMOTE 1 4 to 20mA      3 4 to 20mA EXTERNAL	0	0	3	-
P1M	Max value of S1 probe	12,8	-20	200	bar/psi
P1n	Min value of S1 probe	-1	-20	200	Bar/psi

PVt	Valve type	1	1	22	-
	1 Carel exv      12 Sporlan seh 100				
	2 Alco ex4      13 Sporlan seh 175				
	3 Alco ex5      14 Danfoss ets 12.5 - 25b				
	4 Alco ex6      15 Danfoss ets 50b				
	5 Alco ex7      16 Danfoss ets 100b				
	6 Alco ex8 330hz CAREL recommended      17 Danfoss ets 250				
	7 Alco ex8 500hz alco specification      18 Danfoss ets 400				
	8 Sporlan sei 0.5-11      19 two CAREL exv connected together				
	9 Sporlan ser 1.5-20      20 Sporlan ser(i) g, j, k				
	10 Sporlan sei 30      21 Danfoss ccm 10-20-30				
	11 Sporlan sei 50      22 Danfoss ccm 40				
PH	Refrigerant type	3	1	25	-
	1 R22      15 R422D      29 R455A				
	2 R134a      16 R413A      30 R170				
	3 R404A      17 R422A      31 R442A				
	4 R407C      18 R423A      32 R447A				
	5 R410A      19 R407A      33 R448A				
	6 R507A      20 R427A      34 R449A				
	7 R290      21 R245FA      35 R450A				
	8 R600      22 R407F      36 R452A				
	9 R600A      23 R32      37 R508B				
	10 R717      24 HTR01      38 R452B				
	11 R744      25 HTR02      39 R513A				
	12 R728      26 R23      40 R454B				
	13 R1270      27 R1234yf				
	14 R417A      28 R1234ze				
PrE	Main regulation type	2	1	4	-
	1 centralized cabinet cold room				
	2 self contained cabinet cold room				
	3 perturbed cabinet cold room				
	4 subcritical CO2 cabinet/cold room				
P0	EVD Modbus address	198	1	247	-
P3	Superheat setpoint	10	-72	324	K
P4	Proportional gain	15	0	800	-
P5	Integral time	150	0	999	sec
P6	Derivative time	2	0	800	sec
P7	LowSH: threshold low superheat	3	-72	324	K
P8	Low Superheat protection integral time	600	0	800	sec
P9	LowSH: low superheat alarm delay	600	0	999	sec
PL1	LOP: threshold for low temp. of evapor.	-50	-60	200	°C/°F
PL2	LOP: integral time	600	0	800	sec
PL3	LOP: low evaporation temperature alarm delay	600	0	999	sec
cP1	Open valve startup, Percentage	50	0	100	%
PM1	MOP: max evap. pressure threshold	50	-60	200	°C/°F
PM2	MOP: integral time	600	0	800	sec
PM3	MOP: max evap. pressure alarm delay	10	0	999	sec
Pdd	Post defrost delay, only for single driver	10	0	60	min
PSb	Valve position in stand-by	0	0	100	step
PMP	Enable manual positioning	0	0	1	-
PMu	Manual valve positioning	0	0	999	step
Pnr	Reset EVD setting 0 -> 1 Reset all EVD EVO parameters	0	0	1	-
PLt	Stop smooth lines offset	2.0	0.0	10.0	°C/°F
PHS	Maximum smooth lines offset	15.0	0.0	50.0	°C/°F
PSP	Smooth lines proportional coefficient	5.0	0.0	100.0	°C/°F
PSI	Smooth lines integral time	120	0	1200	s
PSd	Smooth lines derivative time	0	0	100	s
PSM	Enable smooth lines (0=NO - 1=YES)	0	0	1	/

### 4.10 EVDice commissioning

Connect UltraCella to the EVDice driver via the serial line according to the wiring diagram shown in Figure 2.o, and refer to the parameter table 4.e below for configuration of the EVDice driver.

UltraCella software release 1.7 features new EVDice driver management functions:


- Possibility to configure the EVDice parameters on the UltraCella user interface (built-in LED display or UltraCella Service terminal) and/or on the local EVDice LED display user interface.
- EVDice custom configuration protection by signature: as soon as communication is established, UltraCella "signs" EVDice by writing a random number between 1 and 65000 to a register on the driver. This allows unique identification of:
  - EVDice drivers that have been previously configured
  - "new" EVDice drivers (e.g. replaced due to a fault)

There are three possible cases:

**New installation / New system / EVDice installed following installation:**  
 in this case, the signature on UltraCella will initially be 0 -> the active parameters will be those set on EVDice, and UltraCella will generate a new signature. Proceed as follows:

1. Confirm that the EVDice is present by setting IPE=1 (communication with EVDice enabled), or by answering "yes" to a specific question in the wizard on the UltraCella Service terminal; UltraCella will sign the EVDice so as to create the controller-driver combination;
2. The IEC (EVDice configuration error) alarm will be activated and the controller (and the compressor) will stop (UltraCella forces parameter ICG=0, EVDice not enabled for control). Configure the EVDice parameters based on the application, either using the wizard, or parameter-by-parameter on the LED display interface;
3. Once all of the required EVDice parameters have been configured, set ICG=1 to activate control. Setting ICG=1 also resets the IEC alarm.


**Replacing EVDice due to a fault / other causes:**


1. UltraCella will have a signature other than 0 (as it has been previously configured to manage an EVDice driver), while the EVDice will have a different signature from the one saved on UltraCella (either 0 if new, or a number other than 0 if originating from another installation). In this case, the initially active parameters will be those set on UltraCella (the parameters on UltraCella corresponding to the EVDice driver will be copied to the EVDice). Proceed as follows:
  - The IEM alarm (EVDice error mismatch) is active to warn the user that an element in the system has been changed. If necessary, modify the EVDice parameters based on the application, either using the wizard, or parameter-by-parameter on the LED display interface;
  - The controller is will active even when the IEM alarm is active; to disable the alarm, press  on the UltraCella LED display.
2. The signature on UltraCella will be equal to 0 (as it is new or has not been previously configured to communicate with an EVDice driver), while EVDice will have a signature (signature other than 0). In this case, the initially active parameters will be those set on EVDice (the parameters corresponding to the EVDice driver will be copied to UltraCella). The case is identical to a new installation / new system:
  - Confirm that the EVDice is present by setting IPE=1 (communication with EVDice enabled), or by answering "yes" to a specific question in the wizard on the UltraCella Service terminal; UltraCella will sign the EVDice so as to create the controller-driver combination;
  - The IEC (EVDice configuration error) alarm will be activated and the controller (and the compressor) will stop (UltraCella forces parameter ICG=0, EVDice not enabled for control). Configure the EVDice parameters based on the application, either using the wizard, or parameter-by-parameter on the LED display interface;
  - Once all of the required EVDice parameters have been configured, set ICG=1 to activate control. Setting ICG=1 also resets the IEC alarm.


**Replacing UltraCella due to a fault / other causes:**


The signature on UltraCella will be equal to 0 (as it is new or has not been previously configured to communicate with an EVDice driver), while EVDice will have a signature (signature other than 0). In this case, the initially active parameters will be those set on EVDice (the parameters corresponding to the EVDice driver will be copied to UltraCella). The case is identical to a new installation / new system.

Par.	Description	Def	Min	Max	UoM
IPE	Enable EVDice communication 0/1 = disabled / enabled	0	0	1	-
ICG	Enable EVDice control 0/1 = disabled / enabled	0	0	1	-

 **Note:** when IPE=0 (communication with EVDice disabled), the only parameters visible on the UltraCella built-in LED display are: IPE, IrE (EVDice operating mode), IP3 (superheat set point), PH (type of refrigerant) and In1 (EVDice serial address from UltraCella)

 **Note:** the signature on EVDice can be set to zero using the reset procedure on the built-in LED interface (see EVDice manual +0300037EN)

 **Note:** the above are valid for EVDice firmware release 1.4; UltraCella software release 1.7 in any case maintains compatibility with EVDice drivers featuring previous firmware releases. In particular, the IEC and IEM alarms will be always disabled, parameters IPE and ICG will have always the same value and UltraCella will not generate any signature

 **Note:** in UltraCella software release 1.7, the EVDice firmware release is read-only when parameter IPE=1 (communication with EVDice enabled)


**EVD ICE parameter table**

The following parameters correspond to the EVD ICE driver, and are configured on UltraCella.



Category: ICE

Parameter name on EVD ICE	Description	Def	Min	Max	UoM	Type	Parameter name on UltraCella (LED display)	Present on UltraCella Service pGD	Present in wizard (UltraCella Service pGD)																																																																																				
-	Enable EVD ICE /1 = not enabled/ enabled	0	0	1	-	Advanced	IPE	✓	✓																																																																																				
Operating mode	1=Multiplexed cabinet/cold room 2=Air-conditioner/chiller with plate heat exchanger 3=Air-conditioner/chiller with tube bundle heat exchanger 4=Air-conditioner/chiller with finned coil heat exchanger 5=Reserved 6=Reserved	1	1	6 (modes 2, 3, 4, 5 and 6 can only be selected on UltraCella service pGD)	-	Initial configuration	IrE	✓	✓																																																																																				
Superheat	Superheat set point	11	C1	99	K	Initial configuration	IP3	✓	✓																																																																																				
Type of gas	<table border="1"> <tr><td>1</td><td>R22</td><td>15</td><td>R422D</td><td>29</td><td>R455A</td></tr> <tr><td>2</td><td>R134a</td><td>16</td><td>R413A</td><td>30</td><td>R170</td></tr> <tr><td>3</td><td>R404A</td><td>17</td><td>R422A</td><td>31</td><td>R442A</td></tr> <tr><td>4</td><td>R407C</td><td>18</td><td>R423A</td><td>32</td><td>R447A</td></tr> <tr><td>5</td><td>R410A</td><td>19</td><td>R407A</td><td>33</td><td>R448A</td></tr> <tr><td>6</td><td>R507A</td><td>20</td><td>R427A</td><td>34</td><td>R449A</td></tr> <tr><td>7</td><td>R290</td><td>21</td><td>R245FA</td><td>35</td><td>R450A</td></tr> <tr><td>8</td><td>R600</td><td>22</td><td>R407F</td><td>36</td><td>R452A</td></tr> <tr><td>9</td><td>R600A</td><td>23</td><td>R32</td><td>37</td><td>R508B</td></tr> <tr><td>10</td><td>R717</td><td>24</td><td>HTR01</td><td>38</td><td>R452B</td></tr> <tr><td>11</td><td>R744</td><td>25</td><td>HTR02</td><td>39</td><td>R513A</td></tr> <tr><td>12</td><td>R728</td><td>26</td><td>R23</td><td>40</td><td>R454B</td></tr> <tr><td>13</td><td>R1270</td><td>27</td><td>R1234yf</td><td></td><td></td></tr> <tr><td>14</td><td>R417A</td><td>28</td><td>R1234ze</td><td></td><td></td></tr> </table>	1	R22	15	R422D	29	R455A	2	R134a	16	R413A	30	R170	3	R404A	17	R422A	31	R442A	4	R407C	18	R423A	32	R447A	5	R410A	19	R407A	33	R448A	6	R507A	20	R427A	34	R449A	7	R290	21	R245FA	35	R450A	8	R600	22	R407F	36	R452A	9	R600A	23	R32	37	R508B	10	R717	24	HTR01	38	R452B	11	R744	25	HTR02	39	R513A	12	R728	26	R23	40	R454B	13	R1270	27	R1234yf			14	R417A	28	R1234ze			3	1	40	-	Initial configuration	IPH	✓	✓
1	R22	15	R422D	29	R455A																																																																																								
2	R134a	16	R413A	30	R170																																																																																								
3	R404A	17	R422A	31	R442A																																																																																								
4	R407C	18	R423A	32	R447A																																																																																								
5	R410A	19	R407A	33	R448A																																																																																								
6	R507A	20	R427A	34	R449A																																																																																								
7	R290	21	R245FA	35	R450A																																																																																								
8	R600	22	R407F	36	R452A																																																																																								
9	R600A	23	R32	37	R508B																																																																																								
10	R717	24	HTR01	38	R452B																																																																																								
11	R744	25	HTR02	39	R513A																																																																																								
12	R728	26	R23	40	R454B																																																																																								
13	R1270	27	R1234yf																																																																																										
14	R417A	28	R1234ze																																																																																										
S1	Type of probe S1 1=-1 to 4.2 barg 2=0.4 to 9.3 barg 3=-1 to 9.3 barg 4=0 to 17.3 barg 5=0.85 to 34.2 barg 6=0 to 34.5 barg 7=0 to 45 barg 8=-1 to 12.8 barg 9=0 to 20.7 barg 10=1.86 to 43.0 barg 11 = Reserved	3	1	11	-	Advanced	IS1	✓	✓																																																																																				
CP	PID: proportional gain	15	0	800	-	Advanced	ICP	✓	-																																																																																				
ti	PID: integral time	150	0	999	sec	Advanced	Iti	✓	-																																																																																				
C1	LowSH protection: threshold	5	-9	IP3	°C/°F	Advanced	IC1	✓	-																																																																																				
C2	LowSH protection: integral time	15	0	800	sec	Advanced	IC2	✓	-																																																																																				
C3	LOP protection: threshold	-50	-121	C5	°C/°F	Advanced	IC3	✓	-																																																																																				
C4	LOP protection: integral time	0	0	800	sec	Advanced	IC4	✓	-																																																																																				
C5	MOP protection: threshold	50	C3	392	°C/°F	Advanced	IC5	✓	-																																																																																				
C6	MOP protection: integral time	20	0	800	sec	Advanced	IC6	✓	-																																																																																				
C7	MOP protection: disable threshold	30	-121	200	°C/°F	Advanced	IC7	✓	-																																																																																				
C8	Low suction temperature alarm threshold	-121	-392	200	°C/°F	Advanced	IC8	✓	-																																																																																				
IA	Enable operating mode modification 0/1 = enabled/not enabled	0	0	1	-	Advanced	IIA	✓	-																																																																																				
U1	Enable manual valve positioning 0/1 = enabled/not enabled	0	0	1	-	Advanced	IU1	✓	-																																																																																				
U2	Manual valve position	0	0	999	step	Advanced	IU2	✓	-																																																																																				
U3	Valve control steps: 1/2 = 480/960 step	1	1	2	-	Advanced	IU3	✓	✓																																																																																				
U4	Valve opening at start (evaporator/valve capacity ratio)	50	0	100	%	Advanced	IU4	✓	-																																																																																				
n1	Serial address	99	1	99	-	Advanced	In1	✓	✓																																																																																				
-	Enable EVD ICE regulation 0/1 = not enabled/ enabled	0	0	1	-	Advanced	ICG	✓	✓																																																																																				

 **Note:** as EVD ICE has a two digit display, when its parameters are displayed on UltraCella, the letter "I" has been added to every parameter code: e.g. S1 -> IS1

 **Note:** all EVD ICE parameters are visible both on the LED user interface and on the UltraCella Service terminal (pGD).

### 4.11 Ultra 3Ph Evaporator module commissioning

Ultra 3PH Evaporator module has to be configured by UltraCella.

- Please make sure that, inside Ultra 3PH Evaporator module, dip-switches of I/O expansion are set as per following figure (default setting):

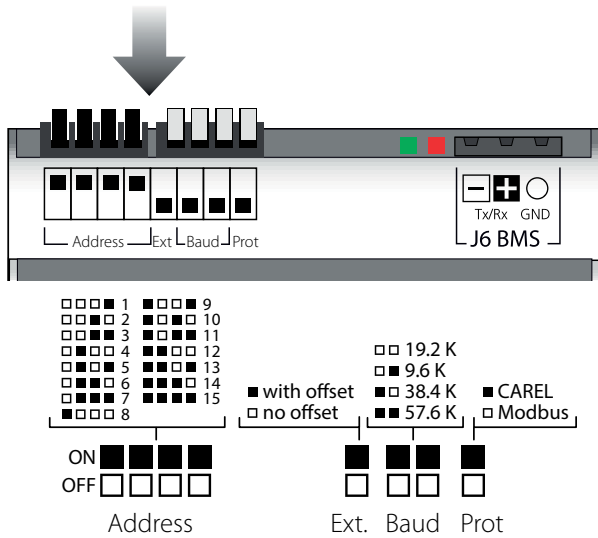


Fig. 4.r

which corresponds to following configuration:

- Address = 15
  - No offset
  - Baudrate = 19200bit/sec
  - Protocol = Modbus
- In UltraCella, access to parameter category "3PH"
  - Make sure that first two parameters are set as follows (Carel default setting):
    - cH1 = 15 (Address)
    - cH2 = 0 (Offset)
  - For 3PH Evaporator module, set (Carel default setting)
    - cH3 = 0
  - If defrost probe and auxiliary evaporator defrost probe have to be connected to Ultra 3PH Evaporator module, set:
    - cA1 = 1
    - cA2 = 1
 For Ultra 3PH Evaporator module, don't consider parameter cA3
  - Enable 3PH Evaporator module by setting:
    - cEn = 1

**Note:** to ensure the communication between UltraCella and the expansion module, the I/O expansion network address and parameter cH1 on UltraCella must be set to the same value (default 15).

**Important:** This setting of the dipswitches on the I/O expansion (corresponding to serial address 15) is active starting from November 2015 and guarantees "plug & play" communication with UltraCella controllers running software release 1.7 (default value cH1=15). Expansion modules manufactured prior to November 2015 have the default address setting as 1 (different dipswitch configuration than shown in the figure). UltraCella controllers running a software release lower than 1.7 are set with cH1=1 by default. In some cases, then, the two configurations will need to be aligned manually.

### 4.11.2 Parameters (UltraCella)

UltraCella has a subset of parameters dedicated to Ultra 3PH Evaporator module configuration.

Category: 3PH

Par	Description	Def	Min	Max	UOM
cH1	3PH module serial address	15	1	247	-
cH2	3PH module offset serial address	0	0	232	-
cH3	Type of three phase module 0 = Evaporator 1 = Full	0	0	1	-
cA1	Sd1 probe connection 0 = in UltraCella 1 = in 3PH module	0	0	1	-
cA2	Sd2 probe connection 0 = in UltraCella 1 = in 3PH module	0	0	1	-
cA3	Sc probe connection (Full module only) 0 = in UltraCella 1 = in 3PH module	0	0	1	-
cEn	Enable 3PH mod. 0 = disable 1 = enable	0	0	1	-

### 4.11.3 Function

Ultra 3PH Evaporator Module has to be combined with UltraCella controls (P/Ns WB000S% or WB000D%). Module has inside high power actuators to handle directly three-phase loads of the evaporator, but logic and regulation algorithms are inside UltraCella.

In the table below details of where probes and loads can be connected.



**Note:**

- Although three-phase loads have to be physically connected to Ultra 3PH Evaporator module, UltraCella maintains its standard configuration of relays.

Input	Connected	
	UltraCella	Ultra 3PH Evaporator module
Ambient probe	✓	-
Defrost probe Sd1	✓	cA1 = 0
	-	cA1 = 1
Defrost probe auxiliary evaporator Sd2	✓	cA2 = 0
	-	cA2 = 1
	-	✓

Output	UltraCella	Ultra 3PH Evaporator module
Compressor command / Condensing unit enabling / Solenoid valve	✓ (1PH)	✓ (1PH)
Defrost heaters	✓ (1PH)	✓ (3PH)
Evaporator fans	✓ (1PH)	✓ (3PH)
Light	✓ (1PH)	-
AUX1	✓ (1PH)	✓ (1PH)
AUX2	✓ (1PH)	-

Tab. 4.f

## 4.12 Ultra 3Ph Full module commissioning

Ultra 3PH Full module has to be configured by UltraCella.

- Please make sure that, inside Ultra 3PH Full module, dip-switches of I/O expansion are set as per following figure (default setting):

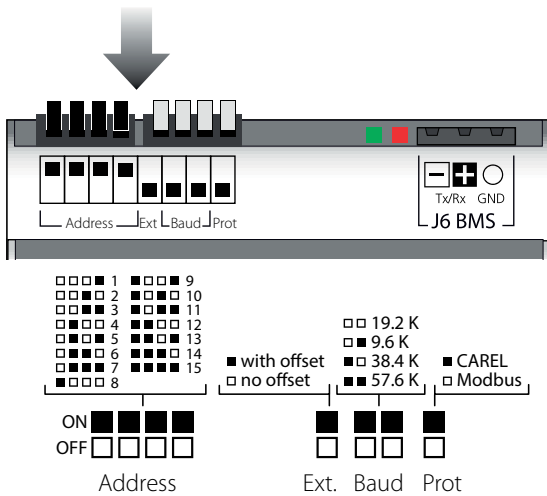


Fig. 4.s

which corresponds to following configuration:

- Address = 15
  - No offset
  - Baudrate = 19200bit/sec
  - Protocol = Modbus
- In UltraCella, access to parameter category “3PH”
  - Make sure that first two parameters are set as follows (Carel default setting):
    - cH1 = 15 (Address)
    - cH2 = 0 (Offset)
  - For 3PH Full expansion module, set
    - cH3 = 1
  - If defrost probe and auxiliary evaporator defrost probe have to be connected to Ultra 3PH Full module, set:
    - cA1 = 1
    - cA2 = 1
  - If condenser probe has to be connected to Ultra 3PH Full module, set:
    - cA3 = 1
  - Enable 3PH Full module by setting:
    - cEn = 1

**Note:** to ensure the communication between UltraCella and the expansion module, the I/O expansion network address and parameter cH1 on UltraCella must be set to the same value (default 15).

**Important:** this setting of the dipswitches on the I/O expansion (corresponding to serial address 15) is active starting from November 2015 and guarantees “plug & play” communication with UltraCella controllers running software release 1.7 (default value cH1=15). Expansion modules manufactured prior to November 2015 have the default address setting as 1 (different dipswitch configuration than shown in the figure). UltraCella controllers running a software release lower than 1.7 are set with cH1=1 by default. In some cases, then, the two configurations will need to be aligned manually.

### 4.12.1 Parameters (UltraCella)

UltraCella ha un sottoinsieme di parametri dedicati alla configurazione del modulo Ultra 3PH Full.

Par	Description	Def	Min	Max	UoM
cH1	3PH module serial address	15	1	247	-
cH2	3PH module offset serial address	0	0	232	-
cH3	Type of three phase module 0 = Evaporator 1 = Full	0	0	1	-
cA1	Sd1 probe connection 0 = in UltraCella 1 = in 3PH module	0	0	1	-
cA2	Sd2 probe connection 0 = in UltraCella 1 = in 3PH module	0	0	1	-
cA3	Sc probe connection (Full module only) 0 = in UltraCella 1 = in 3PH module	0	0	1	-
cEn	Enable 3PH mod. 0 = disable 1 = enable	0	0	1	-

### 4.12.2 Function

Ultra 3PH Full Module has to be combined with UltraCella controls (P/Ns WB0005% or WB000D%). Module has inside high power actuators to handle directly three-phase loads of the condensing and evaporator units, but logic and regulation algorithms are inside UltraCella. In the table below details of where probes and loads can be connected.

**Nota:**

- Although three-phase loads have to be physically connected to Ultra 3PH Full module, UltraCella maintains its standard configuration of relays.

Input	Connected	
	UltraCella	Ultra 3PH Full module
Ambient probe	✓	-
Defrost probe Sd1	✓	-
	-	✓
Defrost probe auxiliary evaporator Sd2	✓	-
	-	✓
Condensing probe Sc	✓	-
	-	✓

Uscita	UltraCella	Ultra 3PH Full module
Compressor command	✓ (1PH)	✓ (3PH)
Defrost heaters	✓ (1PH)	✓ (3PH)
Evaporator fans	✓ (1PH)	✓ (3PH)
Light	✓ (1PH)	-
AUX1	✓ (1PH)	✓ (1PH)
AUX2	✓ (1PH)	-

Tab. 4.g

## 5. OUTPUTS CONFIGURATION AND PROTECTIONS

### 5.1 Analogue output

It is available analog output Y1, to drive the evaporator fans designed to be operated with input 0 ... 10 V. See the chapter 6.9.


Par.	Description	Def	Min	Max	UoM
H01	Configuration output Y1	0	0	3	-
	0 Not active				
	1 Modulating output (generic function)				
	2 Variable speed evaporator fans set on Sd probe				
3 Variable speed condenser fans					

### 5.2 Digital Outputs

#### 5.2.1 Delay start for compressor output

Par.	Description	Def	Min	Max	UoM
c0	Compressor/ fan start delay at power on	0	0	15	min

- c0: from the moment in which the control is powered-up, turning on the compressor and the evaporator fan is delayed by a time (in minutes) equal to the value assigned to this parameter. This delay helps to protect the compressor against repeated starts in the case of frequent power failures.

 **Note:** for the other protection parameters (c1, c2, c3) see chapter 4.

#### 5.2.2 Safety devices for outputs with different relays

Par.	Description	Def	Min	Max	UoM
c11	Second compressor start delay	4	0	250	s

- c11 sets the activation delay between the first and the second compressor (or between the first and the second step of the compressor).

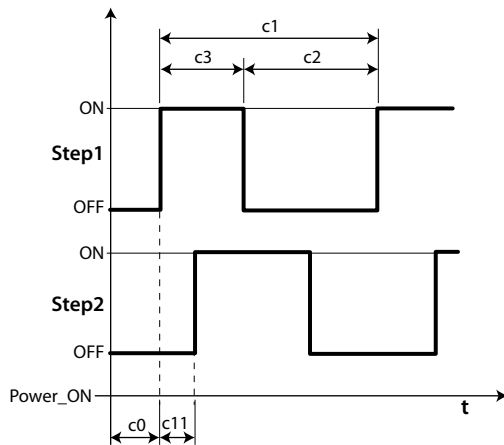


Fig. 5.a

**Key**

Step1	Step 1 compressor
Step2	Step 2 compressor
t	Time

#### 5.2.3 Output operation AUX1/AUX2

The AUX1 and AUX2 outputs can be associated with different functions, such as alarm, auxiliary output controlled by AUX button, the pump down valve, condenser fan, compressor, second compressor with rotation. For further explanations, please consult chapter 3.2.

Par.	Description	Def	Min	Max	UoM
H1	AUX1 output configuration	1	0	21	-
	0 Normally energised alarm				
	1 Normally de-energised alarm				
	2 Activate from AUX button or DI				
	3 Activate collection pan heater				
	4 Auxiliary evaporator defrost				
	5 Pump down valve				
	6 Condenser fan				
	7 Delayed compressor				
	8 Control output 1 ON/OFF				
	9 Control output 2 ON/OFF				
	10 Alarm output 1				
	11 Alarm output 2				
	12 Do not select				
	13 Second compressor step				
	14 Second compressor step with rotation				
	15 Humidity output				
	16 Reverse mode output				
	17 Output managed by time band				
	18 Control output 3 ON/OFF				
	19 Reverse output - dehumidification				
20 External dehumidifier					
21 Reverse mode output 2					
H5	AUX2 output configuration	1	0	17	-
	See H1				

## 6. CONTROL

### 6.1 Switching the controller ON and OFF

The state of ON/OFF can be controlled by more than one source, keyboard, digital input and supervisor. When the controller is off, the display will show the temperature selected for parameter /t1 alternating with the OFF message. The digital input can be used to switch the controller on/off, setting parameter A5/A9 to "6". The activation state of ON / OFF from digital input has priority over the one from the supervisor and keyboard.

Origin	Priority	Notes
Digital input	1	Disable On/Off from keypad and supervisor
Keyboard	2	
Supervisor	3	

Tab. 6.a

### 6.2 Virtual probe

The control output of the controller is the compressor output. The control probe is the ambient probe B1 (default setting), while the probes B2, B3, B4, B5 may be associated with the functions of defrost probe 1/2, outlet probe, intake probe, condenser probe. If the cold room is very large you should also use a second probe to control the temperature of the room. The controller will activate the compressor based on the requirements of the virtual probe (Sv), obtained from weighed average of the 2 probes (B1, B2).

Par.	Description	Def	Min	Max	UoM
/4	Virtual probe composition 0 = probe B1 100 = probe B2	0	0	100	-

The /4 parameter is used to determine the virtual probe (Sv) as a weighted average of the control sensor probe B1 and B2, according to the formula:

$$Sv = \frac{[(B1 * (100 - /4) + B2 * /4)]}{100}$$

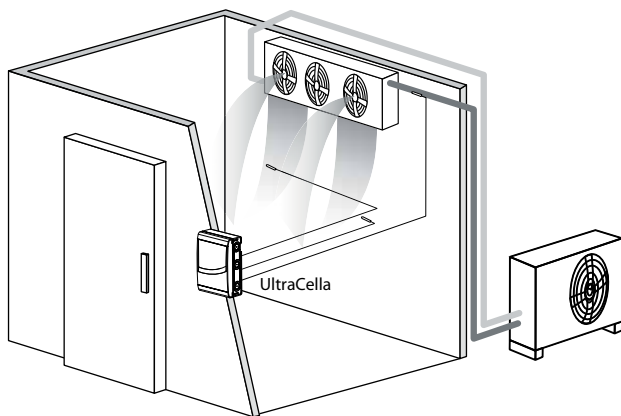


Fig. 6.a

**Key**

B1	Outlet probe
B2	Intake probe

### 6.3 Set point

The reference output is the compressor (CMP).

The controller can operate in two different modes, that can be selected using parameter r3:

- direct with defrost;
- direct without defrost;

Par.	Description	Def	Min	Max	UoM
St	Set point	0	r1	r2	°C/°F
rd	Differential	2.0	0.1	20	°C/°F
r1	Minimum set point	-50	-50	r2	°C/°F
r2	Maximum set point	60	r1	200	°C/°F
r3	Operating mode	0	0	1	-
	0 Direct with defrost				
	1 Direct without defrost				

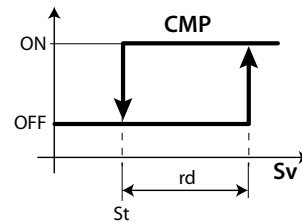


Fig. 6.b

**Key**

St	Set point
rd	Differential
Sv	Virtual probe
CMP	Compressor

If you have activated the second compressor output (H1, H5 = 13, 14) on AUX output, the activation of the compressor is at St + rd/2 and that of the auxiliary compressor AUX in St + rd, according to the figure below.

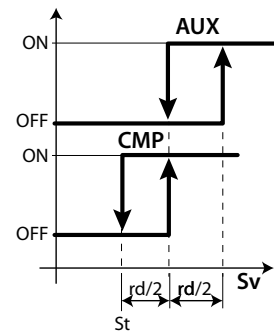


Fig. 6.c

**Key**

St	Set point
rd	Differential
Sv	Virtual probe
CMP	Compressor
AUX	Auxiliary output

The control set point, in normally operating conditions, is indicated by parameter St.

This value may however change based on other algorithms:

- Change set point from digital input (St+r4 and/or StH+r5)
- Change set point from time band (St+r4 and/or StH+r5)
- Set point variation by ramp (variable set point)

with the following priority:

Priority	Function	Control set point value
1	Set point variation from digital input (A5/A9=7)	St+r4 - StH+r5
2	Set point variation by time band	St+r4 - StH+r5
3	Set point variation (ramps)	Variable according to parameters PS1, PS2, PS3 and PH1, PH2, PH3
4	Set point by parameter St	St

### 6.3.1 Set point variation from digital input

With UltraCella, the control set point can be changed using digital inputs DI2 and DI3. This function may be useful in applications where the control set point can be increased when the store is not open to the public (for example, at night), thus guaranteeing energy savings and the certainty that the product is ready for display and sale when needed.

Digital input DI2 is associated with parameter A5, while digital input DI3 is associated with parameter A9. To enable set point variation from digital input, set A5=7 (for DI2) or A9=7 (for DI3).

Par.	Description	Def	Min	Max	UoM
A5	Configuration of digital input 2 (DI2) 7 = set point variation	0	0	15	-
A9	Configuration of digital input 3 (DI3) 7 = set point variation	0	0	15	-

When the digital input is active (closed), the control set point will be the sum of the values of parameters St and r4; when the digital input is not active (open), the control set point will be the value set for parameter St (normal operation).

- DI2 / DI3 not active (open) -> control set point = St
- DI2 / DI3 active (close) -> control set point = St + r4

Par.	Description	Def	Min	Max	UoM
r4	Set point offset	3.0	-60	60	°C/°F
r5	Humidity set point offset	0.0	-50.0	50.0	%

**Note:** when change set point is enabled and the current set point is St+r4 (and/or StH +r5), the SET button flashes to indicate that the control set point is not the value indicated by parameter St or StH.

**Note:** if the second row of the display shows the set point (/t2 = 6, on models where featured), the value displayed will be the effective control set point (therefore, either St or St + r4, depending on the status of the digital input)

### 6.3.2 Set point variation by time band

With UltraCella, the control set point can also be changed based on time bands, using the RTC fitted on the device. The function is similar to the one described in the previous paragraph, however this is more useful when needing to change the set point repeatedly at fixed times.

When the time band is active, the control set point will be the sum of the values of parameters St and r4.

- Time band not active -> control set point = St or StH
- Time band active -> control set point = St + r4 or StH + r5

Par.	Description	Def	Min	Max	UoM
r4	Set point offset	3.0	-60	60	°C/°F
r5	Humidity set point offset	0.0	-50.0	50.0	%

To activate set point variation by time band, a time band needs to be enabled by setting the following parameters:

Par.	Description	Def	Min	Max	UoM
dSn	Set point variation by time band: day 0 = disable 1, 2, ...7 = Sunday, Monday, ... Saturday 8 = Monday to Friday 9 = Monday to Saturday 10 = Saturday & Sunday 11 = every day	0	0	11	days
hSn	Start set point variation by time band: hours	0	0	23	hours
MSn	Start set point variation by time band: minutes	0	0	59	min
hSF	End set point variation by time band: hours	0	0	23	hours
MSF	End set point variation by time band: minutes	0	0	59	min
H9	Enable set point variation by time band 0/1=disabled/enabled	0	0	1	-

**Example:** to have a control set point of 4°C from Monday to Saturday, 08:30 to 18:30, and 9°C at all other times, set:

- St = 4;
- r4 = 5;
- dSn = 9;
- hSn = 8;
- MSn = 30;
- hSF = 18;
- MSF = 30;
- H9 = 1 -> if H9=0 the time band will never be active

**Note:** when change set point is enabled and the current set point is St+r4 (and/or StH +r5), the SET button flashes to indicate that the control set point is not the value indicated by parameter St or StH.

**Note:** if the second row of the display shows the set point (/t2 = 6, on models where featured), the value displayed will be the effective control set point (therefore, either St or St + r4, depending on whether or not the time band is active).

### 6.3.3 Set point ramps

Very large cold rooms used to preserve food at below-zero temperatures (freezers) may, for logistics or constructional reasons, require concrete floors. Initially, the cold room, and thus its floor, which are initially at ambient temperature, if cooled to the set point in the shortest possible time (pull down), cracks may form in the floor, causing significant damage. For this reason, in these types of cold rooms ramps of variable duration and intensity are used to bring the cold room to the set point over a time that is suitable for the concrete floor.

On UltraCella, ramps can be configured that are divided into three phases. The slope of the ramp depends on the final temperature set point and the duration of each phase.

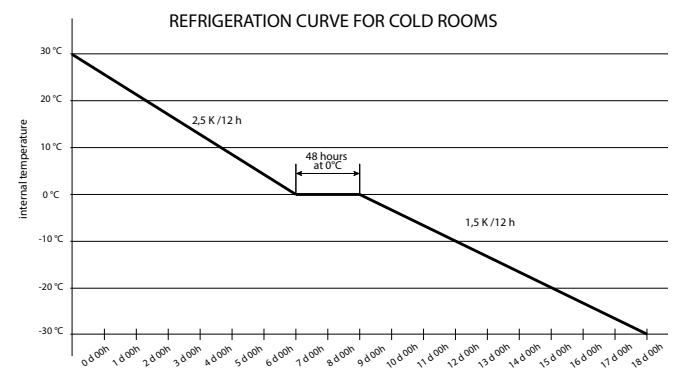
**Phase 1:** typically this is an initial cooling ramp, from ambient temperature to a final temperature around 0°C, lasting several days (default 6 days).

**Phase 2:** typically this is a phase in which the temperature reached in phase 1 is maintained, lasting several days (default 2 days)

**Phase 3:** this is the second and final cooling ramp to the final temperature set point for storing the frozen food and, being the most critical phase, typically lasts longer (default 10 days).

Par.	Description	Def	Min	Max	UoM
PS1	Ramps: final set point, phase 1	0	-50,0	200,0	°C/°F
PS2	Ramps: final set point, phase 2	0	-50,0	200,0	°C/°F
PS3	Ramps: final set point, phase 3	-30,0	-50,0	200,0	°C/°F
PH1	Ramps: duration of phase 1	6	0	10	days
PH2	Ramps: duration of phase 2	2	0	10	days
PH3	Ramps: duration of phase 3	10	0	10	days

**Example:** ramp starting from an ambient temperature of 30°C, the first phase reaches 0°C in 6 days (phase 1), maintained at 0°C for 2 days (phase 2) and final cooling ramp to the set point of -30°C over 10 days (phase 3).



**Note:** when the ramps are active, and throughout their duration, the control set point is no longer the value indicated by parameter St, but is automatically recalculated, depending on the values set for parameters PSI and PHI, every 12 hours.

**Note:** in the event of a blackout when a ramp is in progress, when power returns, the ramp resumes from where it was interrupted if the temperature in the cold room during the blackout has not increased by a value greater than parameter Pdt from the set point reached just before the blackout

- if (set point before blackout – current cold room temperature) ≤ Pdt -> brief blackout -> resume ramp from the phase where it was interrupted, with a new starting set point equal to the temperature reached by the cold room, and the phase lasts the remaining duration (as if the blackout had not occurred);
- if (set point before blackout – current cold room temperature) > Pdt -> extended black-out, the temperature has increased too much -> restart the ramp from the beginning (phase 1, PS1, PH1).

This aims to avoid damage to the floor due to an excessively fast pull down.

Par.	Description	Def	Min	Max	UoM
Pdt	Ramps: maximum set point variation after blackout	20,0	10,0	30,0	°C/°F

**Note:** At the end of the third phase, the control set point returns to the value set for parameter St -> to avoid abrupt variations, it is recommended to set PS3 = St.

**Enable ramps**

The ramps need to be enabled by setting parameter Pon=1

Par.	Description	Def	Min	Max	UoM
Pon	Enable set point ramps 1 = ramps enabled	0	0	1	-

1. Set Pon=1;
2. The evaporator fans are activated for 3 minutes (fan relay ON and analogue output at the maximum value corresponding to parameter F6, if enabled);
3. Initial ramp set point = Sv (virtual control probe, which coincides with the current cold room temperature);
4. The controller adjusts the control set point based on parameters PS1, PS2, PS3 and PH1, PH2, PH3. During each phase, the control set point is recalculated every 12 hours;
5. At the end of the phase (duration PH3), the ramps are automatically disabled (Pon=0) and the control set point is once again the value of St.

**Note:** when the ramps are enabled, and throughout their duration, the SET button flashes to indicate that the control set point is no longer the value set for parameter St.

**Note:** if the second row of the display shows the set point (/t2 = 6, on models where featured), the value displayed will be the effective control set point.

**Note:** to restart the ramps, reset Pon=1

**Note:** the ramps are always disabled if set point variation from digital input / time band is active

**Note:** the ramps can be activated even when UltraCella is OFF

**Note:** to skip a specific phase of the ramp, set PHI=0 (i=1, 2 or 3)

**6.4 Pump down**

The pump down has the aim to completely empty the evaporator of the refrigerant at each stop of the compressor. After this phase, you can safely turn off the compressor, so that the liquid is not present the next time the compressor is started. When the set point is reached, the control closes the pump down valve to stop the flow of refrigerant to the evaporator, and, after a certain time, the compressor. In the application diagram there are the pump down valve and the low pressure switch. When the control requires turning on the compressor, if the safety periods c1 and c2 have passed, the pump down valve is opened and after the time set in parameter c8 the compressor is activated.

Par.	Description	Def	Min	Max	UoM
c7	Maximum pump down time (PD) 0 = Pump down disabled.	0	0	900	s
c8	Compressor start delay after opening of pump down valve PD	5	0	60	s
H1	AUX1 output configuration ...5 = pump down valve	1	0	17	-
H5	AUX2 output configuration ...5 = pump down valve	1	0	17	-

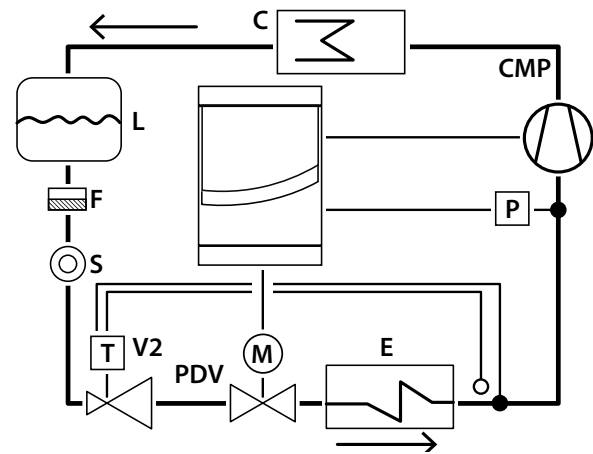


Fig. 6.d

**Key**

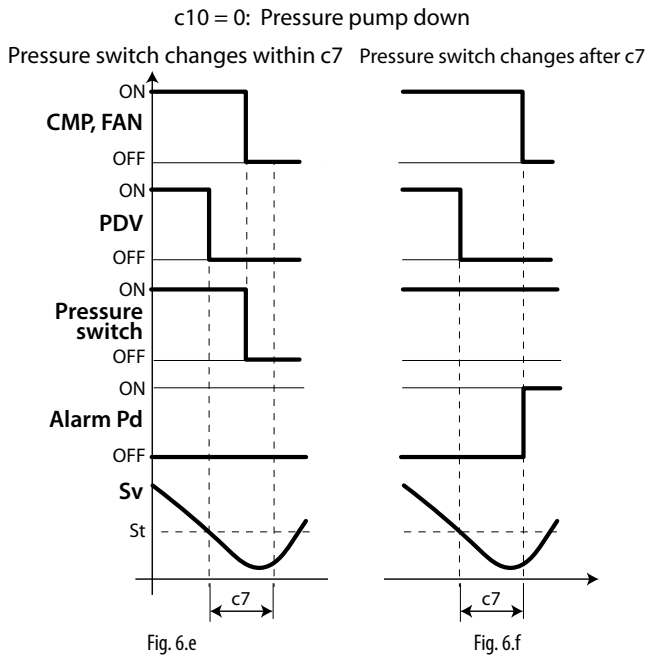
CMP	Compressor
C	Condenser
L	Liquid receiver
P	Low pressure switch
F	Dehydrator filter
E	Evaporator
S	Liquid indicator
V2	Thermostatic expansion valves
PDV	Pump down valve

**Note:** time c8 is ignored when pump down is disabled (c7=0). In this case, the pump down valve (H1=5 or H5=5) can be used to control a solenoid valve, whose operation always matches the compressor output. c8 is also ignored when pump down is enabled (c7>0) and the compressor OFF time is 0 (c2= 0).

You can select the pump down:

- on pressure (pressure switch mandatory): once the pump down valve closes, the compressor continues to operate until reaching the low pressure value (contact opened). At this point the compressor is turned off. If the pressure switch does not change within the time c7, alarm "Pd" triggers, pump down ended due to time-out. The Pd alarm is reset automatically if in the next pump down low pressure is reached within the time c7.
- on time (pressure switch optional): after the valve closes, the compressor operates for the time c7. The 'Pd' alarm, Pump down ended by time-out, is deactivated.





Key

CMP, FAN	Compressor, fan
PDV	pump down valve
Pressure switch	Pressure switch
Sv	Virtual probe
c7	Pump down maximum time
Pd	Pump down alarm
t	Time
St	Set point

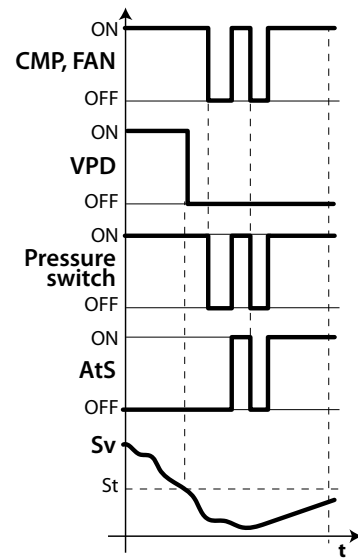
Note:

- if during the pump down there is a new demand for cooling, the pump down procedure terminates, and the pump down valve is opened (the compressor is already on from the previous pump down phase);
- in case of "Pd" alarm the auto-start function is disabled.

### 6.5 Autostart in pump down

As seen in the previous paragraph, once you reach the set point, the control closes the pump down valve and then the pressure switch changes and signals low pressure. If, due to problems of sealing of the valve, the pressure switch changes again, you can reactivate the compressor with the Auto start function, signalled by the message "Ats". This message is erased on the next correct pump down cycle

Par.	Description	Def	Min	Max	UoM
c9	Autostart in pump down	0	0	1	-
	0 whenever pump down valve closes				
	1 whenever pump down valve closes & every request of low pressure switch without regulation request				



Note: low pressure = pressure off/open.

Key

CMP, FAN	Compressor, fan	t	Time
VPD	Pump down valve	AtS	Autostart in pump down
St	Set point	Pressure switch	Pressure switch
Sv	Control probe		

Notes:

- at compressor autostart, the safety times c1 and c2, not c3 are respected;
- the message "AtS" is reset automatically on the next correct pump down cycle.

### 6.6 Continuous cycle

To activate the continuous cycle by keyboard see Chapter 3 (parameter value cc > 0). During operation in a continuous cycle, the compressor continues to operate regardless the control, for the time "cc", to lower the temperature even below the set point. The continuous cycle is stopped after the time cc or when reaching the minimum specified temperature, corresponding to the minimum temperature alarm threshold (AL). If, after the end of the continuous cycle, the temperature falls below the minimum temperature threshold, the low temperature alarm signal can be ignored by suitably setting the c6 parameter: the alarm bypass delay time after continuous cycle.

Par.	Description	Def	Min	Max	UoM
cc	Continuous cycle duration	0	0	15	hour
c6	Low temperature alarm delay after continuous cycle	2	0	250	hour
A5	Digital input configuration 2 (DI2)	0	0	15	-
	... 14 = Continuous cycle activation				
A9	Digital input configuration 3 (DI3)	0	0	15	-
	... 14 = Continuous cycle activation				

### 6.7 Door switch control

See chap. 4



### 6.8 Defrost

#### Introduction

These parameters (dd1...dd8) can be used to set up to 8 defrost events linked to the system clock (RTC)

Par.	Description	Def	Min	Max	UoM
dd1...8	Defrost 1...8: day	0	0	11	-
	0 Disabled				
	1...7 Monday...Sunday				
	8 From Monday to Friday				
	9 From Monday to Saturday				
	10 Saturday and Sunday				
	11 Daily				
hh1...8	Defrost 1...8: hour	0	0	23	hour
nn1...8	Defrost 1...8: minute	0	0	59	min.

UltraCella allows you to manage the following types of defrost, depending on parameter d0:

- 0. electric heater defrost by temperature (placed near the evaporator);
- 1. hot gas defrost by temperature.
- 2. electric heater defrost by time;
- 3. hot gas defrost by time.

**Note:** Ed1 and Ed2 indicate that the defrost ended due to time-out.

**Note:** Ed1 and Ed2 alarms can be disabled by A8 parameter.

Par.	Description	Def	Min	Max	UoM
A8	Ed1, Ed2 enable 0/1= disabled/enabled	0	0	1	-

The end of the defrost cycle can be by temperature, and in this case it is necessary to install the defrost probe Sd (to select between B2 and B3) or by time. In the first case the defrost ends if the probe Sd measures a value greater than the value of dt1 or dP1 time has elapsed, in the second case if the defrosting phase exceeds the maximum time dP1. At the end of the defrost the controller can enter in dripping status (present if dd > 0), in which the compressor and the fans are turned off, and subsequently in the state of post-dripping (if present Fd > 0), in which the control resumes with fans off. You can choose the display on the user terminal during defrost, using parameter d6.

Par.	Description	Def	Min	Max	UoM
d0	Type of defrost	0	0	3	-
	0 Heater by temperature				
	1 Hot gas by temperature				
	2 Heater by time				
	3 Hot gas by time				
dt1	End defrost temperature, main evaporator	4	-50	200	°C/°F
dt2	End defrost temperature, auxiliary evaporator	4	-50	200	°C/°F
dP1	Maximum defrost duration	30	1	250	min
dP2	Maximum defrost duration, auxiliary evaporator	30	1	250	min
d6	Terminal display during defrost	1	0	2	-
	0 = Temperature alternated with dEF				
	1 = Last temperature shown before defrost				
	2 = dEF				

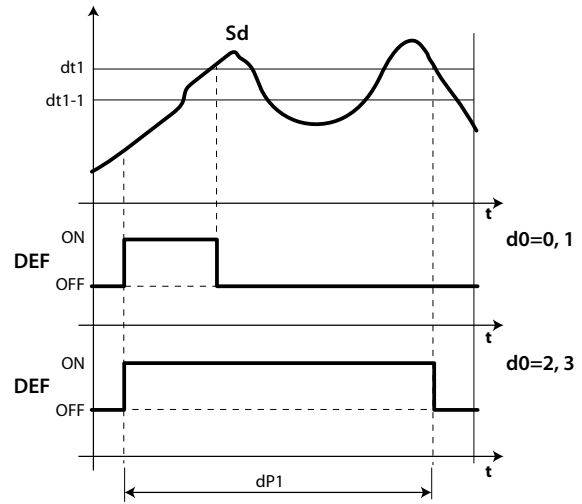


Fig. 6.h

#### Key

t	Time
dt1	End of defrost temperature
dP1	Maximum defrost duration
Sd	Defrost Probe
d0	Type of defrost
DEF	Defrost

#### 1. electric heater defrost (d0 = 0, 2): operating cycle.

The operating cycle refers to default values of the parameters F2 and F3.

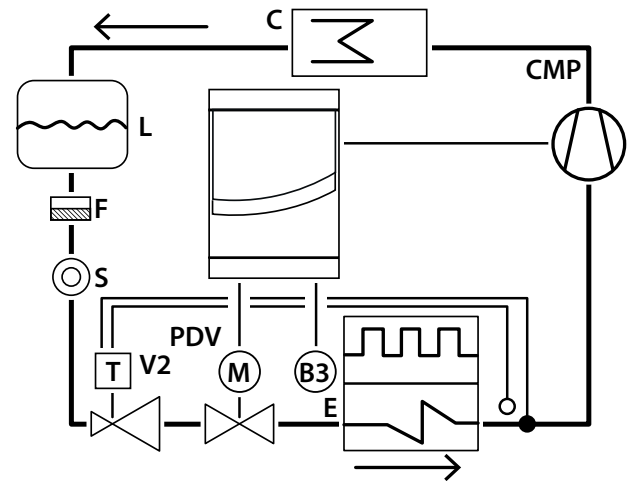


Fig. 6.i

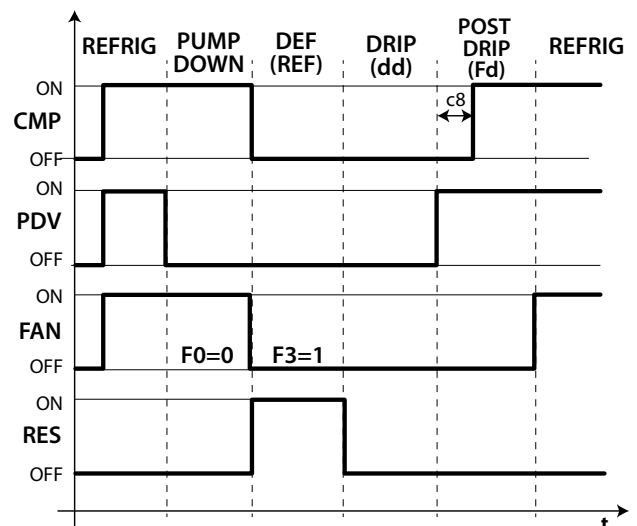


Fig. 6.j

#### Key

CMP	Compressor
Refrig	Refrigeration
PDV	Pump down valve
Pump down	Pump down phase
FAN	Evaporator fan
Def	Defrost
RES	Resistance (defrost heater)
Drip	Drip
E	Evaporator
Post drip	Post drip
C	Condenser
V2	Thermostatic expansion valve
F	Dehydrator filter
t	Time
B3	Defrost probe
L	Liquid receiver
S	Liquid indicator

Key

CMP	Compressor
Refrig	Refrigeration
FAN	Evaporator fan
Def	Defrost
V_def	Hot gas valve
Drip	Drip
E	Evaporator
Post drip	Post drip
C	Condenser
B3	Defrost probe
V2	Thermostatic expansion valve
L	Liquid receiver
F	Dehydrator filter
S	Liquid indicator
t	Time

Note:

- in pump-down the fan activation is determined by F0;
- in defrost the fan activation is determined by F3.

2. hot gas defrost (d0 = 1, 3): operating cycle.

The operating cycle refers to default values of the parameters F2 and F3.

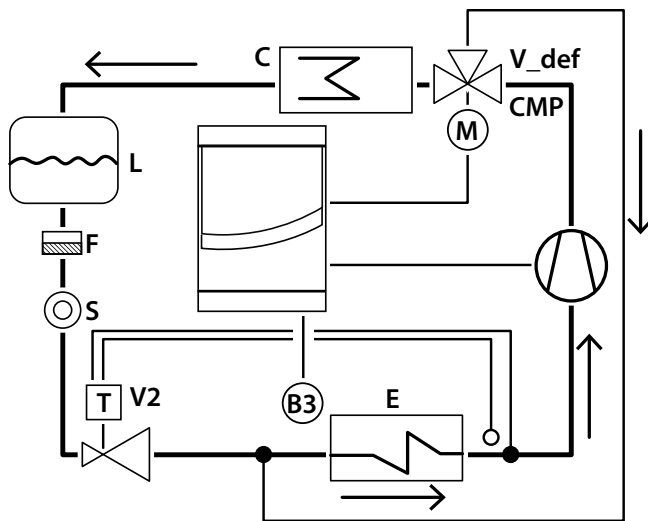


Fig. 6.k

Note:

the defrost output (DEF) is used for command of the hot gas valve V\_def.

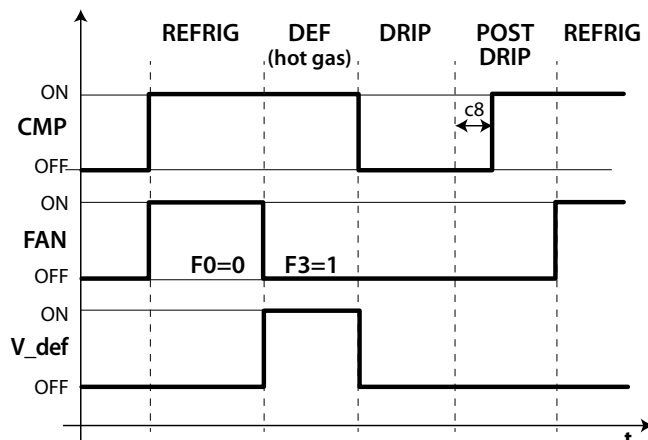


Fig. 6.l

The defrost is activated, upon priority:

- from keyboard, using the defrost key;
- from clock, setting the event and the starting mode, with maximum 8 defrosts a day (parameters dd1...dd8);
- setting the cyclic range "dl";
- from digital input;
- from supervisor.

The defrost is disabled:

- defrost by temperature: when the defrost probe detects a temperature greater than the defrost end temperature dt1;
- defrost by time: in the absence of the defrost probe, the defrost ends after the maximum time set by parameter dP1.

6.8.1 Maximum period of time between consecutive defrosts

Par.	Description	Def	Min	Max	UoM
dl	Maximum interval between consecutive defrosts 0 = defrost not performed	8	0	250	hour

The parameter dl is a security parameter that allows cyclical defrosts every "dl" hours even in the absence of the Real Time Clock (RTC). At the beginning of each defrost cycle, regardless of duration, a count is started. If the dl time is exceeded without performing any defrost, the defrost is automatically activated. The counter remains active even if the controller is off.

Example: in case of failure for example at RTC the scheduled defrost by td3 (= dd3, hh3, nn3) is not made, after the safety time dl starts a new defrost.

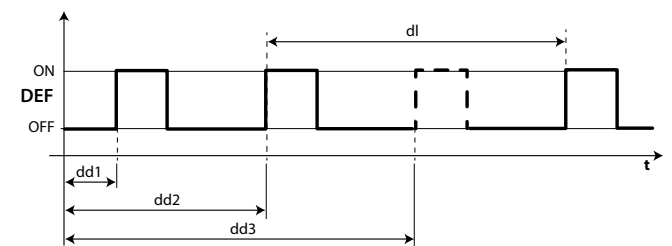


Fig. 6.m

Key

dl	Maximum interval of time between consecutive defrosts
dd1...dd3	Scheduled defrosts
DEF	Defrost
t	Time

Note:

- if the interval dl expires when the controller is OFF, when it is started again a defrost is performed;
- to ensure regular defrosts, the interval between defrosts must be greater than the maximum defrost duration, plus the dripping time and post-dripping time;
- if setting dl=0 the defrost is performed only if activated from keyboard or by setting the scheduled defrosts (ddi).

**6.8.2 Other defrost parameters**

Par.	Description	Def	Min	Max	UoM
d3	Defrost activation delay	0	0	250	min
d4	Defrost at start-up 0/1=No/Yes	0	0	1	-
d5	Defrost delay at start-up	0	0	250	min
d8	High temperature alarm delay after defrost (and door open)	1	0	250	hour
dpr	Defrost priority over continuous cycle 0/1=No/Yes	0	0	1	-

- d3 determines the time that must elapse, when the defrost is activated, between the stopping of the compressor (electric heater defrost) or the starting of the compressor (hot gas defrost), and the activation of the defrost relays on the main and auxiliary evaporators. In the hot gas defrost, the delay d3 is useful for ensuring a sufficient amount of hot gas before activation of the hot gas valve;
- d4 determines whether to activate or not the defrost at the controller start-up. The defrost at start-up request has priority over the activation of the compressor and the continuous cycle. Force a defrost at controller start-up may be useful in special situations.

**Example:** frequent power drops inside the plant. In case of lack of voltage the tool resets the inner clock that calculates the period of time between two defrosts, starting from zero. If, in an extreme case, the frequency of the power failure were greater than the defrost frequency (e.g. a power failure every 8 hours, against a defrost every 10 hours) the controller would never perform a defrost. In a situation of this type, it is preferable to activate defrost on start-up, above all if the defrost is controlled by temperature (probe on the evaporator), therefore avoiding unnecessary defrosts or at least reducing the running times. In the case of systems with a large number of units, if selecting defrosts at start-up, after a power failure all the units will start defrosting, thus causing a voltage overload. This can cause power overload. To overcome this, the parameter d5 can be used. It adds a delay before the defrost, and this delay must obviously be different for each unit.

- d5 represents the time that elapses between the start of the controller and the start of the defrost at start-up;
- dd is used to force the stop of the compressor and the evaporator fan after a defrost cycle in order to facilitate the evaporator dripping;
- d8 indicates the time of exclusion of the high temperature alarm signalling from the end of a defrost;
- if dpr = 0, the defrost and the cycle have the same priority; if dpr = 1, if the continuous cycle is in progress and a defrost request intervenes, the continuous cycle ends and the defrost starts.

**6.9 Evaporator Fans**

**6.9.1 Fixed speed fans**

The status of the fans depends on the compressor status.

When the compressor is:

- on: the fan can also be on (F0=0) or activated based on the evaporator temperature, virtual probe Sv, based on the formula:

$$\begin{aligned} \text{if } S_d \leq (S_v - F_1) - Fr_d & \rightarrow \text{FAN} = \text{ON} \\ \text{if } S_d \geq (S_v - F_1) & \rightarrow \text{FAN} = \text{OFF} \end{aligned}$$

- off: the fan is controlled by a PWM that has duty cycle with a fixed period of 60 minutes.

$$\text{duty\_cycle} = \frac{F_2}{60}$$

Par.	Description	Def	Min	Max	UoM
F0	Evaporator fan management 0 = always on with compressor on 1 = activation depends on Sd, Sv 3 = activation based on Sd 4 = always on (independent of the compressor) 5 = activation with temperature / humidity control	0	0	2	-
F1	Fan activation temperature	5	-50	200	°C/°F
F2	Fan activation time with CMP off	30	0	60	min
F3	Evaporator fans during defrost 0/1=on/off	1	0	1	-

If the fan is off, it can be controlled by a PWM signal that has a duty cycle with a fixed period Tp of 60 min

$$\text{duty\_cycle} = \frac{F_2}{60}$$

The fan can be switched off in the following situations:

- when the compressor is off (parameter F2);
- during defrosting (parameter F3).

F0=0

The fan is always on when the compressor is on

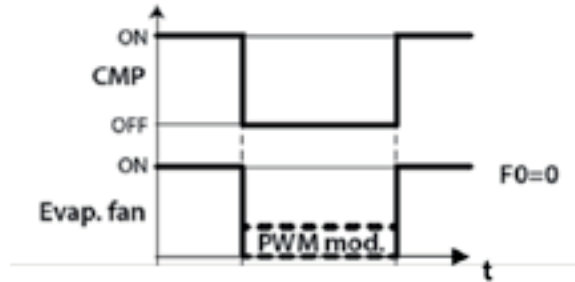


Fig. 6.n

F0=1

The fan is activated based on the evaporator temperature, and the value of the virtual probe Sv, using the formula:

$$\begin{aligned} \text{if } S_d \leq (S_v - F_1) - Fr_d & \rightarrow \text{FAN} = \text{ON} \\ \text{if } S_d \geq (S_v - F_1) & \rightarrow \text{FAN} = \text{OFF} \end{aligned}$$

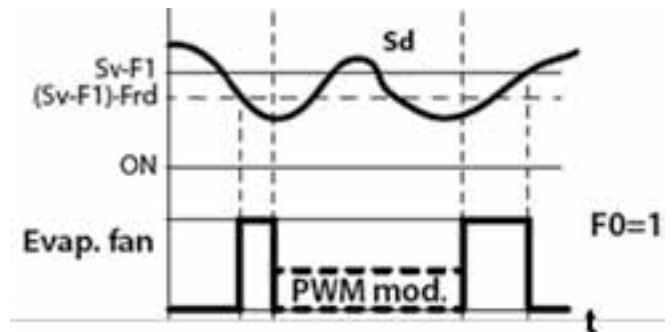


Fig. 6.o

F0=3

The fan is activated based on the evaporator temperature only, using the formula:

$$\begin{aligned} \text{if } S_d \leq F_1 - Fr_d & \rightarrow \text{FAN} = \text{ON} \\ \text{if } S_d \geq F_1 & \rightarrow \text{FAN} = \text{OFF} \end{aligned}$$

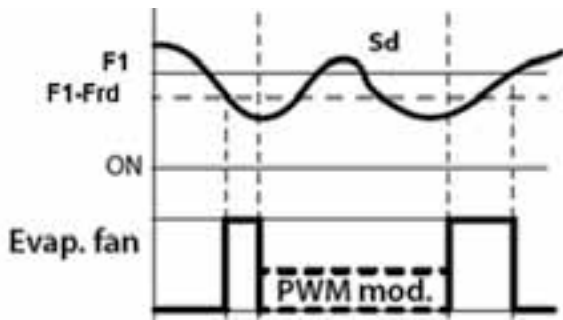


Fig. 6.p

F0=4

The fan is always on, irrespective of compressor status.

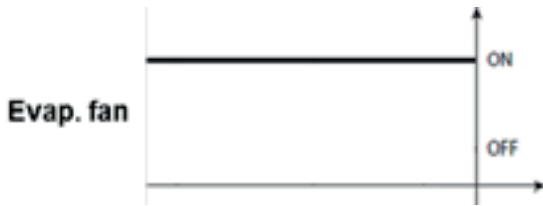


Fig. 6.q

F0=5

The fan is on if at least one of the following loads (compressor, heaters / dehumidifier, humidifier) is on

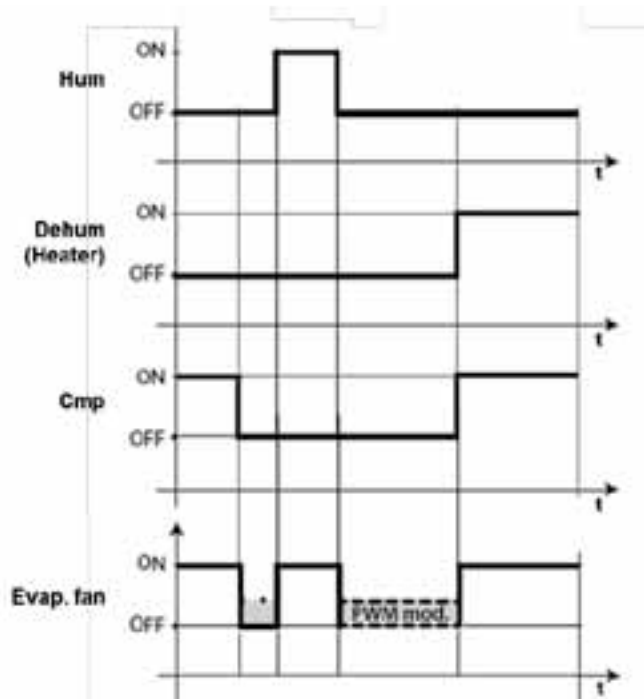


Fig. 6.r

Key

CMP	Compressor
PWM mod.	PWM modulation
F1	Fan activation threshold
Frd	Fan activation differential
Evap.fan	Evaporator fan
t	Time
Sv	Virtual probe
Sd	Defrost probe

The fan can be stopped:

- when the compressor is off (parameter F2);
- during defrost (parameter F3).

### 6.9.2 Variable speed fans

The installation of variable speed fans may be useful to optimise energy consumption. In this case, the fans are powered by the mains, while the control signal is provided by UltraCella by analogue output Y1 0...10Vdc.

The maximum and minimum fan speed can be set using F6 and F7 parameters (in percentage respect range 0...10V). If using the fan speed controller, F5 represents the temperature below which the fans are activated, with a fix hysteresis of 1°C.

Par.	Description	Def	Min	Max	UoM
F5	Evaporator fans cut-off temperature (hysteresis 1°C)	15	-50	200	°C/°F
F6	Maximum fans speed	100	F7	100	%
F7	Minimum fans speed	0	0	F6	%

To enable the algorithm, it's necessary to select variable speed fans mode (F0=2) and set analogue output 0...10Vdc (HO1=2).

Par.	Description	Def	Min	Max	UoM
F0	Evaporator fan management ... 2 = variable speed fans based on Sd 6 = variable speed fans based on Sd-Sv 7 = variable speed fans based on Sv	0	0	2	-
HO1	Output Y1 0...10V configuration ... 2 = variable speed fans regulated on Sd	0	0	3	-

**Note:** the behaviour of modulating fans may be affected not only by the "cooling" demand and temperature control request, but also by other control functions (dehumidification, humidification and heating), if present.

In order of priority, the following are possible

- If at a certain time the dehumidification function is activated, the fans will run at a fixed speed - configured by parameter F11 - for the entire duration of the dehumidification function.
- If at a certain time the heating function is activated, the fans will run at maximum speed for the entire duration of the heating function.
- If at a certain time the humidification function is activated, the fans will ensure a minimum speed - configured by parameter F12 - even when the compressor is off. The fan speed may be higher based on the logic of F0
- During the "cooling" phase, fan operation normally depends on the logic of parameter F0

Par.	Description	Def	Min	Max	UoM
F11	Fan speed during dehumidification	40	0	100	%
F12	Minimum fan speed during humidification	10	0	100	%

F0=2

The fan modulates its speed based on the evaporator temperature only, increasing speed the further Sd is below F1:

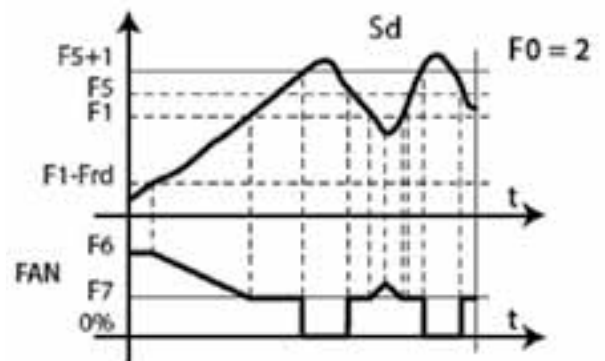


Fig. 6.s

F0=6

The fan modulates its speed based on the evaporator temperature and room temperature, increasing speed the further  $S_d$  is below  $S_v - F1$ :

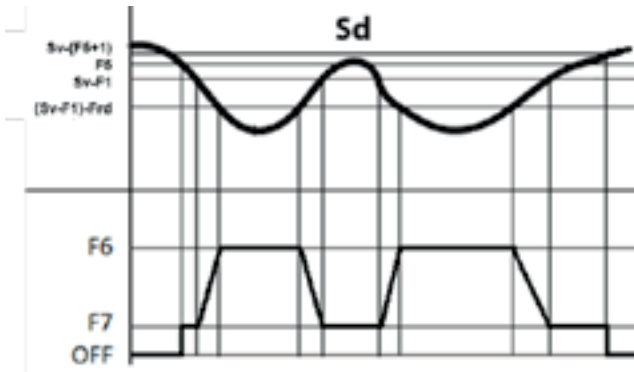


Fig. 6.t

F0=7

The fan modulates its speed based on room temperature, increasing speed the further  $S_v$  is above the set point  $St$ :

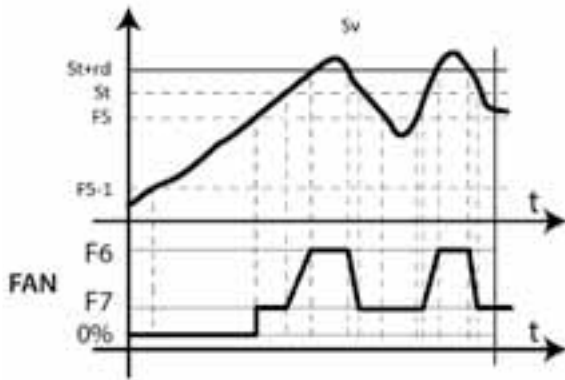


Fig. 6.u

Key

$S_d$	Evaporator probe
F0	Evaporator fans management
F1	Fan start temperature
Frd	Fan activation differential

Note:

- If two defrost probes are configured ( $S_{d1}$  and  $S_{d2}$ ), fan speed is calculated in relation to the probe that is measuring the higher temperature (so as to limit the flow of warm air):
  - if  $S_{d1} > S_{d2} \rightarrow$  control on  $S_{d1}$ ;
  - if  $S_{d1} < S_{d2} \rightarrow$  control on  $S_{d2}$ .

If a probe error occurs, fan speed is fixed at the value set for parameter F6.

- If  $F0=2$  and  $HO1=2$ , fan speed is calculated according to the algorithm in Figure 6.o. In any case, if the speed is greater than 0, the "FAN" relay DO3 is active (closed):
  - if speed ( $Y1$ ) > 0 V  $\rightarrow$  "FAN" relay ON (DO3 closed)
  - if speed ( $Y1$ ) = 0 V  $\rightarrow$  "FAN" relay OFF (DO3 open)
- If  $F0=0, 1$  (fixed speed fans on "FAN" relay DO3), the analogue output is fixed at 0 ( $Y1=0$  V)
- Within the modulation range ( $F1 - Frd < S_d < F1$ ), fan speed is modulated proportionally (e.g.:  $S_d = F1 - Frd/2 \rightarrow Y1$  corresponds to the percentage  $(F6 + F7)/2$ )

Due to motor mechanical inertia, some EC fans cannot start at the minimum speed set by the parameter F7. To overcome this problem, the fans can start at the maximum speed set by parameter F6 for a "peak time", defined by parameter F8, irrespective of the defrost temperature  $S_d$ .

Vice-versa, if the fan operates too a long at low speed, ice may form on the blades; to avoid this, at intervals of F10 minutes the fan is operated at maximum speed for the time defined by parameter F8.

Par.	Description	Def	Min	Max	UoM
F8	Fans peak time 0 = function disabled	0	0	240	s
F10	Evaporator fans forcing time at maximum speed 0 = function disabled	0	0	240	min

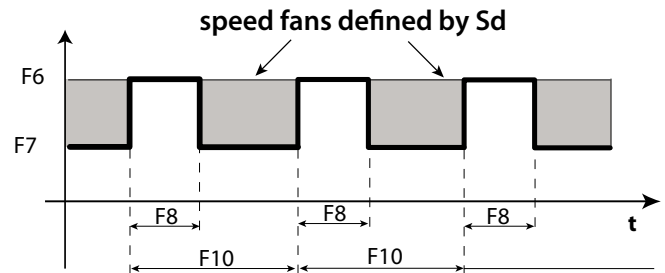


Fig. 6.v

Note: the periodical cycles at maximum speed (determined by F8 and F10) are not allowed when the cold room door is open.

### 6.9.3 Evaporator fans during defrost

The evaporator fans can be forced on both during normal control (parameter F2) and during defrost (parameter F3). During the dripping time (parameter  $dd > 0$ ) and post-dripping time (parameter  $Fd > 0$ ), the evaporator fans are always off. This is useful to allow the evaporator to return to operating temperature after defrosting, avoiding the flow of warm air across the evaporator. The time  $dd$  is used to stop the compressor and the evaporator fan after defrosting, so as to assist evaporator dripping.

Par.	Description	Def	Min	Max	UoM
F2	Fan activation time with CMP off	30	0	60	min
F3	Evaporator fans during defrost 0/1=on/off	1	0	1	-
Fd	Post dripping time (fans off)	1	0	30	min
F4	Humidity output during defrost 0/1 = ON/OFF	1	0	1	-
dd	Dripping time after defrost (fans off)	2	0	30	min

### 6.10 Condenser fans

With UltraCella, the condenser fans can be managed by one of the auxiliary relays AUX1/AUX2 (in ON/OFF mode), or by analogue output Y1 (0 to 10 V).

#### 6.10.1 Fixed speed fans

The condenser fans are activated based on parameters FC4 and A0, after configuring the digital output AUX.

Par.	Description	Def	Min	Max	UoM
FC4	Condenser fan deactivation temperature	40	-50	200	$^{\circ}C/^{\circ}F$
A0	Alarm and fan differential	2.0	0.1	20	$^{\circ}C/^{\circ}F$

Par.	Description	Def	Min	Max	UoM
H1	AUX1 output configuration ... 6 = condenser fans	0	0	17	-
H5	AUX2 output configuration ... 6 = condenser fans	0	0	17	-

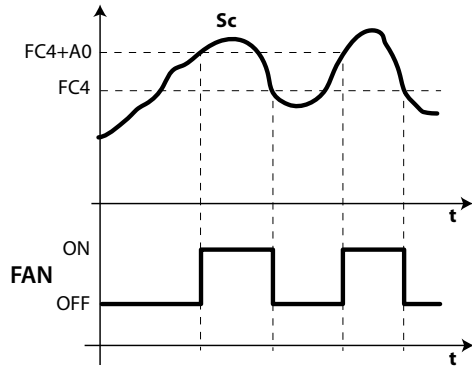


Fig. 6.w

Key

Sc	Condenser probe
FAN	Condenser fans
FC4	Turn off temperature
t	Time
A0	Differential

**Note:** if an alarm triggers at condenser probe, the output condenser fan is always on.

**6.10.2 Variable speed fans**

It may be useful to manage the fans at variable speed, in order to optimise energy consumption. In this case, the fan is powered by the mains, while the 0 to 10 Vdc control signal is supplied by UltraCella via output Y1. To activate this mode, the condensing temperature needs to be determined. This can be done in two ways:

- Using an NTC / PT1000 temperature probe connected to input B3 as a condensing temperature probe (Sc):  
/A3 = 2 (Sc)
- Connecting a pressure probe (4 to 20 mA / 0 to 5 Vrat) to input B5 as a condensing pressure probe (Scp):  
/P5 = 0 (4...20mA) / 1 (0...5Vrat)  
/A5 = 5 (Scp) -> the pressure value will be converted to a temperature (Sc) based on the type of refrigerant, defined by setting the parameter PH:

Par.	Description	Def	Min	Max	U.O.M.
PH	1 R22 15 R422D 29 R455A	3	1	40	-
	2 R134a 16 R413A 30 R170				
	3 R404A 17 R422A 31 R442A				
	4 R407C 18 R423A 32 R447A				
	5 R410A 19 R407A 33 R448A				
	6 R507A 20 R427A 34 R449A				
	7 R290 21 R245FA 35 R450A				
	8 R600 22 R407F 36 R452A				
	9 R600A 23 R32 37 R508B				
	10 R717 24 HTR01 38 R452B				
	11 R744 25 HTR02 39 R513A				
	12 R728 26 R23 40 R454B				
	13 R1270 27 R1234yf				
	14 R417A 28 R1234ze				

To activate analogue output Y1 for condenser fan control, set parameter HO1.

Par.	Description	Def	Min	Max	U.O.M.
HO1	Output Y1 configuration 3 = variable speed condenser fans	0	0	3	-

The maximum and minimum fan speed can be set using parameters FCH and FCL (as a percentage of the range from 0 to 10 V).

Par.	Description	Def	Min	Max	U.O.M.
FCH	Variable speed condenser fans: max. output value	100	FCL	100	%
FCL	Variable speed condenser fans: min. output value	0	0	FCH	%

The 0 to 10 V output is activated in direct proportional mode, centred around the condenser fan control set point FCS and differential FCd.

Par.	Description	Def	Min	Max	U.O.M.
FCS	Variable speed condenser fans: set point	15,0	-100,0	200,0	°C/°F
FCd	Variable speed condenser fans: differential	2,0	0,1	10,0	°C/°F

Example 1: extended output range, 0 to 10 V (FCL=0, FCH=100).

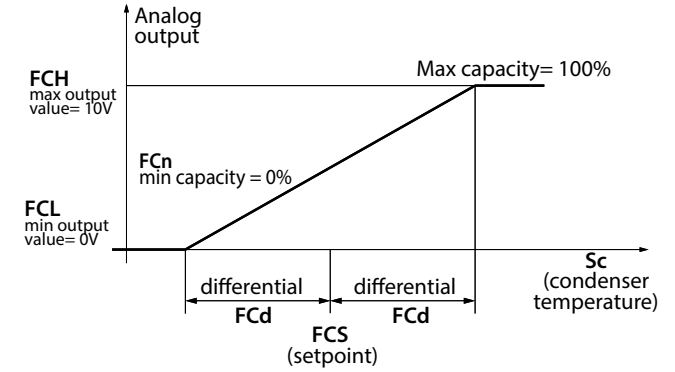


Fig. 6.x

In this example, the minimum modulation capacity FCn is 0, therefore the range of modulation of the 0 to 10 V output is:  $FCS - FCd < Sc < FCS + FCd$ .

Par.	Description	Def	Min	Max	U.O.M.
FCn	Variable speed condenser fans: min. capacity percentage	0	0	FCH	%

Example 2: extended output range, 0 to 10 V (FCL=0, FCH=100), minimum modulation capacity 60%.

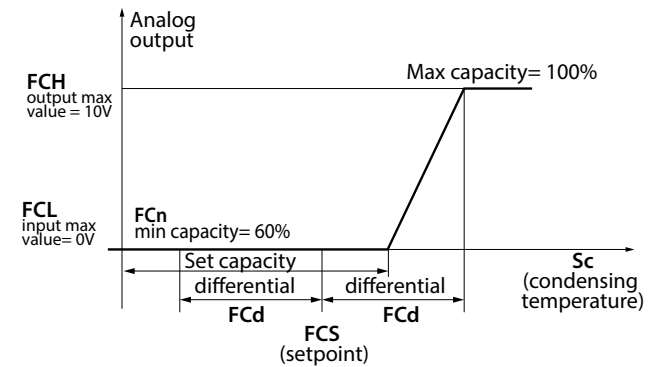


Fig. 6.y

In this example, the range of modulation of the 0 to 10 V output is:  $FCS + 0.2 * FCd < Sc < FCS + FCd$

Example 3: limited output range, 2 to 10 V (FCL=20, FCH=100), minimum modulation capacity 60%

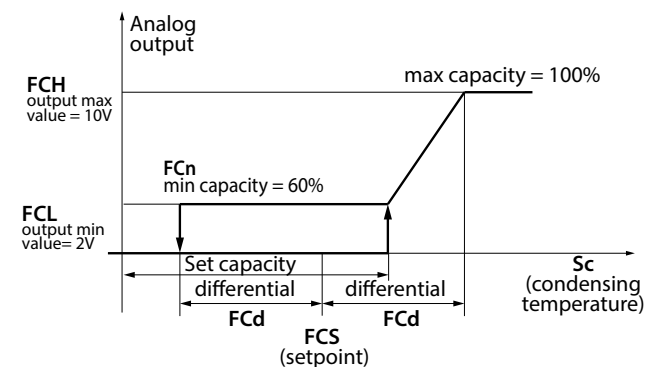


Fig. 6.z



In this example, the range of modulation is still

$$FCS+0,2*FCd < Sc < FCS+FCd$$

for starting the fans, and

$$FCS-FCd < Sc < FCS+FCd$$

for stopping (the fans stop when the condensing temperature is less than FCS-FCd).

**Note:** if a condensing temperature/pressure probe error occurs (E2 for Sc or E4 for Scp), the analogue output will take the maximum value indicated by parameter FCH, except in the following events:

- CHt (high condenser temperature alarm, if configured)
- EPM (motor protector alarm, 3PH module, if present and configured)
- EPU (high/low pressure or Kriwan alarm, 3PH module, if present and configured)

### 6.10.3 Floating condensing temperature set point

The control set point for variable speed condenser fans (parameter FCS) may be either fixed or variable (floating condensing temperature). The type of set point is selected using parameter FCT.

Par.	Description	Def	Min	Max	UoM
FCT	Variable speed condenser fans: fixed or variable set point 0/1=fixed FCS/floating	0	0	1	-

The purpose of the floating condensing temperature function is to lower the condensing temperature based on the outside temperature, so as to preserve correct compressor operation. The floating condensing temperature set point algorithm requires an outside temperature probe (SA), usually located near to the condenser, so as calculate the reference control value, as shown in the following figure:

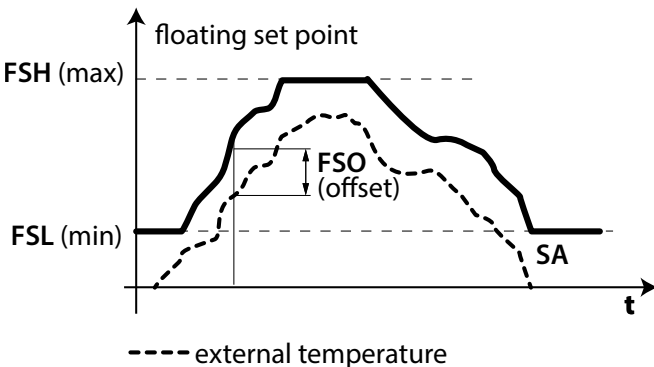


Fig. 6.aa

To activate the floating condensing temperature function, as well as setting FCT=1, B3 (parameter /A3) or B4 (parameter /A4) needs to be configured as an outside temperature probe (SA).

Par.	Description	Def	Min	Max	UoM
/A3	Probe 3 configuration ... 4 = out. temp. probe (SA)	0	0	5	-
/A4	Probe 4 configuration ... 1 = out. temp. probe (SA)	0	0	4	-

**Note:** if the outside temperature probe SA is not configured, or if the probe has an error (E2 for B3, E3 for B4), the floating condensing temperature algorithm will be disabled, and the control set point will be fixed (FCS).

The algorithm allows for the floating condensing temperature set point to vary between a minimum (parameter FSL) and a maximum (parameter FSH) and, based on the outside temperature (SA), an offset is added (parameter FSO). For details on these parameters, see the datasheet for the condenser used

Par.	Description	Def	Min	Max	UoM
FSL	Floating condensing temp. set point: min value	5,0	-100,0	FSH	°C/°F
FSH	Floating condensing temp. set point: max value	25,0	FSL	200,0	°C/°F
F50	Floating condensing temp. set point: offset	5,0	-50,0	50,0	°C/°F

### 6.11 Duty setting

In the event the alarm "rE" (virtual control probe fault), the parameter c4 is used to ensure the operation of the compressor until the fault is resolved. The compressor cannot be activated according to the temperature (due to the faulty probe), it is activated cyclically with a time of operation (ON) equal to the value assigned to c4 and a switch-off time (OFF) fixed at 15 minutes.

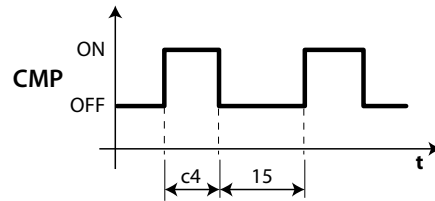


Fig. 6.ab

Par.	Description	Def	Min	Max	UoM
c4	Compressor running time in duty setting	0	0	100	min

### 6.12 Bowl resistance

The resistor is used to heat the collection tank after the defrosting phase, to prevent the ice from blocking the passage of water. The resistance is activated for 3 minutes before the programmed defrost or simultaneously with a manual defrost. The resistance is always off after the defrost phase.

Par.	Description	Def	Min	Max	UoM
H1	AUX1 output configuration ... 3 = bowl resistance activation	1	0	17	-
H5	AUX2 output configuration ... 3 =bowl resistance activation	1	0	17	-

### 6.13 Defrosting with 2 evaporators

You can configure up to 2 defrost probes and up to 2 evaporator outputs. The control recognizes the configuration based on the following table (probe 1 is the control probe and cannot be configured)

#### DEFROST PROBES AND EVAPORATORS OUTPUT CONFIGURATION

Case	Defrost probes	Evaporator outputs	Notes
1	B2	Evap. 1	B2 acts on the evap. 1
2	B2	Evap. 1 and 2	B2 acts on the evap. 1
3	B2 and B3	Evap. 1	B2 and B3 act on evap. 1 (start and end of defrost based on the minimum value probe)
4	B2 and B3	Evap. 1 and 2	B2 acts on the evap. 1 and B3 act on evap. 2

Tab. 6.b

CASE 4: 2 PROBES AND 2 EVAPORATORS

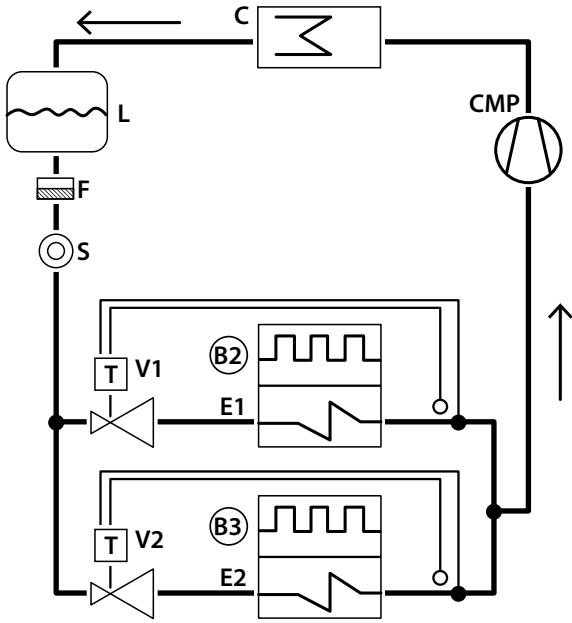


Fig. 6.ac

Key

E1/2	Evaporator 1/2
C	Condenser
V1/2	Thermostatic expansion valve 1/2
L	Liquid Receiver
B2/B3	defrost probe 2, 3
CMP	Compressor
F	Filter drier
S	Liquid indicator

Defrosts on two evaporators can be performed either simultaneously or sequentially; the latter is used above all to limit the power consumption of the two defrost heaters working at the same time.

Par.	Description	Def	Min	Max	UoM
d13	Defrost on two evaporators (0=Simultaneous - 1=Separate)	0	0	1	-

6.14 Second compressor with rotation

Second compressor output with double step control with rotation: the compressors will be turned on as follows:

- alternately for single step requests (as in example 3)
- the first to be turned on will be the first to be turned off for the 2 steps requests (as in examples 1, 2 and 4)

Par.	Description	Def	Min	Max	UoM
H1/H5	AUX1 output configuration/AUX2 14 = second compressor with rotation management	1	0	17	-

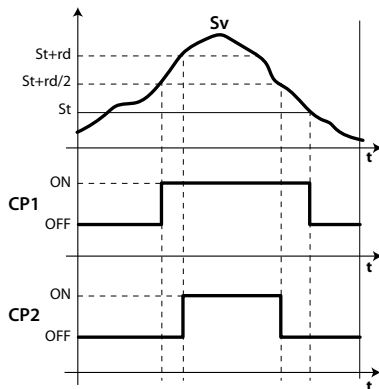


Fig. 6.ad

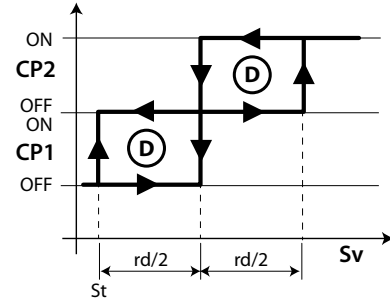


Fig. 6.ae

Key

SV	Virtual probe
CP1	Compressor 1
CP2	Compressor 2
rd	Differential
t	time
St	Set point

Operation examples: (NOTE: REQ1: Sv > St + rd/2; REQ2: Sv > St + rd)

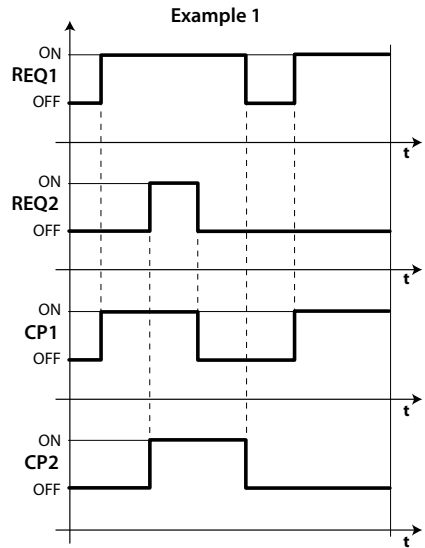


Fig. 6.af

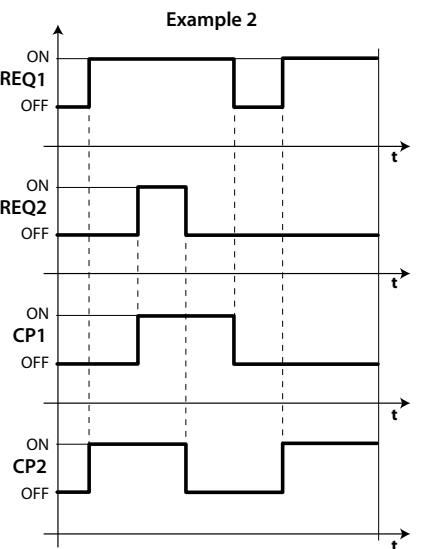


Fig. 6.ag



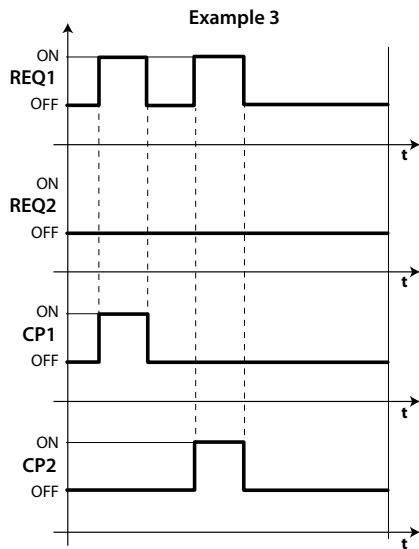


Fig. 6.ah

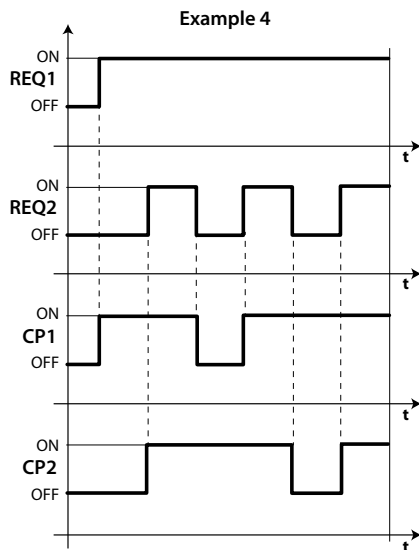


Fig. 6.ai

Key

REQ1	request 1
REQ2	request 2
t	time
CP1	compressor 1
CP2	compressor 2

### 6.15 Control with dead band

As well as the control output in direct mode (cooling, compressor), on UltraCella one of the two auxiliary outputs (AUX1/AUX2) can be selected in reverse mode (heating, by electric heater / other actuators). This type of control features an area in which the selected output is not active, called the dead band (parameter rn). Parameter rr represents the differential for the output in reverse mode.

Par.	Description	Def	Min	Max	UoM
rn	Dead band	0	0	60	°C/°F
rr	Differential for control with dead band	2,0	0,1	20	°C/°F

To activate heating/cooling control with dead band, set:

- rn > 0
- H1 = 16 (for AUX1) or H5 = 16 (for AUX2)

Par.	Description	Def	Min	Max	UoM
H1	AUX1 output configuration ... 16 = output in reverse mode for control with dead band	1	0	17	-
H5	AUX2 output configuration ... 16 = output in reverse mode for control with dead band	1	0	17	-

The figure shown below refers to heating/cooling control with dead band for a compressor (direct) with one capacity step.

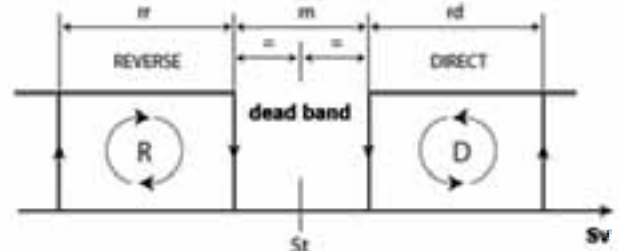


Fig. 6.aj

The following figure, on the other hand, refers to heating/cooling control with dead band for a compressor with two capacity steps.

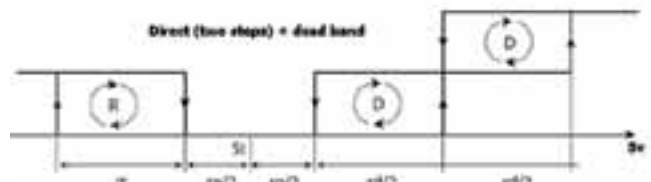


Fig. 6.ak

**Note:** the second compressor step (with or without rotation) and control with dead band both refer to the auxiliary outputs (AUX1/AUX2). If both are enabled, configure, for example H1 = 14 (AUX1 second compressor step) and H5 = 16 (AUX2 output in reverse mode (heating) with dead band)

In the same way, auxiliary outputs AUX1 / AUX2 can be used for dead band control with two-step compressor and heaters, in this case configuring:

- H1=16 reverse output with dead band
- H5 = 21 reverse output 2

### 6.16 AUX output activation by time band

With UltraCella, auxiliary outputs AUX1/AUX2 can also be activated by time band, using the RTC fitted on the device.

When the time band is active, the AUX output (H1 for AUX1, H5 for AUX2) configured will be active (ON, relay closed).

- Time band not active -> AUX output not active (OFF, relay open)
- Time band active -> AUX output active (ON, relay closed)

Par.	Description	Def	Min	Max	UoM
H1	AUX1 output configuration ... 17 = output managed by time band	1	0	17	-
H5	AUX2 output configuration ... 17 = output managed by time band	1	0	17	-

To activate an auxiliary output by time band, a time band needs to be enabled by setting the following parameters:

Par.	Description	Def	Min	Max	UoM
don	AUX activation by time band: day 0 = disable 1, 2, ...7 = Sunday, Monday, ... Saturday 8 = Monday to Friday 9 = Monday to Saturday 10 = Saturday & Sunday 11 = every day	0	0	11	days
hon	AUX activation by time band: hours	0	0	23	hours
Mon	AUX activation by time band: minutes	0	0	59	min
hoF	AUX deactivation by time band: hours	0	0	23	hours
MoF	AUX deactivation by time band: minutes	0	0	59	min
H8	Enable AUX activation by time band 0/1=disabled/enabled	0	0	1	-

Example: to activate auxiliary output AUX1 from Monday to Friday, from 07:30 to 20:00, set:

- H1 = 17;
- don = 8;
- hon = 7;
- Mon = 30;
- hoF = 20;
- MoF = 0;
- H8 = 1 -> if H8=0 the time band will never be active

**Note:** the auxiliary output is activated based on the time band even when UltraCella is OFF

**Note:** lthe status of the AUX output (if configured as active by time band) is also retained after a blackout

### 6.17 Humidity management

UltraCella can interact with CAREL humidification systems, managing the humidity level in combination with cooling control.

The humidity must be read from UltraCella, configuring an analogue input (B4 or B5) as a 0 to 10 V or 4 to 20 mA input for humidity probes. The controller can display the humidity read by the probe and, by suitably configuring one of the auxiliary outputs, AUX1 or AUX2, activate an external CAREL humidifier to adjust the humidity level accordingly.

Carel Humidification systems are compatible with UltraCella

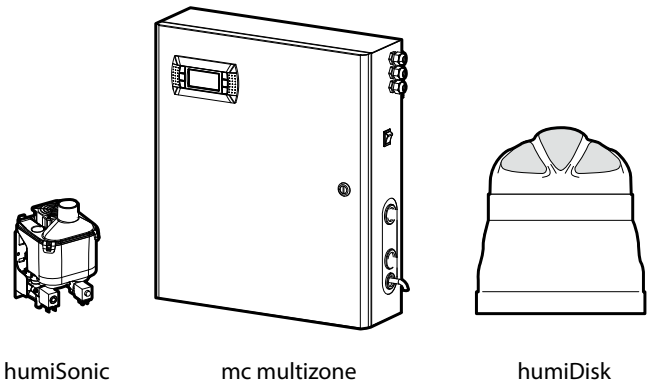


Fig. 6.al

#### Wiring diagram between UltraCella and humiSonic

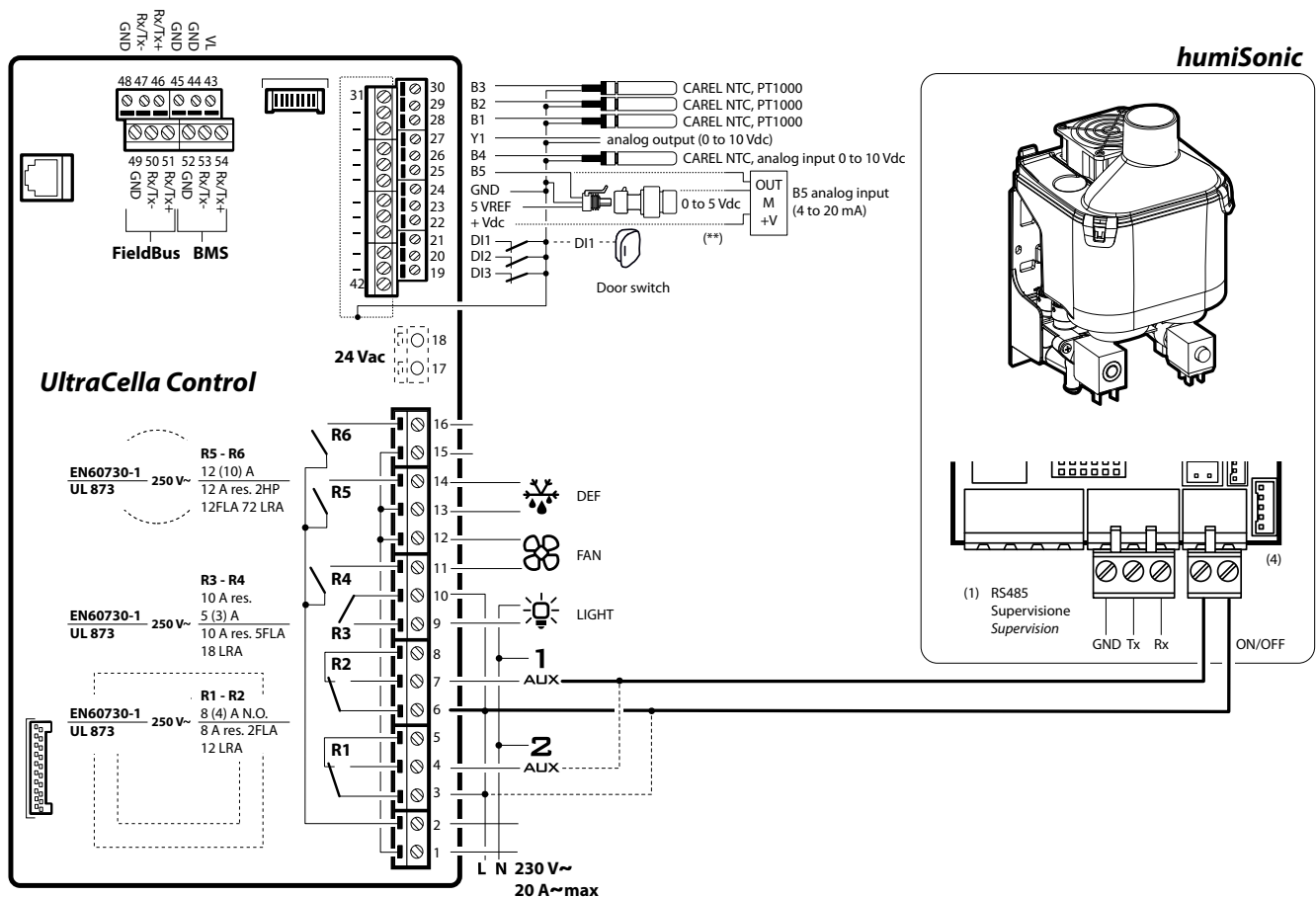


Fig. 6.am

### 6.17.1 Analogue input configuration for humidity probes

Either analogue input B4 or B5 needs to be configured a humidity probe input.

Par.	Description	Def	Min	Max	UoM
/P4	B4 configuration ... 2 = 0 to 10V	0	0	2	-
/P5	B5 configuration ... 0 = 4 to 20mA	0	0	1	-

Par.	Description	Def	Min	Max	UoM
/A4	B4 configuration ... 2 = humidity probe (Su)	0	0	4	-
/A5	B5 configuration ... 1 = humidity probe (Su)	0	0	5	-

**Example:**

Humidity probe with 0 to 10 V output -> connect the probe to input B4 and set

- /P4=2
- /A4=2

Humidity probe with 4 to 20 mA output -> connect the probe to input B5 and set

- /P5=0
- /A5=1

### 6.17.2 Display humidity reading on UltraCella

On models with single row display, P/Ns WB000S\*, the humidity can be displayed instead of the cold room temperature, selecting:

- Humidity probe with 0 to 10 V output -> /t1=10 (B4)
- Humidity probe with 4 to 20 mA output -> /t1 = 11 (B5)

Par.	Description	Def	Min	Max	UoM
/t1	Variable 1 on the display ... 10 = B4 11 = B5	1	0	13	-

On models with double row display, P/Ns WB000D\*, the humidity can be displayed on the second row as the second process selecting:

- Humidity probe with 0 to 10 V output -> /t2=10 (B4)
- Humidity probe with 4 to 20 mA output -> /t2 = 11 (B5)

Par.	Description	Def	Min	Max	UoM
/t2	Variable 2 on the display (second row) ... 10 = B4 11 = B5	6	0	23	-

### 6.17.3 AUX1 / AUX2 auxiliary output configuration and basic humidity control logic

To activate the humidifier connected to UltraCella, configure one of the auxiliary outputs AUX1 or AUX2 for humidity control.

Par.	Description	Def	Min	Max	UoM
H1	AUX1 output configuration ... 15 = humidity output	1	0	17	-
H5	AUX2 output configuration ... 15 = humidity output	1	0	17	-

Basic humidity control logic: if the humidity measured is less than the set point StH, the relay activates the externally connected humidifier (REVERSE action, standard ON/OFF with differential).

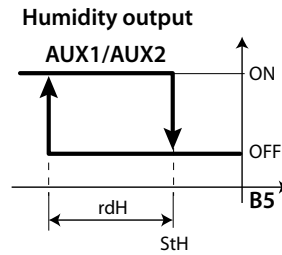


Fig. 6.an

**Key**

StH	Humidity set point
rdH	Humidity differential
B5	Probe B5 configured as 4 to 20 mA humidity probe

Par.	Description	Def	Min	Max	UoM
StH	Humidity set point	90.0	0.0	100.0	%rH
rdH	Humidity differential	5.0	0.1	20.0	%rH



**Note:**

- Humidity control can be disabled during defrosting (parameter F4):
  - F4=0 -> humidity control enabled based on humidity set point StH;
  - F4=1 -> humidity control not enabled: during defrost, the external humidifier will not be activated.
- Humidifier activation (AUX1/AUX2 relay) is always disabled in the event of an alarm that immediately stops the compressor. Examples:
  - CHT alarm;
  - LP alarm (after 3 times);
  - IA alarm (when A6=0).

Par.	Description	Def	Min	Max	UoM
F4	Humidifier relay during defrost 0 = relay enabled in defrost (based on StH) 1 = relay not enabled in defrost	1	0	1	-

### 6.18 Dehumidification

Using the same configuration of the probes as described in the previous paragraph, UltraCella can also manage dehumidification:

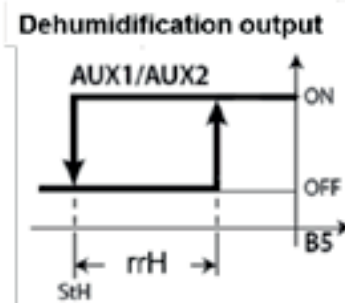


Fig. 6.a0

or humidity control with dead band:

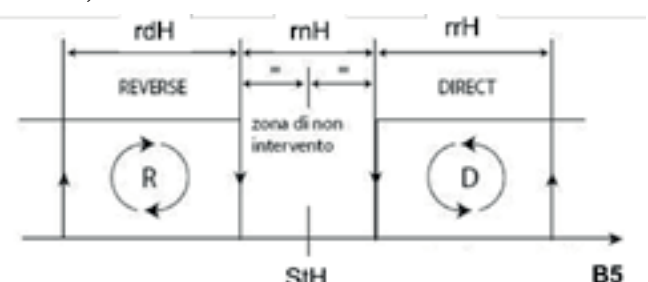


Fig. 6.ap

Dehumidification requires simultaneous cooling (compressor) and heating (heater). The cooling effect is to reduce the air's relative humidity, while the heater offsets excessive cooling, keeping a virtually constant temperature in the cold room throughout the process.

For example, relay AUX2 can be used to enable the heaters, setting H5=19 to exploit the dehumidification logic.

**Note:** a stand-alone external dehumidifier can also be used; in this case, the operating logic is completely separate from the compressor's. The function can be configured by setting H1 or H1 or H5 = 20.

**Note:** activation of one of the auxiliary relays for dehumidification automatically enables dead band temperature control with rn=1

For humidity control with dead band, the humidifier also needs to be connected to relay AUX1, setting parameter H1=15

**Note:** activation of one of the two auxiliary relays for dehumidification and the other for humidification, automatically enables dead band humidity control with rnH=5 (as well as dead band temperature control, as described above)

The control parameters are as follows:

Par.	Description	Def	Min	Max	UoM
StH	Humidity set point	90.0	0.0	100.0	%rH
rdH	Humidity differential	5.0	0.1	20.0	%rH
rrH	Dehumidification differential	5.0	0.0	50.0	%
rnH	Humidity dead band	5.0	0.0	50.0	%
TLL	Minimum temperature to enable humidity control	0.0	-60.0	60.0	°C/°F
THL	Maximum temperature to enable humidity control	0.0	-60.0	60.0	°C/°F
TdL	Temp. differential to enable humidity control	0.0	0.0	20.0	°C/°F
r5	Humidity set point offset	0.0	-50.0	50.0	%

### 6.18.4 Simultaneous humidity and temperature control

When both values are controlled simultaneously, generally humidity control is independent of temperature control.

Humidity control can be bound within a defined temperature range (parameters TLL and THL and the corresponding differential TdL), so as to avoid excessive temperature deviations during humidity control.

**Note:** if parameters TLL and / or THL are 0, they are ignored by the control logic

#### Case 1: Humidity control independent of temperature (default)



Fig. 6.aq

Temperature is controlled only after the humidity set point has been reached

#### Case 2: Humidity control within a range

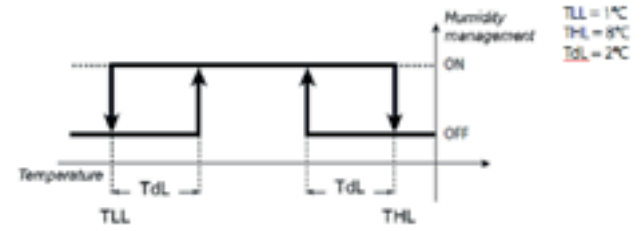


Fig. 6.ar

Humidity is controlled in a sequence of cycles, ensuring the temperature always remains inside the range 1°C – 8°C

#### Case 3: Humidity control with upper temperature limit

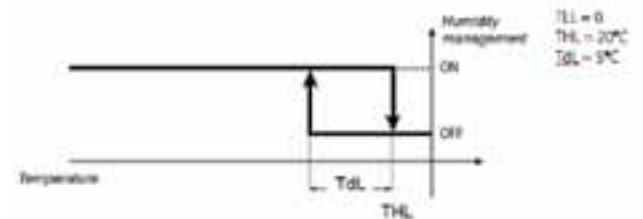


Fig. 6.as

This configuration, if the heater is oversized, prevents the temperature from exceeding the limit of 20°C during dehumidification.

#### Case 4: Humidity control with lower temperature limit

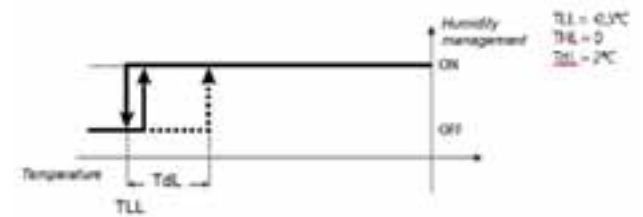


Fig. 6.at

This configuration is used to stop humidification below -0.5°C (for example, fresh fruit storage with humidification)

**Note:** in the event of humidity probe errors (for example B5) humidification and dehumidification are managed in "duty cycles". This is only possible in humidification-only and dehumidification-only modes, are not in humidity control with dead band.

Par.	Description	Def	Min	Max	UoM
U1	Humidity control duty cycle ON time	10	0	120	min
U2	Humidity control duty cycle OFF time	60	0	120	min

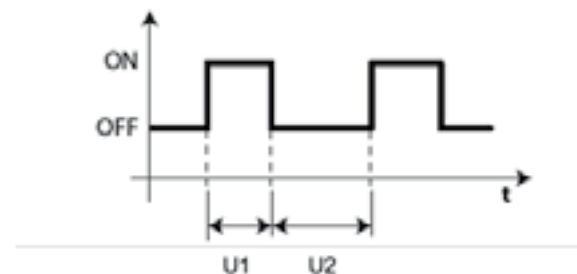


Fig. 6.au

### 6.19 Generic functions

With UltraCella, a number of generic functions can be configured, and associated with configurable inputs and outputs that have not already been configured for other uses.

The following functions are available:

- 3 ON/OFF control functions, using outputs AUX1/AUX2 (AUX3 / AUX4 see paragraph 6.20)
- 1 modulating control function, using output Y1 (0 to 10 V)
- 2 alarms, using outputs AUX1/AUX2 (AUX3 / AUX4 see paragraph 6.20)

The generic ON/OFF or 0 to 10 V modulating control functions can be associated with an input that also has other functions (for example Sv, control probe, or Su, humidity probe), or to a free input that therefore needs to be configured specifically.

Par.	Description	Def	Min	Max	UoM
/A2	Probe 2 configuration 3 = generic temperature probe 2	0	0	3	-
/A3	Probe 3 configuration 5 = generic temperature probe 3	0	0	5	-
/A4	Probe 4 configuration 3 = generic temperature probe 4 4 = generic humidity probe 4	0	0	4	-
/A5	Probe 5 configuration 2 = generic temperature probe 5 3 = generic humidity probe 5 4 = generic pressure probe 5	0	0	5	-

The generic alarm functions can be associated with an alarm already featured on UltraCella (for example CHt, high condenser temperature alarm, or LP, low pressure alarm), or to digital inputs D12/DI3, which therefore need to be configured specifically.

Par.	Description	Def	Min	Max	U.o.M
A5	Configuration of digital input DI2 15 = alarm from generic function	0	0	15	-
A9	Configuration of digital input DI3 15 = alarm from generic function	0	0	15	-

#### 6.19.5 ON/OFF control functions

UltraCella can manage 3 ON/OFF control functions in direct or reverse mode, based on a configurable set point and differential. The control variable is defined by parameter AS1 (AS2).

Par.	Description	Def	Min	Max	UoM
AS1	ON/OFF control 1: control variable configuration	3	0	14	-
	0 Sm 8 generic temperature probe 2				
	1 Sd1 9 generic temperature probe 3				
	2 Sr 10 generic temperature probe 4				
	3 Sv 11 generic temperature probe 5				
	4 Sd2 12 generic humidity probe 4				
	5 Sc 13 generic humidity probe 5				
	6 SA 14 generic pressure probe 5				
	7 Su				
r1S	ON/OFF control 1: mode 0/1=direct/reverse	0	0	1	-
SS1	ON/OFF control 1: set point	0,0	-50,0 0,0 -20,0	200,0 100,0 999	°C/°F/ rH%/ bar/ psi
rS1	ON/OFF control 1: differential	2,0	0,1	20,0	°C/°F/ rH%/ bar/ psi

AS2	ON/OFF control 2: control variable configuration	3	0	14	-
	0 Sm 8 generic temperature probe 2				
	1 Sd1 9 generic temperature probe 3				
	2 Sr 10 generic temperature probe 4				
	3 Sv 11 generic temperature probe 5				
	4 Sd2 12 generic humidity probe 4				
	5 Sc 13 generic humidity probe 5				
	6 SA 14 generic pressure probe 5				
	7 Su				
r2S	ON/OFF control 2: mode 0/1=direct/reverse	0	0	1	-
SS2	ON/OFF control 2: set point	0,0	-50,0 0,0 -20,0	200,0 100,0 999	°C/°F/ rH%/ bar/ psi
rS2	ON/OFF control 2: differential	2,0	0,1	20,0	°C/°F/ rH%/ bar/ psi

To enable the function, set AS1/AS2 to a value greater than 0. To use outputs AUX1/AUX2 for generic ON/OFF functions, set parameters H1/H5.

Par.	Description	Def	Min	Max	U.o.M
H1	AUX1 output configuration 8 = Generic ON/OFF control function 1 9 = Generic ON/OFF control function 2	0	0	17	-
H5	AUX2 output configuration 8 = Generic ON/OFF control function 1 9 = Generic ON/OFF control function 2	0	0	17	-

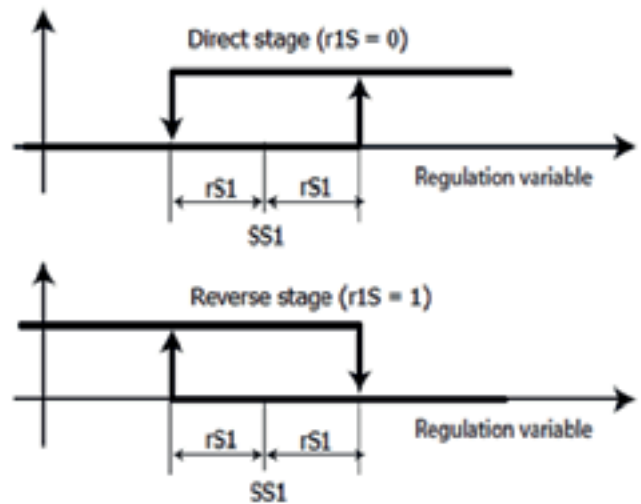


Fig. 6.av

For each ON/OFF control function, two alarm absolute thresholds and an alarm notification delay can be set.

Par.	Description	Def	Min	Max	U.o.M
AL1	ON/OFF control 1: absolute low alarm threshold	0,0	-50,0 0,0	200,0 100,0	°C/°F/ rH%/ bar/psi
AH1	ON/OFF control 1: absolute high alarm threshold	0	-50,0 0,0 -20,0	200,0 100,0 999	°C/°F/ rH%/ bar/psi
Ad1	ON/OFF control 1: alarm delay	0	0	250	min
AL2	ON/OFF control 2: absolute low alarm threshold	0,0	-50,0 0,0 -20,0	200,0 100,0 999	°C/°F/ rH%/ bar/psi

Par.	Description	Def	Min	Max	U.o.M
AH2	ON/OFF control 2: absolute high alarm threshold	0	-50.0 0.0 -20.0	200.0 100.0 999	°C/°F/ rH%/ bar/psi min
Ad2	ON/OFF control 2: alarm delay	0	0	250	min

The following alarms are generated by the functions:

- GL1, GL2: alarms when exceeding low thresholds AL1, AL2
- GH1, GH2: alarms when exceeding high thresholds AH1, AH2

Example 1: ON/OFF control 1 based on pressure (input B5, 4 to 20 mA) with direct action via AUX1. Control set point 15 bars, differential 3 bars. Set:

- /P5 = 0 -> input B5 to 4 to 20 mA
- /A5 = 4 -> generic pressure probe 5
- AS1 = 14 -> generic pressure probe 5
- r1S = 0 -> direct action
- SS1 = 15 -> control set point 15 bars
- rS1 = 3 -> differential 3 bars
- H1 = 8 -> output AUX1 for ON/OFF control 1

Example 2: ON/OFF control 2 based on humidity (input B4, 0 to 10V) with reverse action on AUX2. Control set point 75% rH, differential 10% rH. Set:

- /P4 = 2 -> input B4 to 0 to 10 V
- /A4 = 4 -> generic humidity probe 4
- AS2 = 12 -> generic humidity probe 4
- r2S = 1 -> reverse action
- SS2 = 75 -> control set point 75% rH
- rS2 = 10 -> differential 10% rH
- H5 = 9 -> output AUX2 for ON/OFF control 2

**Note:** the third generic ON/OFF control function can be configured by setting parameter AS3 in the same way as for AS1/AS2 (see the parameter table). If all three generic functions available are used, outputs AUX3 (parameter H13) and AUX4 (parameter H14) can also be used, suitably re-configuring the relays on UltraCella (see paragraph 6.20 for further information)

### 6.19.6 Modulating control

UltraCella can manage a modulating control function using a 0 to 10 V analogue output with direct or reverse action and settable control set point and differential. The control variable is defined by parameter AM1, the control range by parameter rM1.

Par.	Description	Def	Min	Max	UoM
AM1	Modulating control: control variable configuration	3	0	14	-
	0 Sm 8 generic temperature probe 2				
	1 Sd1 9 generic temperature probe 3				
	2 Sr 10 generic temperature probe 4				
	3 Sv 11 generic temperature probe 5				
	4 Sd2 12 generic humidity probe 4				
	5 Sc 13 generic humidity probe 5				
	6 SA 14 generic pressure probe 5				
	7 Su				
r1M	Modulating control: mode 0/1=direct/reverse	0	0	1	-
SM1	Modulating control: set point	0,0	-50,0 0,0 -20,0	200,0 100,0 999	°C/°F/ rH%/ bar/ psi
rc1	Modulating control: differential	2,0	0,1	20,0	°C/°F/ rH%/ bar/ psi

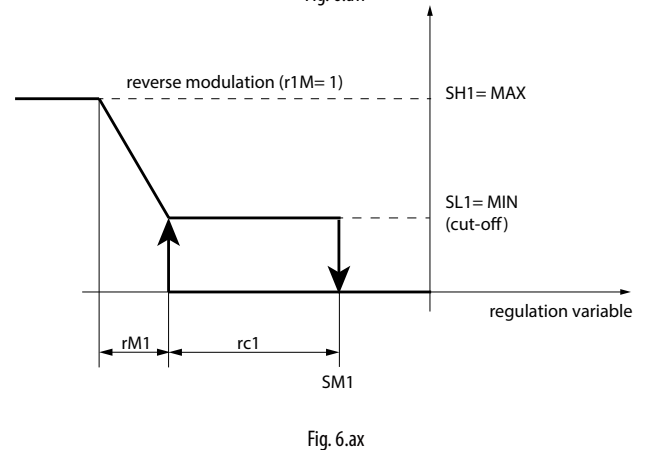
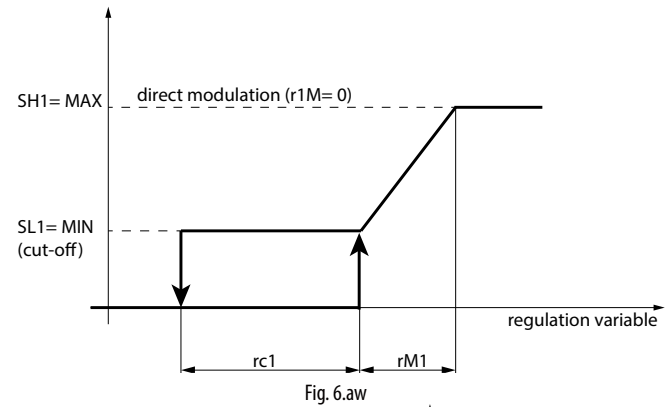
Par.	Description	Def	Min	Max	UoM
rM1	Modulating control: modulation range, between min SL1 and max SH1	2,0	0,1	40,0	°C/°F/ rH%/ bar/ psi

The maximum and minimum values can be set using parameters SH1 and SL1 (cut-off), as a percentage of the range from 0 to 10 V..

Par.	Description	Def	Min	Max	UoM
SL1	Modulating control: min. modulating output value (cut-off)	0,0	0,0	SH1	%
SH1	Modulating control: max. modulating output value	100,0	SL1	100,0	%

To enable the function, set AM1 to a value greater than 0. To use the 0 to 10 V analogue output Y1 for the generic modulating function, set parameter HO1.

Par.	Description	Def	Min	Max	UoM
HO1	Configuration of output Y1 1 = modulating output 1 (generic function)	0	0	3	-



Also for modulating control, two alarm absolute thresholds and an alarm notification delay can be set.

Par.	Description	Def	Min	Max	UoM
AL3	Modulating control: absolute low alarm threshold	0,0	-50,0 0,0 -20,0	200,0 100,0 999	°C/°F/ rH%/ bar/psi
AH3	Modulating control: absolute high alarm threshold	0,0	-50,0 0,0 -20,0	200,0 100,0 999	°C/°F/ rH%/ bar/psi
Ad3	Modulating control: alarm delay	0	0	250	min

The following alarms are generated by the functions:

- GL3: alarm when exceeding low threshold AL3
- GH3: alarm when exceeding high threshold AH3



Example: 0 to 10 V modulating control based on pressure (input B5, 4 to 20 mA) with direct action, control set point 10 bars, differential 1 bar, modulation range 8 bars, minimum output 2 V, maximum output 8 V.

Set:

- /P5 = 0 -> input B5 to 4 to 20 mA
- /A5 = 4 -> generic pressure probe 5
- AM1 = 14 -> generic pressure probe 5
- r1M = 0 -> direct action
- SM1 = 10 -> control set point 10 bars
- rc1 = 1 -> differential 1 bar
- rM1 = 8 -> modulation range 8 bars
- SL1 = 20,0 -> minimum output 2 V
- SH1 = 80,0 -> maximum output 8 V
- HO1 = 1 -> 0 to 10 V output Y1 for generic modulating function

### 6.19.7 Generic alarms

UltraCella can manage up to two generic alarms, associated with alarms that are already featured (for example CHT, high condenser temperature alarm, or LP, low pressure alarm), or to digital inputs D12/DI3, which therefore need to be specifically configured. The source of the alarm is defined by parameter AA1 (AA2), the notification delay by parameter Ad4 (Ad5).

If the generic alarm is associated with digital input DI2 (for AA1) or DI3 (for AA2), the operating logic can be selected (normally open/normally closed):

- r1A (r2A) = 0 -> N.O. logic -> alarm if DI2 (DI3) is closed (active)
- r1A (r2A) = 1 -> N.C. logic -> alarm if DI2 (DI3) is open (not active)

Par.	Description	Def	Min	Max	UoM
AA1	Alarm 1: select source	0	0	11	-
	0   DI2 (with A5=15)				
	1   Virtual probe (Sv) fault (rE)				
	2   Probe S1 (Sm) fault (E0)				
	3   Probe S2 fault (E1)				
	4   Probe S3 fault (E2)				
	5   Probe S4 fault (E3)				
	6   Probe S5 fault (E4)				
	7   Low pressure alarm (LP)				
	8   Immediate external alarm (IA)				
	9   Low temperature alarm (LO)				
	10   High temperature alarm (HI)				
11   High condenser temperature alarm (CHT)					
r1A	Alarm 1: logic 0/1=normally open/normally closed	0	0	1	-
Ad4	Alarm 1: delay	0	0	250	min
AA2	Alarm 2: select source	0	0	11	-
	0   DI3 (with A9=15)				
	1   Virtual probe (Sv) fault (rE)				
	2   Probe S1 (Sm) fault (E0)				
	3   Probe S2 fault (E1)				
	4   Probe S3 fault (E2)				
	5   Probe S4 fault (E3)				
	6   Probe S5 fault (E4)				
	7   Low pressure alarm (LP)				
	8   Immediate external alarm (IA)				
	9   Low temperature alarm (LO)				
	10   High temperature alarm (HI)				
11   High condenser temperature alarm (CHT)					
r2A	Alarm 2: logic 0/1=normally open/normally closed	0	0	1	-
Ad5	Alarm 2: delay	0	0	250	min

The following alarms are generated by the functions:

- GA1: alarm relating to function AA1
- GA2: alarm relating to function AA2

To associate the generic alarm to a digital input, DI2 or DI3, set parameter A5 or A9.

Par.	Description	Def	Min	Max	UoM
A5	Digital input 2 configuration (DI2) 15 = alarm from generic function	0	0	15	-
A9	Digital input 3 configuration (DI3) 15 = alarm from generic function	0	0	15	-

To use outputs AUX1/AUX2 for the generic alarms, set parameters H1/H5.

Par.	Description	Def	Min	Max	UoM
H1	AUX1 output configuration 10 = generic alarm 1 (GA1) 11 = generic alarm 2 (GA2)	0	0	17	-
H5	AUX2 output configuration 10 = generic alarm 1 (GA1) 11 = generic alarm 2 (GA2)	0	0	17	-

Example: AUX1 active for alarm from digital input DI3 with N.C. logic, delay 15 minutes.

Set:

- AA2 = 0 -> Alarm 2 associated with digital input DI3
- r2A = 1 -> N.C. logic
- Ad5 = 15 -> delay 15 minutes
- A9 = 15 -> DI3 for alarm from generic function
- H1 = 11 -> AUX1 for generic alarm 2

### 6.20 Output configuration

On UltraCella, the functions associated with the 6 physical outputs (relays) can be configured so as to adapt to the needs of most installations.

For example, if the cold room light does not need to be managed from the panel, as it is already managed centrally or by an external control, the corresponding output (relay) R3 can be used for a different function, for example to control heaters in the collection pan.

The configuration is performed in two steps:

1. Configure the generic function corresponding to the output (relay)

Par.	Description	Def	Min	Max	UoM
H15	Output R1 configuration	5	0	7	-
	0   compressor				
	1   defrost				
	2   fan				
	3   light				
	4   AUX1				
	5   AUX2				
	6   AUX3				
H16	Output R2 configuration - see H15	4	0	7	-
H17	Output R3 configuration - see H15	3	0	7	-
H18	Output R4 configuration - see H15	2	0	7	-
H19	Output R5 configuration - see H15	1	0	7	-
H20	Output R6 configuration - see H15	0	0	7	-

2. Configure the specific function corresponding to the output (AUX1-AUX4) selected in the previous step

Par.	Description	Def	Min	Max	UoM
H1	AUX1 output configuration	1	0	21	-
	0   Normally energised alarm				
	1   Normally de-energised alarm				
	2   Activate from AUX button or DI				
	3   Activate collection pan heater				
	4   Auxiliary evaporator defrost				
	5   Pump down valve				
	6   Condenser fan				
	7   Delayed compressor				
	8   Control output 1 ON/OFF				
	9   Control output 2 ON/OFF				
	10   Alarm output 1				
	11   Alarm output 2				
	12   Do not select				
	13   Second compressor step				
14   Second compressor step with rotation					

Par.	Description	Def	Min	Max	UoM
H1	AUX1 output configuration	1	0	21	-
	15 Humidity output				
	16 Reverse mode output				
	17 Output managed by time band				
	18 Control output 3 ON/OFF				
	19 Reverse output - dehumidification				
	20 External dehumidifier				
	21 Reverse mode output 2				
H5	AUX2 output configuration - see H1	1	0	21	-
H13	AUX3 output configuration - see H1	2	0	21	-
H14	AUX4 output configuration - see H1	2	0	21	-

**Note:** the UltraCella relays have different ratings (max current permitted) and some of these are already powered at 230 V: always check the relay's rating and power supply in relation to the load being controlled.

**Note:** if the AUX3 and AUX4 functions are used, their status (function active or inactive) is indicated by the LEDs on the UP and DOWN arrows. The UP and DOWN arrow buttons do not activate the AUX3 and AUX4 functions (unlike in the case of AUX1 and AUX2)

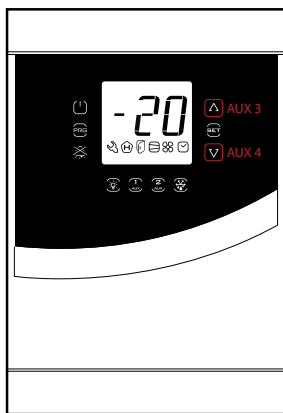


Fig. 6.ay

### 6.20.8 Smooth Lines

The Smooth Lines function requires UltraCella to be connected to an EVD module to control an electronic valve. The purpose is to constantly modulate refrigerant flow to the evaporator so as to keep the temperature inside the cold room as constant as possible and avoid frequent compressor on/off cycles. The result is better product preservation in the cold room and considerable energy savings compared to traditional ON/OFF control.

The following parameters are used:

Par.	Description	Def	Min	Max	UoM
PLt	Stop smooth lines offset	2.0	0.0	10.0	°C/°F
PHS	Maximum smooth lines offset	15.0	0.0	50.0	°C/°F
PSP	Smooth lines proportional coefficient	5.0	0.0	100.0	°C/°F
PSI	Smooth lines integral time	120	0	1200	s
PSd	Smooth lines derivative time	0	0	100	s
PSM	Enable smooth lines (0=NO - 1=YES)	0	0	1	/

To enable the Smooth lines function, access the EVD EVO menu, enable the EVD module and set PSM = 1

The function works as follows:

When the temperature reaches the set point + half of the differential ('ST + rd / 2'), control does not stop, rather a PID algorithm increases the superheat set point in order to modulate the expansion valve opening. This special algorithm works until the temperature exceeds the value 'ST - PLt', when "Smooth lines active" is set to 1.

When the Smooth lines function is active, the algorithm tells the supervisor, if connected, whether UltraCella is operating within a certain margin, in other words, whether the suction pressure set point on the corresponding line can be increased without having a negative impact on control (if the average set point is greater than P3 + THS, calculated inside the time frame FSt)

If the average set point is greater than P3 + TSH, the Smooth Lines status is set to 0, allowing the suction pressure to be increased.

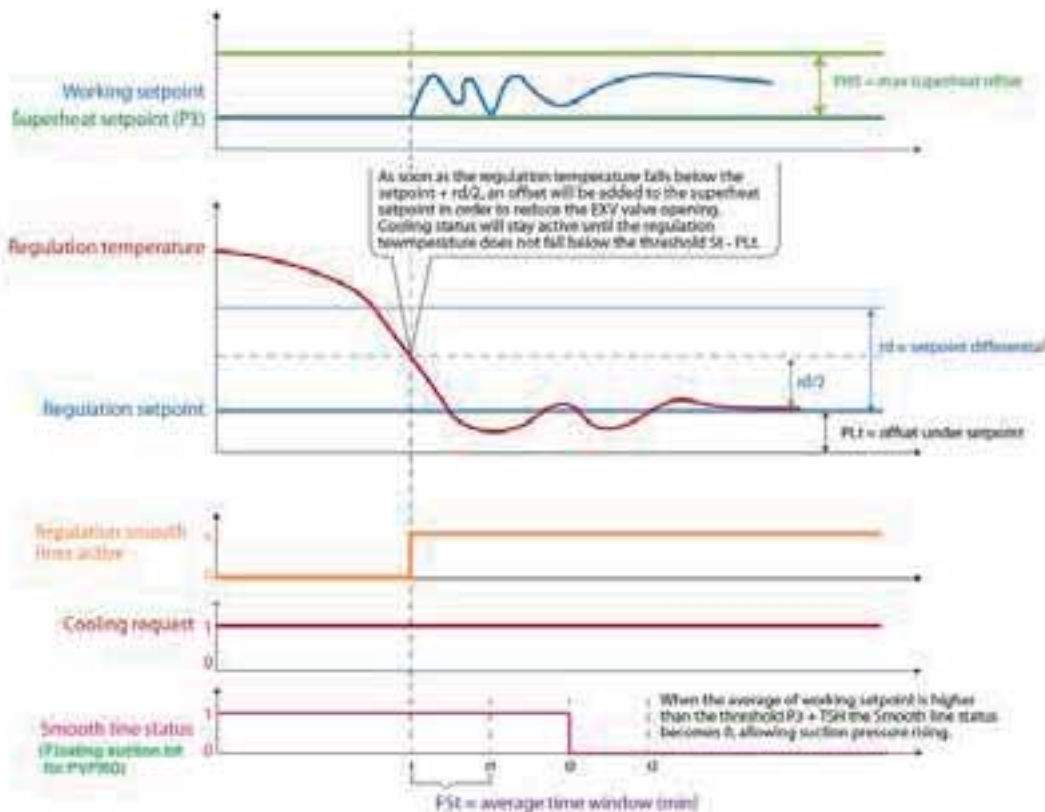


Fig. 6.az



## 7. PARAMETERS TABLE

Type of variable: A = analogue, I = integer, D = digital

Par.	Description	Def	Min	Max	UOM	Type	CAREL SVP	Modbus SVP	R/W	page
<b>Pro</b>										
/21	Probe measurement stability probe 1	4	0	9	-	I	12	51	R/W	37
/22	Probe measurement stability probe 2	4	0	9	-	I	13	52	R/W	37
/23	Probe measurement stability probe 3	4	0	9	-	I	14	53	R/W	37
/24	Probe measurement stability probe 4	4	0	9	-	I	15	54	R/W	37
/25	Probe measurement stability probe 5	4	0	9	-	I	16	55	R/W	37
/4	Virtual probe composition 0 = probe B1 100= probe B2	0	0	100	-	I	17	56	R/W	44
/5t	Temperature unit of measure 0/1 = °C / °F	0	0	1	-	I	18	57	R/W	38
/5P	Pressure unit of measure 0/1 = bar/psi	0	0	1	-	I	19	58	R/W	38
/6	Display decimal point 0/1 = yes/no	0	0	1	-	D	19	8	R/W	38
/t1	Display variable 1	1	0	13	-	I	67	106	R/W	38
	0 None   7 B1									57
	1 Virtual probe (Sv)   8 B2									
	2 Outlet probe (Sm)   9 B3									
	3 Intake probe (Sr)   10 B4									
	4 Defrost probe 1 (Sd1)   11 B5									
	5 Defrost probe 2 (Sd2)   12 Condenser probe (Sc)									
	6 Set point   13 Variable speed condenser fans set point									
/t2	Display variable 2 (*)	6	0	24	-	I	68	107	R/W	38
	0 None   13 Superheat (EVO)									57
	1 Virtual probe (Sv)   14 Valve opening % (EVO)									
	2 Outlet probe (Sm)   15 Valve opening in steps (EVO)									
	3 Intake probe (Sr)   16 Condenser probe (Sc)									
	4 Defrost probe 1 (Sd1)   17 Probe U1 (3ph mod.)									
	5 Defrost probe 2 (Sd2)   18 Probe U2 (3ph mod.)									
	6 Set point   19 Probe U3 (3ph mod.)									
	7 B1   20 Variable condenser speed set point (Y1)									
	8 B2									
	9 B3   21 Superheat (EVDice))									
	10 B4   22 Valve opening % (EVDice)									
	11 B5   23 Valve opening in steps (EVDice)									
	12 rd   24 Humidity set point									
	(*) can be viewed only on UltraCella Service Terminal or on the controller with double row display									
/P	Type B1 to B3	0	0	2	-	I	20	59	R/W	34
	0 NTC Standard range -50T90°C									
	1 NTC extended range 0T150°C									
	2 PT1000									
/A2	B2 configuration	1	0	3	-	I	21	60	R/W	34
	0 Absent									
	1 Defrost probe 1 (Sd1)									
	2 Intake probe (Sr)									
	3 Generic function on probe 2									
/A3	B3 configuration	0	0	5	-	I	22	61	R/W	34
	0 Absent									
	1 Defrost probe 2 (Sd2)									
	2 Condenser probe (Sc)									
	3 Defrost probe 1 (Sd1)									
	4 Ambient temperature probe (SA)									
	5 Generic function on probe 3									
/P4	B4 type	0	0	2	-	I	23	62	R/W	34
	0 NTC Standard range -50T90°C									57
	1 NTC Extended range 0T150°C									
	2 0 to 10 V									
/A4	B4 configuration	0	0	4	-	I	24	63	R/W	34
	0 Absent									57
	1 Ambient temperature probe (SA)									
	2 Humidity probe									
	3 Probe 4 generic temperature									
	4 Probe 4 generic humidity									
/P5	B5 type	0	0	2	-	I	25	64	R/W	34
	0 4 ... 20 mA									57
	1 0 ... 5 Vrat									
	2 0.5 ... 4.5 Vrat									
/A5	B5 configuration	0	0	5	-	I	26	65	R/W	34
	0 Absent									57
	1 Humidity probe									
	2 Probe 5 generic temperature									
	3 Probe 5 generic humidity									
	4 Probe 5 generic pressure									
	5 Scp (Condensing pressure probe)									

Par.	Description	Def	Min	Max	UOM	Type	CAREL SVP	Modbus SVP	R/W	page
/4L	Probe 4 minimum value	0	-50.0	/4H	-	A	98	208	R/W	34
/4H	Probe 4 maximum value	100	/4L	200	-	A	99	209	R/W	34
/5L	Probe 5 minimum value	0	-50.0	/5H	-	A	100	210	R/W	34
/5H	Probe 5 maximum value	100	/5L	999	-	A	101	211	R/W	34
/C1	Offset B1	0	-20.0	20.0	°C/°F	A	7	0	R/W	34
/C2	Offset B2	0	-20.0	20.0	°C/°F	A	8	1	R/W	34
/C3	Offset B3	0	-20.0	20.0	°C/°F	A	9	2	R/W	34
/C4	Offset B4	0	-20.0	20.0	°C/°F/ %rH	A	10	3	R/W	34
/C5	Offset B5	0	-20.0	20.0	°C/°F/ %rH/ bar/psi	A	11	4	R/W	34

CtL

St	Set point	0	r1	r2	°C/°F	A	12	5	R/W	44
rd	Differential	2.0	0.1	20	°C/°F	A	13	6	R/W	44
r1	Minimum set point	-50.0	-50.0	r2	°C/°F	A	14	7	R/W	44
r2	Maximum set point	60.0	r1	200	°C/°F	A	15	8	R/W	44
r3	Operating mode	0	0	1	-	D	11	0	R/W	44
	0   direct with defrost									
	1   direct without defrost									
rn	Dead band	0	0	60	°C/°F	A	80	190	R/W	55
rr	Differential for control with dead band	2.0	0.1	20	°C/°F	A	81	191	R/W	55
r4	Offset set point	3	60	60	°C/°F	A	82	192	R/W	45
StH	Humidity set point	90.0	0.0	100.0	%rH	A	28	19	R/W	58
rdH	Humidity differential	5.0	0.1	20.0	%rH	A	29	20	R/W	58
PS1	Ramps: final set point, phase 1	0	-50.0	200.0	°C/°F	A	77	187	R/W	45
PS2	Ramps: final set point, phase 2	0	-50.0	200.0	°C/°F	A	78	188	R/W	45
PS3	Ramps: final set point, phase 3	-30.0	-50.0	-200.0	-	A	79	189	R/W	45
PH1	Ramps: duration of phase 1	6	0	10	days	A	102	212	R/W	45
PH2	Ramps: duration of phase 2	2	0	10	days	A	103	213	R/W	45
PH3	Ramps: duration of phase 3	10	0	10	days	A	104	214	R/W	45
Pdt	Ramps: maximum set point variation after blackout	20.0	10.0	30.0	°C/°F	A	106	216	R/W	46
Pon	Enable set point ramps	0	0	1	-	D	159	48	R/W	46
	0/1 = ramps disabled/enabled									

CMP

c0	Compressors/fan start delay at power on	0	0	15	min	I	31	70	R/W	43
c1	Minimum time between compressor starts	6	0	30	min	I	32	71	R/W	37
c2	Minimum compressor off time	3	0	15	min	I	33	72	R/W	37
c3	Minimum compressor on time	3	0	15	min	I	34	73	R/W	37
c4	Compressor running time in duty setting	0	0	100	min	I	35	74	R/W	53
cc	Continuous cycle duration	0	0	15	hours	I	36	75	R/W	47
c6	Low temperature alarm delay after continuous cycle	2	0	250	hours	I	37	76	R/W	47
c7	Maximum pump down (PD) time	0	0	900	s	I	38	77	R/W	46
	0 = Pump down disabled									
c8	Compressor start delay after opening of pump down valve	5	0	60	s	I	39	78	R/W	46
c9	Autostart in pump down	0	0	1	-	D	13	2	R/W	47
	0/1 = whenever pump down valve closes/ whenever pump down valve closes & every request of low pressure switch without regulation request									
c10	Pump down by time/pressure	0	0	1	-	D	12	1	R/W	47
	0/1 = pressure/ time									
c11	Second compressor start delay	4	0	250	s	I	40	79	R/W	43
FC4	Condenser fan deactivation temperature	40.0	-50.0	200.0	°C/°F	A	16	9	R/W	52
FCH	Variable speed condenser fans: max. output value	100	FCL	100	%	A	131	241	R/W	52
FCL	Variable speed condenser fans: min. output value	0	0	FCH	%	A	132	242	R/W	52
FCn	Variable speed condenser fans: min. capacity %	0	0	FCH	%	A	133	243	R/W	52
FCS	Variable speed condenser fans: set point	15.0	-100.0	200.0	°C/°F	A	134	244	R/W	52
FCd	Variable speed condenser fans: differential	2.0	0.1	10.0	°C/°F	A	135	245	R/W	52
FCt	Variable speed condenser fans: fixed or floating set point	0	0	1	-	D	167	56	R/W	53
	0/1 = FCS fixed/floating									
FSH	Floating condensing temp. set point: max value	25.0	FSL	200.0	°C/°F	A	136	246	R/W	53
FSL	Floating condensing temp. set point: min value	5.0	-100.0	FSH	°C/°F	A	137	247	R/W	53
FSO	Floating condensing temp. set point: offset	5.0	-50.0	50.0	°C/°F	A	138	248	R/W	53

dEF

d0	Type of defrost	0	0	3	-	I	41	80	R/W	36
	0   Heater by temperature									48
	1   Hot gas by temperature									
	2   Heater by time									
	3   Hot gas by time									
dl	Max interval between consecutive defrosts	8	0	250	hours	I	42	81	R/W	49
	0 = defrost not performed									
dt1	End defrost temperature, main evaporator	4.0	-50.0	200.0	°C/°F	A	17	10	R/W	36
										48
dt2	End defrost temperature, auxiliary evaporator	4.0	-50.0	200.0	°C/°F	A	18	11	R/W	48
dP1	Maximum defrost duration	30	1	250	min	I	43	82	R/W	36
										48
dP2	Maximum defrost duration, auxiliary evaporator	30	1	250	min	I	44	83	R/W	45
dd	Dripping time after defrost	2	0	30	min	I	45	84	R/W	36
d3	Defrost activation delay	0	0	250	min	I	46	85	R/W	50

Par.	Description	Def	Min	Max	UOM	Type	CAREL SVP	Modbus SVP	R/W	page
dpr	Defrost priority over continuous cycle 0/1 = no/yes	0	0	1	-	D	15	4	R/W	50
d4	Defrost at start-up 0/1=no/yes	0	0	1	-	D	14	3	R/W	50
d5	Defrost delay at start-up	0	0	250	min	I	47	86	R/W	50
d6	Terminal display during defrost	1	0	2	-	I	49	88	R/W	48
	0   Temperature alternated with dEF									
	1   Last temperature shown before defrost									
2   dEF										25
d8	High temperature alarm delay after defrost (and door open)	1	0	250	hours	I	48	87	R/W	50
d13	Defrost on two evaporators (0=Simultaneous - 1=Separate)	0	0	1	/	D	193	63	R/W	36
	56									

ALM											
A0	Alarm and fan differential	2.0	0.1	20.0	°C/°F	A	19	12	R/W	52 73	
A1	Alarm thresholds (AL, AH) relative to set point or absolute 0/1=relative/absolute	0	0	1	-	D	16	5	R/W	73	
AL	Low temperature alarm threshold If A1=0, AL=0: alarm disabled If A1=1, AL=-50: alarm disabled	0.0	-50.0	200.0	°C/°F	A	20	13	R/W	73	
AH	High temperature alarm threshold If A1=0, AH=0: alarm disabled If A1=1, AH=200: alarm disabled	0.0	-50.0	200.0	°C/°F	A	21	14	R/W	73	
Ad	High/low temperature alarm delay	120	0	250	min	I	50	89	R/W	73	
A5	Digital input 2 (DI2) configuration	0	0	17	-	I	51	90	R/W	35 45 47 58 60	
	0   Inactive										9   Do not select
	1   Immediate external alarm										10   Do not select
	2   Do not select										11   Do not select
	3   Enable defrost										12   Activate AUX
	4   Start defrost										13   Do not select
	5   Door switch (enable A3)										14   Activate continuous cycle
	6   Remote ON/OFF										15   Alarm from generic function
	7   Change set point										16   Start/stop defrost
8   Low pressure switch	17   Serious alarm										
A6	Stop compressor on external alarm	0	0	100	min	I	53	92	R/W	73	
A7	Low pressure (LP) alarm delay	1	0	250	min	I	54	93	R/W	36	
A8	Enable Ed1 and Ed2 alarms 0/1= disabled/enabled alarms	0	0	1	-	D	168	57	R/W	48	
A9	Digital input 3 (DI3) configuration	0	0	17	-	I	52	91	R/W	35 45 47 58 60	
	0   Inactive										9   Do not select
	1   Immediate external alarm										10   Do not select
	2   Do not select										11   Do not select
	3   Enable defrost										12   Activate AUX
	4   Start defrost										13   Do not select
	5   Door switch (enable A3)										14   Activate continuous cycle
	6   Remote ON/OFF										15   Alarm from generic function
	7   Change set point										16   Start/stop defrost
8   Low pressure switch	17   Serious alarm										
A10	Low pressure alarm delay (LP), compressor running	3	0	60	min	I	55	94	R/W		
Ac	High temperature condenser alarm threshold	70.0	-50.0	200.0	°C/°F	A	22	15	R/W	74	
Acd	High temperature condenser alarm delay	0	0	250	min	I	56	95	R/W	74	
ULL	Absolute low humidity alarm threshold 0= alarm disabled	0	0	100.0	%rH	A	84	194	R/W	73	
UHL	Absolute high humidity alarm threshold 100= alarm disabled	100.0	0	100.0	%rH	A	83	193	R/W	73	
AdH	Humidity alarms AUH, AUL delay	120	0	250	min	A	117	227	R/W	73	
A11	Digital input 1 configuration (DI1)	5	0	17	/	A	176	279	R/W	34 35	
	0   Inactive										9   Do not select
	1   Immediate external alarm										10   Do not select
	2   Do not select										11   Do not select
	3   Enable defrost										12   Activate AUX
	4   Start defrost										13   Do not select
	5   Door switch (enable A3)										14   Activate continuous cycle
	6   Remote ON/OFF										15   Alarm from generic function
	7   Change set point										16   Start/stop defrost
8   Low pressure switch	17   Serious alarm										

Fan											
F0	Evaporator fan management	0	0	2	-	I	174	265	R/W	50 51	
	0   (ON-OFF) always on with compressor on										4   (ON-OFF) always on
	1   (ON-OFF) activation based on Sd, Sv										5   (ON-OFF) activation with temp. / humidity control
	2   (MODULATING) variabile speed based on Sd										6   (MODULATING) variabile speed fas based on Sd-Sv
3   (ON-OFF) activation based on Sd	7   (MODULATING) variabile speed fans based on Sv										
F1	Fan activation temperature	5.0	-50.0	200.0	°C/°F	A	23	16	R/W	50	
Frd	Fan activation differential	2.0	0.1	20.0	°C/°F	A	24	17	R/W	50	

Par.	Description	Def	Min	Max	UOM	Type	CAREL SVP	Modbus SVP	R/W	page
F2	Fan activation time with compressor off	30	0	60	min	I	57	96	R/W	50 51
F3	Evaporator fan during defrost 0/1= ON/OFF	1	0	1	-	D	17	6	R/W	36
Fd	Post dripping time	1	0	30	min	I	60	99	R/W	36
F4	Humidity output during defrost 0/1 = ON/OFF	1	0	1	-	D	71	28	R/W	51 58
F5	Evaporator fans cut-off temperature (hysteresis 1°C)	15	-50	200	°C/°F	A	25	18	R/W	51
F6	Maximum fan speed	100	F7	100	%	I	58	97	R/W	51
F7	Minimum fan speed	0	0	F6	%	I	59	98	R/W	51
F8	Fans peak time 0 = disabled function	0	0	240	s	I	176	175	R/W	51
F10	Evaporator fans forcing time at maximum speed 0 = disabled function	0	0	240	min	I	177	176	R/W	51

CnF

H0	Serial address	193	0	247	-	I	69	108	R	38
In	Type of unit	0	0	0	-	-	-	-	R	
H1	AUX1 output configuration	1	0	21	-	I	61	100	R/W	38
	0 Normally energised alarm	11	Alarm output 2							43
	1 Normally de-energised alarm	12	Do not select							46
	2 Activate from AUX button or DI	13	Second compressor step							52
	3 Activate collection pan heater	14	Second compressor step with rotation							53
	4 Auxiliary evaporator defrost	15	Humidity output							54
	5 Pump down valve	16	Reverse mode output							55
	6 Condenser fan	17	Output managed by time band							56
	7 Delayed compressor	18	Control output 3 ON/OFF							58
	8 Control output 1 ON/OFF	19	Reverse output - dehumidification							59
	9 Control output 2 ON/OFF	20	External dehumidifier							61
	10 Alarm output 1	21	Reverse mode output 2							
H4	Buzzer 0/1 = enabled/ disabled	0	0	1	-	D	21	10	R/W	38
H5	AUX2 output configuration	1	0	21	-	I	62	101	R/W	38
	0 Normally energised alarm	11	Alarm output 2							43
	1 Normally de-energised alarm	12	Do not select							46
	2 Activate from AUX button or DI	13	Second compressor step							52
	3 Activate collection pan heater	14	Second compressor step with rotation							53
	4 Auxiliary evaporator defrost	15	Humidity output							54
	5 Pump down valve	16	Reverse mode output							55
	6 Condenser fan	17	Output managed by time band							56
	7 Delayed compressor	18	Control output 3 ON/OFF							58
	8 Control output 1 ON/OFF	19	Reverse output - dehumidification							59
	9 Control output 2 ON/OFF	20	External dehumidifier							61
	10 Alarm output 1	21	Reverse mode output 2							
H6	Terminal keys block configuration	0	0	255	-	I	70	109	R/W	38
	0 all keys enabled									
	1 Set point modification									
	2 Defrost									
	4 -									
	8 AUX1 output									
	16 PRG+SET (menu)									
	32 AUX2 output									
	64 ON/OFF management									
	128 Light management									
	255 all keys disabled									
HO1	Output Y1 configuration	0	0	3	-	I	63	102	R/W	43
	0 Not active									51
	1 Modulating output 1 (generic function)									52
	2 Variable speed evaporator fans set on Sd probe									60
	3 Variable speed condenser fans									
H7	BMS protocol selection 0= Carel 1= Modbus	0	0	1	-	I	188	180	R/W	18 38
H10	BMS baud rate bit/s	4	0	9	-	A	165	266	R/W	18
	0 1200	5	38400							
	1 2400	6	57600							
	2 4800	7	76800							
	3 9600	8	115200							
	4 19200	9	375000							
H11	BMS stop bits	2	1	2	-	A	166	267	R/W	18
	1 1 bit di stop									
	2 2 di bit di stop									
H12	BMS parity	0	0	2	-	A	167	268	R/W	18
	1 odd									
	2 even									

Par.	Description	Def	Min	Max	UOM	Type	CAREL SVP	Modbus SVP	R/W	page
tr1	First temperature to be recorded	0	0	8	-	I	189	181	R/W	29
	0 No log	5				Sd2				
	1 Sv	6				Sc				
	2 Sm	7				SA				
	3 Sr	8				Su				
4 Sd1										
tr2	Second temperature to be recorded	0	0	8	-	I	190	182	R/W	29
	0 No log	5				Sd2				
	1 Sv	6				Sc				
	2 Sm	7				SA				
	3 Sr	8				Su				
4 Sd1										
trc H13	Sample time temperature recording	5	2	60	min	I	191	183	R/W	29
	AUX3 output configuration	2	0	21	/	A	168	271	R/W	62-64
	0 Normally energised alarm	11				Alarm output 2				
	1 Normally de-energised alarm	12				Do not select				
	2 Cannot be selected	13				Second compressor step				
	3 Activate collection pan heater	14				Second compressor step with rotation				
	4 Auxiliary evaporator defrost	15				Humidity output				
	5 Pump down valve	16				Reverse mode output				
	6 Condenser fan	17				Output managed by time band				
	7 Delayed compressor	18				Control output 3 ON/OFF				
	8 Control output 1 ON/OFF	19				Reverse output - dehumidification				
9 Control output 2 ON/OFF	20				External dehumidifier					
10 Alarm output 1	21				Reverse mode output 2					
H14	AUX4 output configuration	2	0	21	/	A	169	272	R/W	62-64
	0 Normally energised alarm	11				Alarm output 2				
	1 Normally de-energised alarm	12				Do not select				
	2 Cannot be selected	13				Second compressor step				
	3 Activate collection pan heater	14				Second compressor step with rotation				
	4 Auxiliary evaporator defrost	15				Humidity output				
	5 Pump down valve	16				Reverse mode output				
	6 Condenser fan	17				Output managed by time band				
	7 Delayed compressor	18				Control output 3 ON/OFF				
	8 Control output 1 ON/OFF	19				Reverse output - dehumidification				
	9 Control output 2 ON/OFF	20				External dehumidifier				
10 Alarm output 1	21				Reverse mode output 2					

HcP										
HCE	Enable HACCP 0/1 = No/Yes	0	0	1	-	D	22	11	R/W	74
Htd	HACCP alarm delay	0	0	250	min	I	71	110	R/W	74

rtC										
tcE	Enable data modification	0	0	1	-	D	24	13	R/W	23
tcT	Date/ time change	0	0	1	-	D	25	14	R/W	23
	Action on variation 0→1 o 1→0									
y	Date/ time: year	0	0	37	-	I	98	111	R/W	23
M	Date/ time: month	1	1	12	-	I	99	112	R/W	23
d	Date/ time : day of month	1	1	31	-	I	100	113	R/W	23
h	Date/ time: hour	0	0	23	-	I	101	114	R/W	23
n	Date/ time: minute	0	0	59	-	I	102	115	R/W	23
tcL	Hours/minutes visualization on the second row for models with two rows display 0/1=no/yes	0	0	1	-	D	72	29	R/W	66
ddi	Defrost i (i=1...8): day	0	0	11	days	I	103...110	116...123	R/W	48
hhi	Defrost i (i=1...8): hour	0	0	23	hours	I	111...118	124...131	R/W	48
nni	Defrost i (i=1...8): minute	0	0	59	min	I	119...126	132...139	R/W	48
don	AUX activation by time band: day	0	0	11	days	A	105	215	R/W	56
hon	AUX activation by time band: hours	0	0	23	hours	A	107	217	R/W	56
Mon	AUX activation by time band: minutes	0	0	59	min	A	109	219	R/W	56
hoF	AUX deactivation by time band: hours	0	0	23	hours	A	108	218	R/W	56
MoF	AUX deactivation by time band: minutes	0	0	59	min	A	110	220	R/W	56
H8	Enable AUX activation by time band 0/1=disabled/enabled	0	0	1	-	D	160	49	R/W	56
dSn	Set point variation by time band: day	0	0	11	days	A	111	221	R/W	45
hSn	Start set point variation by time band: hours	0	0	23	hours	A	113	223	R/W	45
MSn	Start set point variation by time band: minutes	0	0	59	min	A	115	225	R/W	45
hSF	End set point variation by time band: hours	0	0	23	hours	A	114	224	R/W	45
MSF	End set point variation by time band: minutes	0	0	59	min	A	116	226	R/W	45
H9	Enable set point variation by time band 0/1=disabled/enabled	0	0	1	-	D	161	50	R/W	45

dol										
c12	Compressor safety time for door switch 0 = disable door management	5	0	5	min	I	64	103	R/W	36
d8d	Compressor restart time for door switch	30	c12	240	min	I	65	104	R/W	36
A3	Disable door microswitch	1	0	1	-	D	138	45	R/W	35
	0 = door microswitch enabled 1 = door microswitch disabled									

Par.	Description	Def	Min	Max	UOM	Type	CAREL SVP	Modbus SVP	R/W	page
tLi	Light on with door open	120	0	240	min	I	66	105	R/W	37
A4	Light management 0 = door switch + light key - 1 = light key	0	0	1	-	D	18	7	R/W	37

rcP (see chapter 3 the procedure for setting parameters to default values)

GEF

AS1	ON/OFF control 1: control variable configuration	3	0	14	-	A	119	229	R/W	58
	0 Sm 8 probe 2 generic temperature									
	1 Sd1 9 probe 3 generic temperature									
	2 Sr 10 probe 4 generic temperature									
	3 Sv 11 probe 5 generic temperature									
	4 Sd2 12 probe 4 generic humidity									
	5 Sc 13 probe 5 generic humidity									
	6 SA 14 probe 5 generic pressure									
	7 Su									
r1S	ON/OFF control 1: mode 0/1=direct/reverse	0	0	1	-	D	162	51	R/W	58
SS1	ON/OFF control 1: set point	0.0	-50.0 0.0 -200.0	200.0 100.0 999	°C/°F/ rH%/ bar/psi	A	85	195	R/W	58
rS1	ON/OFF control 1: differential	2.0	0.1	20.0	°C/°F/ rH%/ bar/psi	A	87	197	R/W	58
AL1	ON/OFF control 1: absolute low alarm threshold	0.0	-50.0 0.0 -200.0	200.0 100.0 999	°C/°F/ rH%/ bar/psi	A	89	199	R/W	59
AH1	ON/OFF control 1: absolute high alarm threshold	0.0	-50.0 0.0 -200.0	200.0 100.0 999	°C/°F/ rH%/ bar/psi	A	91	201	R/W	59
Ad1	ON/OFF control 1: alarm delay	0	0	250	min	A	121	231	R/W	59
AS2	ON/OFF control 2: control variable configuration	3	0	14	-	A	120	230	R/W	58
	0 Sm 8 probe 2 generic temperature									
	1 Sd1 9 probe 3 generic temperature									
	2 Sr 10 probe 4 generic temperature									
	3 Sv 11 probe 5 generic temperature									
	4 Sd2 12 probe 4 generic humidity									
	5 Sc 13 probe 5 generic humidity									
	6 SA 14 probe 5 generic pressure									
	7 Su									
r2S	ON/OFF control 2: mode 0/1=direct/reverse	0	0	1	-	D	163	52	R/W	58
SS2	ON/OFF control 2: set point	0.0	-50.0 0.0 -200.0	200.0 100.0 999	°C/°F/ rH%/ bar/psi	A	86	196	R/W	58
rS2	ON/OFF control 2: differential	2.0	0.1	20.0	°C/°F/ rH%/ bar/psi	A	88	198	R/W	58
AL2	ON/OFF control 2: absolute low alarm threshold	0.0	-50.0 0.0 -200.0	200.0 100.0 999	°C/°F/ rH%/ bar/psi	A	90	200	R/W	59
AH2	ON/OFF control 2: absolute high alarm threshold	0.0	-50.0 0.0 -200.0	200.0 100.0 999	°C/°F/ rH%/ bar/psi	A	92	202	R/W	59
Ad2	ON/OFF control 2: alarm delay	0	0	250	min	A	122	232	R/W	59
AS3	ON/OFF control 3: control variable configuration	3	0	14	-	A	119	229	R/W	58
	0 Sm 8 probe 2 generic temperature									
	1 Sd1 9 probe 3 generic temperature									
	2 Sr 10 probe 4 generic temperature									
	3 Sv 11 probe 5 generic temperature									
	4 Sd2 12 probe 4 generic humidity									
	5 Sc 13 probe 5 generic humidity									
	6 SA 14 probe 5 generic pressure									
	7 Su									
r3S	ON/OFF control 3: mode (0/1= direct/reverse)	0	0	1	-	D	162	51	R/W	58
SS3	ON/OFF control 3: set point	0.0	-50.0 0.0 -200.0	200.0 100.0 999	°C/°F/ rH%/ bar/psi	A	85	195	R/W	58
rS3	ON/OFF control 3: differential	2.0	0.1	20.0	°C/°F/ rH%/ bar/psi	A	87	197	R/W	58
AL6	ON/OFF control 3: absolute low alarm threshold	0.0	-50.0 0.0 -200.0	200.0 100.0 999	°C/°F/ rH%/ bar/psi	A	89	199	R/W	59
AH6	ON/OFF control 3: absolute high alarm threshold	0.0	-50.0 0.0 -200.0	200.0 100.0 999	°C/°F/ rH%/ bar/psi	A	91	201	R/W	59
Ad6	ON/OFF control 3: alarm delay	0	0	250	min	A	121	231	R/W	59

Par.	Description	Def	Min	Max	UOM	Type	CAREL SVP	Modbus SVP	R/W	page
AM1	Modulating control: control variable configuration	3	0	14	-	A	123	233	R/W	59
	0   Sm   8   probe 2 generic temperature									
	1   Sd1   9   probe 3 generic temperature									
	2   Sr   10   probe 4 generic temperature									
	3   Sv   11   probe 5 generic temperature									
	4   Sd2   12   probe 4 generic humidity									
	5   Sc   13   probe 5 generic humidity									
	6   SA   14   probe 5 generic pressure									
	7   Su									
r1M	Modulating control: mode 0/1=direct/reverse	0	0	1	-	D	164	53	R/W	59
SM1	Modulating control: set point	0.0	-50.0 0.0 -200.0	200.0 100.0 999	°C/°F/ rH%/ bar/psi	A	93	203	R/W	59
rc1	Modulating control: differential	2.0	0.1	20.0	°C/°F/ rH%/ bar/psi	A	94	204	R/W	59
rM1	Modulating control: modulation range, between min SL1 and max SH1	2.0	0.1	40.0	°C/°F/ rH%/ bar/psi	A	95	205	R/W	59
SL1	Modulating control: min. modulating output value (cut-off)	0.0	0.0	SH1	%	A	125	235	R/W	59
SH1	Modulating control: max. modulating output value	100.0	SL1	100.0	%	A	124	234	R/W	59
AL3	Modulating control: absolute low alarm threshold	0.0	-50.0 0.0 -200.0	200.0 100.0 999	°C/°F/ rH%/ bar/psi	A	96	206	R/W	60
AH3	Modulating control: absolute high alarm threshold	0.0	-50.0 0.0 -200.0	200.0 100.0 999	°C/°F/ rH%/ bar/psi	A	97	207	R/W	60
Ad3	Modulating control: alarm delay	0	0	250	min	A	126	236	R/W	60
AA1	Alarm 1: select source	0	0	11	-	A	127	237	R/W	60
	0   DI2 (with A5=15)   6   Probe S5 fault (E4)									
	1   Virtual probe (Sv) fault (rE)   7   Low pressure alarm (LP)									
	2   Probe S1 (Sm) fault (E0)   8   Immediate external alarm (IA)									
	3   Probe S2 fault (E1)   9   Low temperature alarm (LO)									
	4   Probe S3 fault (E2)   10   High temperature alarm (HI)									
	5   Probe S4 fault (E3)   11   High condenser temperature alarm (CHT)									
r1A	Alarm 1: logic 0/1=normally open/normally closed	0	0	1	-	D	165	54	R/W	60
Ad4	Alarm 1: delay	0	0	250	min	A	129	239	R/W	60
AA2	Alarm 2: select source	0	0	11	-	A	128	238	R/W	60
	0   DI3 (with A9=15)   6   Probe S5 fault (E4)									
	1   Virtual probe (Sv) fault (rE)   7   Low pressure alarm (LP)									
	2   Probe S1 (Sm) fault (E0)   8   Immediate external alarm (IA)									
	3   Probe S2 fault (E1)   9   Low temperature alarm (LO)									
	4   Probe S3 fault (E2)   10   High temperature alarm (HI)									
	5   Probe S4 fault (E3)   11   High condenser temperature alarm (CHT)									
r2A	Alarm 2: logic 0/1=normally open/normally closed	0	0	1	-	D	166	55	R/W	60
Ad5	Alarm 2: delay	0	0	250	min	A	130	240	R/W	60

EVO

P1	Enable communication with EVD EVO module 0/1=no/yes	0	0	1	-	D	70	27	R/W	39
P1t	S1 probe type	0	0	3	-	I	139	150	R/W	39
	0   RAZ. 0 to 5 V   2   4 to 20 mA remote									
	1   4 to 20 mA   3   4 to 20 mA external									
P1M	Max value of S1 probe	12.8	-20	200	°C/°F	A	31	22	R/W	39
P1n	Min value of S1 probe	-1	-20	200	°C/°F	A	30	21	R/W	39
PVt	Valve type	1	1	22	-	I	136	147	R/W	39
	1   CAREL EXV   12   Sporlan seh 100									
	2   Alco ex4   13   Sporlan seh 175									
	3   Alco ex5   14   Danfoss ets 12.5 - 25b									
	4   Alco ex6   15   Danfoss ets 50b									
	5   Alco ex7   16   Danfoss ets 100b									
	6   Alco ex8 330hz CAREL recommended   17   Danfoss ets 250									
	7   Alco ex8 500hz Alco specification   18   Danfoss ets 400									
	8   Sporlan sei 0.5-11   19   2 CAREL EXV connected together									
	9   Sporlan ser 1.5-20   20   Sporlan ser(i) g, j, k									
	10   Sporlan sei 30   21   Danfoss ccm 10-20-30									
	11   Sporlan sei 50   22   Danfoss ccm 40									
PH	Refrigerant type	3	1	40	-	I	135	146	R/W	39
	1   R22   9   R600A   17   R422A   25   HTR02   33   R448A									
	2   R134a   10   R717   18   R423A   26   R23   34   R449A									
	3   R404A   11   R744   19   R407A   27   R1234yf   35   R450A									
	4   R407C   12   R728   20   R427A   28   R1234ze   36   R452A									
	5   R410A   13   R1270   21   R245FA   29   R455A   37   R508B									
	6   R507A   14   R417A   22   R407F   30   R170   38   R452B									
	7   R290   15   R422D   23   R32   31   R442A   39   R513A									
	8   R600   16   R413A   24   HTR01   32   R447A   40   R454B									



Par.	Description	Def	Min	Max	UOM	Type	CAREL SVP	Modbus SVP	R/W	page
PrE	Main regulation type	2	1	4	-	I	137	148	R/W	39
	1   centralized cabinet cold room	3	perturbed cabinet cold room							
	2   self contained cabinet cold room	4	subcritical CO <sub>2</sub> cabinet/cold room							
P0	EVD Modbus address	198	1	247	-	I	134	145	R/W	39
P3	Superheat setpoint	10	-72	324	K	A	44	35	R/W	39
P4	Proportional gain	15	0	800	-	A	36	27	R/W	39
P5	Integral time	150	0	999	sec	A	148	159	R/W	39
P6	Derivative time	2	0	800	sec	A	37	28	R/W	39
P7	LowSH: threshold low superheat	3	-72	324	K	A	45	36	R/W	39
P8	Low Superheat protection integral time	600	0	800	sec	A	38	29	R/W	39
P9	LowSH: low superheat alarm delay	600	0	999	sec	A	150	161	R/W	39
PL1	LOP: threshold for low temperature of evaporation	-50	-60	200	°C/°F	A	64	41	R/W	39
PL2	LOP: integral time	600	0	800	sec	A	39	30	R/W	39
PL3	LOP: low evaporation temperature alarm delay	600	0	999	sec	A	151	162	R/W	39
PM1	MOP: threshold for low temperature of evaporation	50	-60	200	°C/°F	A	47	38	R/W	39
PM2	MOP: integral time	600	0	800	sec	A	40	31	R/W	39
PM3	MOP: low evaporation temperature alarm delay	10	0	999	sec	I	152	163	R/W	39
CP1	Open valve startup (percentage)	50	0	100	%	A	146	157	R/W	39
Pdd	Post defrost delay, (only for single driver)	10	0	60	min	A	147	158	R/W	39
PSb	Valve position in stand-by	0	0	100	step	A	169	174	R/W	39
PMP	Enable manual positioning	0	0	1	-	D	103	38	R/W	39
PMu	Manual valve positioning	0	0	999	step	I	162	173	R/W	39
Pnr	Reset EVD setting 0 -> 1 Reset all EVD parameters	0	0	1	-	D	139	46	R/W	39
PLt	Stop smooth lines offset	2.0	0.0	10.0	°C/°F	A	183	286	R/W	64
PHS	Maximum smooth lines offset	15.0	0.0	50.0	°C/°F	A	184	287	R/W	64
PSP	Smooth lines proportional coefficient	5.0	0.0	100.0	°C/°F	A	185	288	R/W	64
PSI	Smooth lines integral time	120	0	1200	s	A	186	289	R/W	64
PSd	Smooth lines derivative time	0	0	100	s	A	187	290	R/W	64
PSM	Enable smooth lines (0=NO - 1=YES)	0	0	1	/	D	191	62	R/W	64

ICE

IPE	Enable EVDice communication 0/1 = not enabled/ enabled	0	0	1	-	D	183	59	R/W	39
IrE	1= Multiplexed cabinet/cold room	1	1	6 (2, 3, 4, 5 & 6 mode select. only from UltraCella service pGD)	-	I	196	185	R/W	40
	2= Air-conditioner/chiller with plate heat exchanger									
	3= Air-conditioner/chiller with tube bundle heat exchanger									
	4= Air-conditioner/chiller with finned coil heat exchanger									
	5= Reserved									
	6= Reserved									
IP3	Superheat set point	11	IC1	99	K	A	150	255	R/W	40
PH	1 R22 9 R600A 17 R422A 25 HTR02 33 R448A	3	1	40	-	I	135	146	R/W	40
	2 R134a 10 R717 18 R423A 26 R23 34 R449A									
	3 R404A 11 R744 19 R407A 27 R1234yf 35 R450A									
	4 R407C 12 R728 20 R427A 28 R1234ze 36 R452A									
	5 R410A 13 R1270 21 R245FA 29 R455A 37 R508B									
	6 R507A 14 R417A 22 R407F 30 R170 38 R452B									
	7 R290 15 R422D 23 R32 31 R442A 39 R513A									
	8 R600 16 R413A 24 HTR01 32 R447A 40 R454B									
IS1	S1 probe type	3	1	11	-	I	1	249	R/W	40
	1   1 to 4.2 barg	7	0 to 45 barg							
	2   0.4 to 9.3 barg	8	1 to 12.8 barg							
	3   -1 to 9.3 barg	9	0 to 20.7 barg							
	4   0 to 17.3 barg	10	1.86 to 43.0 barg							
	5   0.85 to 34.2 barg	11	reserved							
	6   0 to 34.5 barg									
ICP	PID: proportional gain	15	0	800	-	A	151	256	R/W	40
Iti	PID: integral time	150	0	999	sec	I	171	252	R/W	40
IC1	LowSH protection: threshold	5	-9	IP3	°C/°F	A	152	257	R/W	40
IC2	LowSH protection: integral time	15	0	800	sec	A	153	258	R/W	40
IC3	LOP protection: threshold	-50	-121	IC5	°C/°F	A	154	259	R/W	40
IC4	LOP protection: integral time	0	0	800	sec	A	155	260	R/W	40
IC5	MOP protection: threshold	50	IC3	392	°C/°F	A	156	261	R/W	40
IC6	MOP protection: integral time	20	0	800	sec	A	157	262	R/W	40
IC7	MOP protection: disable threshold	30	-121	392	°C/°F	A	158	263	R/W	40
IC8	Low suction temperature alarm threshold	-50	-121	392	°C/°F	A	159	264	R/W	40
IIA	Enable operating mode modification 0/1 = enabled/not enabled	0	0	1	-	I	2	250	R/W	40
IU1	Enable manual valve positioning 0/1 = enabled/not enabled	0	0	1	-	D	182	58	R/W	40
IU2	Manual valve position	0	0	999	step	I	128	141	R/W	40
IU3	Valve control steps: 1/2 = 480/960 step	1	1	2	-	I	195	184	R/W	40
IU4	Valve opening at start (evaporator/valve capacity ratio)	50	0	100	%	I	173	254	R/W	40
In1	Serial address	99	1	99	-	I	133	144	R/W	40
ICG	Enable EVDice regulation 0/1 = not enabled/ enabled	0	0	1	-	I	184	60	R/W	39
	IL1	Pressure probe S1: minimum alarm value	-1.0	-121.0	IH1	Bar/Psi	A	203	303	R/W
IH1	Pressure probe S1: maximum alarm value	9.3	IL1	392.0	Bar/Psi	A	204	304	R/W	



Par.	Description	Def	Min	Max	UOM	Type	CAREL SVP	Modbus SVP	R/W	page
<b>Ultra 3PH Module commissioning</b>										
cH1	3PH module serial address	1	1	247	-	I	185	177	R/W	41 42
cH2	3PH module offset serial address	0	0	232	-	I	186	178	R/W	41 42
cH3	Type of three phase module 0 = Evaporator - 1 = Full	0	0	1	-	I	187	179	R/W	41 42
cA1	Sd1 probe connection 0 = in UltraCella - 1 = in 3PH module	0	0	1	-	D	130	40	R/W	41 42
cA2	Sd2 probe connection 0 = in UltraCella - 1 = in 3PH module	0	0	1	-	D	131	41	R/W	41 42
cA3	Sc probe connection (Full module only) 0 = in UltraCella - 1 = in 3PH module	0	0	1	-	D	132	42	R/W	41 42
cEn	Enable 3PH mod. 0 = disable - 1 = enable	0	0	1	-	D	133	43	R/W	41 42

<b>Out</b>										
H15	Output R1 configuration	5	0	7	/	A	170	273	R/W	63
	0 Compressor	4	AUX 1							
	1 Defrost	5	AUX 2							
	2 Fan	6	AUX 3							
H16	Output R2 configuration	4	0	7	/	A	171	274	R/W	63
	0 Compressor	4	AUX 1							
	1 Defrost	5	AUX 2							
	2 Fan	6	AUX 3							
H17	Output R3 configuration	3	0	7	/	A	172	275	R/W	63
	0 Compressor	4	AUX 1							
	1 Defrost	5	AUX 2							
	2 Fan	6	AUX 3							
H18	Output R4 configuration	2	0	7	/	A	173	276	R/W	63
	0 Compressor	4	AUX 1							
	1 Defrost	5	AUX 2							
	2 Fan	6	AUX 3							
H19	Output R5 configuration	1	0	7	/	A	174	277	R/W	63
	0 Compressor	4	AUX 1							
	1 Defrost	5	AUX 2							
	2 Fan	6	AUX 3							
H20	Output R6 configuration	0	0	7	/	A	175	278	R/W	63
	0 Compressor	4	AUX 1							
	1 Defrost	5	AUX 2							
	2 Fan	6	AUX 3							

<b>HUM</b>										
StH	Humidity set point	90.0	0.0	100.0	%rH	A	28	19	R/W	58
rdH	Humidity differential	5.0	0.1	20.0	%rH	A	29	20	R/W	58
rrH	Dehumidification differential	5.0	0.0	50.0	%	A	195	298	R/W	60
rnH	Humidity dead band	5.0	0.0	50.0	%	A	196	299	R/W	60
TLL	Minimum temperature to enable humidity control	0.0	-60.0	60.0	°C/°F	A	192	295	R/W	60
THL	Maximum temperature to enable humidity control	0.0	-60.0	60.0	°C/°F	A	193	296	R/W	60
TdL	Temperature differential to enable humidity control	0.0	0.0	20.0	°C/°F	A	194	297	R/W	60
r5	Humidity set point offset	0.0	-50.0	50.0	%	A	199	302	R/W	60
F4	Humidity output during defrost 0/1 = ON/OFF	1	0	1	-	D	71	28	R/W	51 58
U1	Humidity control duty cycle ON time	10	0	120	min	A	197	300	R/W	60
U2	Humidity control duty cycle OFF time	60	0	120	min	A	198	301	R/W	60
F11	Fan speed during humidification	40	0	100	%	A	190	293	R/W	52
F12	Minimum fan speed during humidification	10	0	100	%	A	191	294	R/W	52

<b>HACCP alarms (MULTIFUNCTION MENU)</b>										
HA	Date/time of last HA alarm: day	-	1	7	day	I	72	29	R	69
	Date/time of last HA alarm: hour	-	1	23	hour	I	73	30	R	69
	Date/time of last HA alarm:minute	-	1	59	min	I	74	31	R	69
HA1	Date/time of second last HA alarm: day	-	1	7	day	I	75	32	R	69
	Date/time of second last HA alarm: hour	-	1	23	hour	I	76	33	R	69
	Date/time of second last HA alarm:minute	-	1	59	min	I	77	34	R	69
HA2	Date/time of third last HA alarm: day	-	1	7	day	I	78	35	R	69
	Date/time of third last HA alarm: hour	-	1	23	hour	I	79	36	R	69
	Date/time of third last HA alarm:minute	-	1	59	min	I	80	37	R	69
HAn	Number of HA alarms	-	1	15	-	I	96	53	R	69
HF	Date/time of last HF alarm: day	-	1	7	day	I	81	38	R	69
	Date/time of last HF alarm: hour	-	1	23	hour	I	82	39	R	69
	Date/time of last HF alarm:minute	-	1	59	min	I	83	40	R	69

Par.	Description	Def	Min	Max	UOM	Type	CAREL SVP	Modbus SVP	R/W	page
HF1	Date/time of second last HF alarm: day	-	1	7	day	I	86	43	R	69
	Date/time of second last HF alarm: hour	-	1	23	hour	I	87	44	R	69
	Date/time of second last HF alarm: minute	-	1	59	min	I	88	45	R	69
HF2	Date/time of third last HF alarm: day	-	1	7	day	I	91	48	R	69
	Date/time of third last HF alarm: hour	-	1	23	hour	I	92	49	R	69
	Date/time of third last HF alarm: minute	-	1	59	min	I	93	50	R	69
HF <sub>n</sub>	Number of HF alarms	-	1	15	-	I	97	54	R	69
Hcr	Reset HACCP alarms	0	0	1	-	D	23	12	R/W	69

Tab. 7.a

Variables accessible ONLY via serial connection

Message on the display	Description	Type	Variable type	R/W	CAREL address	Modbus Address
rE	Virtual probe fault alarm	Alarm	D	R	39	17
E0	Probe 1 fault alarm	Alarm	D	R	40	18
E1	Probe 2 fault alarm	Alarm	D	R	41	19
E2	Probe 3 fault alarm	Alarm	D	R	42	20
E3	Probe 4 fault alarm	Alarm	D	R	43	21
E4	Probe 5 fault alarm	Alarm	D	R	44	22
LO	Low temperature alarm	Alarm	D	R	45	23
HI	High temperature alarm	Alarm	D	R	46	24
IA	Immediate external alarm	Alarm	D	R	47	25
dA	Delayed external alarm	Alarm	D	R	48	26
Ed1	Defrost timeout alarm, evaporator 1	Alarm	D	R	50	28
Ed2	Defrost timeout alarm, evaporator 2	Alarm	D	R	51	29
Pd	Pd alarm active	Alarm	D	R	52	30
LP	Low pressure alarm	Alarm	D	R	53	31
Ats	Pump Down autostart alarm	Alarm	D	R	54	32
dor	Door open for too long alarm	Alarm	D	R	55	33
Etc	RTC fault alarm	Alarm	D	R	56	34
EE	Control parameter EEPROM alarm	Alarm	D	R	57	35
EF	Operating parameter EEPROM alarm	Alarm	D	R	58	36
HA	Type HA HACCP alarm	Alarm	D	R	59	37
HF	Type HF HACCP alarm	Alarm	D	R	60	38
CHT	High condenser temperature alarm	Alarm	D	R	62	40
-	Active alarms	Alarm	D	R	63	41
SHA	EVD EVO - Low superheat protection	Alarm	D	R	73	42
LOA	EVD EVO - LOP protection	Alarm	D	R	75	44
MOA	EVD EVO - MOP protection	Alarm	D	R	77	46
EEA	EVD EVO - Valve motor fault	Alarm	D	R	79	48
LSA	EVD EVO - Low suction temperature alarm	Alarm	D	R	81	50
Hit	EVD EVO - High cond. temperature protection activated	Alarm	D	R	83	52
ES1	EVD EVO - Probe S1 fault	Alarm	D	R	84	53
ES2	EVD EVO - Probe S2 fault	Alarm	D	R	85	54
ES3	EVD EVO - Probe S3 EVO fault	Alarm	D	R	86	55
ES4	EVD EVO - Probe S4 alarm	Alarm	D	R	87	56
bAt	EVD EVO - Battery discharged or faulty	Alarm	D	R	88	57
EEE	EVD EVO - Op. and/or parameter EEPROM error	Alarm	D	R	89	58
EIC	EVD EVO - Valve not closed completely	Alarm	D	R	90	59
EEC	EVD EVO - Valve closed in emergency	Alarm	D	R	91	60
EFU	EVD EVO - FW compatibility error (>=5.0)	Alarm	D	R	92	61
ECN	EVD EVO - Configuration error	Alarm	D	R	93	62
ELE	EVD EVO offline	Alarm	D	R	94	63
dnL	Parameter download not successful	Alarm	D	R	115	75
uPd	Parameter upload not successful	Alarm	D	R	116	76
EPE	3PH module offline	Alarm	D	R	119	78
EP0	Probe Sd1 fault 3PH module	Alarm	D	R	120	79
EP1	Probe Sd2 fault auxiliary evap. 3PH module	Alarm	D	R	121	80
EP2	Probe Sc fault 3PH module	Alarm	D	R	122	81
EPn	3PH module configuration error	Alarm	D	R	123	82
EPM	3PH module motor protector alarm	Alarm	D	R	124	83
EPU	High/low pressure alarm or Kriwan activated 3PH module	Alarm	D	R	125	84
LOG	Recorded temperature download not successful	Alarm	D	R	143	94
ALM	Alarm log download not successful	Alarm	D	R	144	95
SOF	UltraCella software update not successful	Alarm	D	R	145	96
IA1	EVD ICE - Probe S1 fault	Alarm	D	R	169	110
IA2	EVD ICE - Probe S2 fault	Alarm	D	R	170	111
IE1	EVD ICE - MOP alarm	Alarm	D	R	171	112
IE2	EVD ICE - LOP alarm	Alarm	D	R	172	113
IE3	EVD ICE - Low superheat alarm	Alarm	D	R	173	114
IE4	EVD ICE - Low pressure alarm	Alarm	D	R	174	115
IE5	EVD ICE - Valve closed in emergency	Alarm	D	R	175	116
IE6	EVD ICE - Control from digital input if offline	Alarm	D	R	176	117
IE7	EVD ICE - Ultracap supplied at low voltage or battery low level	Alarm	D	R	177	118
IE8	EVD ICE - Valve not closed completely	Alarm	D	R	178	119
IEE	EVD ICE - Op. and/or parameter EEPROM error	Alarm	D	R	179	120
ILE	EVD ICE offline	Alarm	D	R	180	121
IEC	EVD ICE - Configuration error	Alarm	D	R	185	123
IEM	EVD ICE - Alignment error with UltraCella	Alarm	D	R	186	124
Y1	0 to 10 V analogue output	Status	A	R	6	5
-	Virtual probe	Status	A	R	26	6
-	Application version	Info	A	R	27	7
-	EVD ICE - Probe S1 value	Status	A	R	58	16
-	EVD ICE - Probe S2 value	Status	A	R	59	17

Message on the display	Description	Type	Variable type	R/W	CAREL address	Modbus Address
-	EVD EVO - Probe S1 value	Status	A	R	60	18
-	EVD EVO - Probe S2 value	Status	A	R	61	19
ESA	EVD EVO - Evaporation temperature	Status	A	R	62	20
-	EVD EVO - Superheat value	Status	A	R	63	21
U1	Probe Sd1 value 3PH module	Status	A	R	65	23
U2	Probe Sd2 value 3PH module	Status	A	R	66	24
U3	Probe Sc value 3PH module	Status	A	R	67	25
-	3PH0 to 10 V analogue output	Status	A	R	68	26
-	First variable shown on LED display	Status	A	R	72	83
-	Second variable shown on LED display	Status	A	R	73	84
-	EVD ICE - Valve position %	Status	A	R	143	98
-	EVD ICE - Superheat	Status	A	R	144	99
ISu	EVD ICE - Suction temperature	Status	A	R	145	100
-	EVD ICE - Evaporation pressure	Status	A	R	146	101
ISa	EVD ICE - Evaporation temperature	Status	A	R	147	102
b1	Probe 1 value	Status	A	R	160	105
b2	Probe 2 value	Status	A	R	161	106
b3	Probe 3 value	Status	A	R	162	107
b4	Probe 4 value	Status	A	R	163	108
b5	Probe 5 value	Status	A	R	164	109
di1	Digital input 1 status (N.C.)	Status	D	R	2	1
di2	Digital input 2 status	Status	D	R	3	2
di3	Digital input 3 status	Status	D	R	4	3
do1	Compressor relay status	Status	D	R	5	4
do2	Defrost relay status	Status	D	R	6	5
do3	Evaporator fan relay status	Status	D	R	7	6
do4	Light relay status	Status	D	R	8	7
do6	AUX 2 relay status	Status	D	R	9	8
do5	AUX 1 relay status	Status	D	R	10	9
-	Controller ON/OFF command	Command	D	R/W	26	15
-	Continuous cycle call command	Command	D	R/W	27	16
-	Defrost call command	Command	D	R/W	28	17
-	LIGHT activation command	Command	D	R/W	29	18
-	AUX1 activation command	Command	D	R/W	30	19
-	AUX2 activation command	Command	D	R/W	31	20
off	OFF	Status	D	R	32	10
cc	Continuous cycle	Status	D	R	33	11
def	Defrost	Status	D	R	34	12
-	Compressor	Status	D	R	38	16
-	Alarm reset	Command	D	R/W	64	21
dU4	3PH digital input 1 status	Status	D	R	127	86
dU5	3PH digital input 2 status	Status	D	R	128	87
-	EVD ICE - Valve position in steps	Status	I	R	168	62
-	EVD EVO - Valve position %	Status	I	R	204	91
-	EVD EVO - Valve position in steps	Status	I	R	205	92
-	EVD EVO - Offset on active SH set (smoothlines)	Status	A	R	200	111
-	EVD EVO - Active SH set (smoothlines)	Status	A	R	201	112
-	EVD EVO - Average SH set (smoothlines)	Status	A	R	203	113
-	EVD EVO - Smooth lines status	Status	D	R	194	129
-	EVD EVO - Cooling request	Status	D	R	195	130
-	EVD EVO - Smooth lines control active	Status	D	R	187	128
-	Compressor 1 status	Status	D	R	196	131
-	Fan status	Status	D	R	197	132
-	Light status	Status	D	R	198	133
-	AUX1 status	Status	D	R	199	134
-	AUX2 status	Status	D	R	200	135
-	AUX3 status	Status	D	R	201	136
-	AUX4 status	Status	D	R	202	137

Tab. 7.b

## 8. SIGNALS AND ALARMS

### 8.1 Signalling

The signals are messages that appear on the display to notify the user regarding the performance of control procedures (such as defrost) or confirmation of controls from keyboard.

Code	Description
---	It appears at controller start-up
---	Probe not enabled

#### Parameters categories

Pro	Probes
CtL	Control
CMP	Compressor
dEF	Defrost
ALM	Alarm
Fan	Fan
CnF	Configuration
HcP	HACCP
rtc	Clock
doL	Door and light
rcP	Recipes
GEF	Generic functions
EVO	EVD EVO module
ICE	EVDice
3PH	Three phases Module 3PH

#### Messages that appear during navigation

PAS	Password
HA	HACCP alarm, HA type
HF	HACCP alarm, HF type
rES	Reset alarms with manual reset Reset HACCP alarms Reset temperature monitoring
cc	Continuous cycle
Ed1	Defrost on evaporator 1 ended by time-out
Ed2	Defrost on evaporator 2 ended by time-out
On	Switch ON
OFF	Switch OFF
AUX	Auxiliary output switch on request
rEc	Temperature registration
no	Operation not executed
uPd	Parameters upload
dnL	Parameters download
bnI	Menu parameters set (bn)
r01...r10	Recipe 1...10
MAX	Maximum temperature read
MIN	Minimum temperature read
Op	Open
cLo	Closed
EXT	Exit menu
Hcr	Reset HACCP alarms
VEr	Software release
LOG	Temperature recorded download
ALG	Alarms recorded download

Tab. 8.a

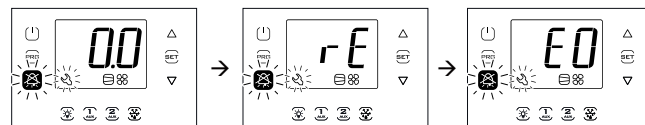
### 8.2 Alarms

There are two types of alarms:

- system alarms: e.g. Eeprom alarms, communication (interrupted) alarms, HACCP, high (HI) and low (LO) temperature alarms, high (AUH) and low (AUL) humidity;
- control alarms: e.g. pump down ended by time-out (Pd), low pressure (LP).

The auxiliary digital outputs AUX1, AUX2 can be configured to signal the alarm status, as normally energised or normally de-energised. See chapter 5. The control indicates the alarms triggered due to faults in the control itself, in the probes or in the network communication. You can also activate an alarm from external contact, immediate type. See chapter 4. On the display the message "IA" appears and at the same time the bell icon blinks and the buzzer activates. If more errors occur, they will appear in sequence on the display.

Example: display after alarms rE and E0.



Note: in order to deactivate the buzzer and the relay alarm press the Alarm key

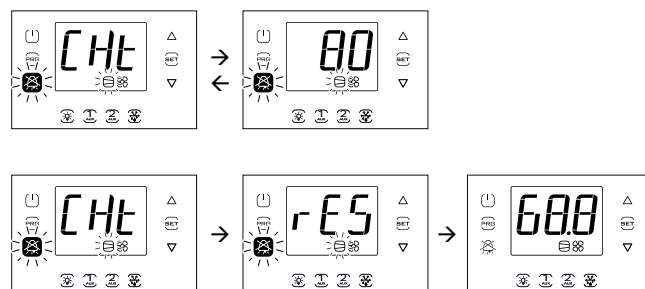
Note: the figures refer to the screens on models with single row display, P/Ns WB0005\*. In models with two rows, P/Ns WB000D\*, the display shows the alarm messages on the second row.

Note: the buzzer is disabled during the wizard on the UltraCella Service terminal.

### 8.3 Reset alarms

Alarms with automatic reset automatically reset when the cause that generated them, for example, after the replacement of a faulty probe, at the end of the alarm for high temperature, etc. For those with manual reset it is necessary to first remove the cause that generated them, and then press the Alarm button for entire restore.

Example: display and manual restore alarm CHt (condenser high temperature)



Note: the figures refer to the screens on models with single row display, P/Ns WB0005\*. In models with two rows, P/Ns WB000D\*, the display shows the alarm messages on the second row

### 8.4 HACCP alarms and display

In order to activate monitoring see par 8.6

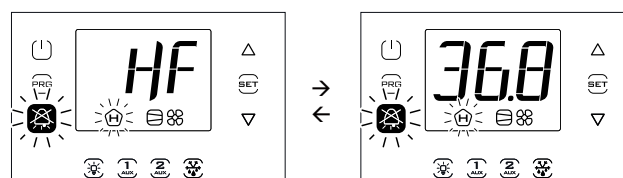
(HACCP = Hazard Analysis and Critical Control Point).

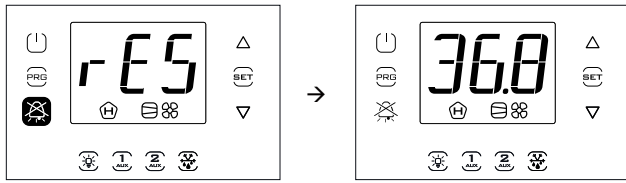
HACCP can only be activated on the controllers with the RTC option fitted, and allows control of the operating temperature and the recording of any anomalies due to power failures or increases in the operating temperature due to various causes (breakages, severe operating conditions, operator errors, etc...). There are two types of HACCP events:

- HA alarms, high temperature during operation;
- HF alarms, high temperature after power black out.

The alarm causes the blinking of HACCP icon, the display of the relative alarm code on the display, storage of the alarm and activation of the buzzer.

Example: display after HF error and restore of the alarm condition:





**Note:** the figures refer to the screens on models with single row display, P/Ns WB0005\*. In models with two rows, P/Ns WB000D\*, the display shows the alarm messages on the second row

**Display and cancel HACCP alarms**

Access the multifunction menu (see chap. 3) and choose HcP. In the multifunction menu you can see the date and time of the last 3 alarms HA and HF. After entering the multifunction menu (see previous par.), select with UP / DOWN the message "HCP".

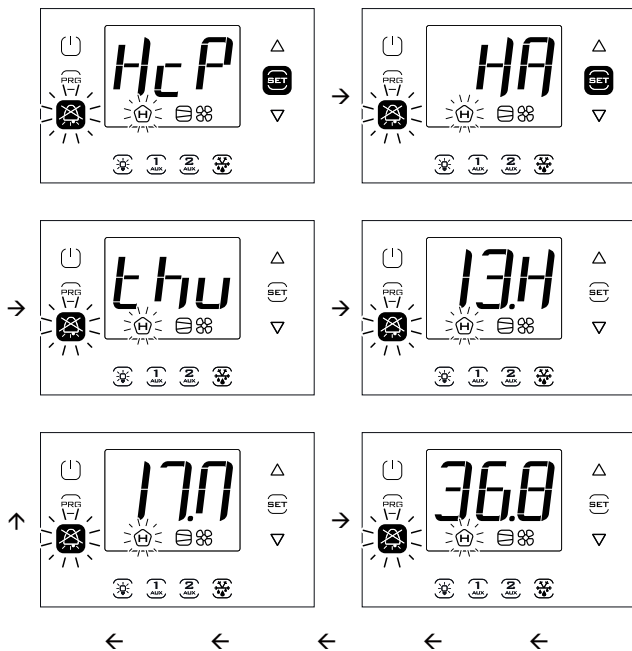
Par.	Description	Def	Min	Max	UoM
HA	Date/time of last HA alarm	0	-	-	-
HA1	Date/time of second last HA alarm	0	-	-	-
HA2	Date/time of third last HA alarm	0	-	-	-
HAn	Number of HA alarms	0	0	15	-
HF	Date/time of last HF alarm	0	-	-	-
HF1	Date/time of second last HF alarm	0	-	-	-
HF2	Date/time of third last HF alarm	0	-	-	-
HFn	Number of HF alarms	0	0	15	-
Hcr	HACCP alarms cancelling	0	0	1	-
	Action on variation 0→1 o 1→0				

Procedure:

1. Press Set and then UP/DOWN to display the parameters of the following table;
2. Press Set to display the alarm date and time;
3. Press Prg until you return to standard display.
4. To cancel all HACCP alarms, change the value of the parameter Hcr

Each alarm is displayed with scrolling text, which contains the day of week, hour, minute, and the temperature that caused the alarm. The buffer in which are saved can contain the data of up to 3 alarms. Once full, the new alarm will replace the oldest one. Instead, the alarm counters (HAn, HFn), after reaching 15, they stop.

**Example:** HA alarm triggered Thursday at 13:17, with detected temperature of 36.8 °C.



**Note:** the figure refers to the screens on models with single row display, P/Ns WB0005\*. In models with two rows, P/Ns WB000D\*, as well as the message indicated, during navigation the display shows the scrolling message "HACCP Alarms" on the second row.

**8.5 EVD EVO alarms**

If an Ultra EVD module, P/N WM00E%, is connected by Fieldbus, UltraCella will be able to signal the following alarms, which only depend on the status of the EVD EVO controller fitted on the module.

Alarm code on display	Alarm description	Button flashing on display	Icon flashing on display	Alarm relay	Buzzer	Reset
SHA	Low superheat protection	✘	-	ON	ON	Automatic
LOA	LOP protection	✘	-	ON	ON	Automatic
MOA	MOP protection	✘	-	ON	ON	Automatic
EEA	Valve motor fault	✘	-	ON	ON	Automatic
LSA	Low suction temperature	✘	-	ON	ON	Automatic
Hit	High condensing temperature protection activated	✘	-	ON	ON	Automatic
ES1	Probe S1 fault or range exceeded alarm	✘	-	ON	ON	Automatic
ES2	Probe S2 fault or range exceeded alarm	✘	-	ON	ON	Automatic
ES3	Probe S3 fault or range exceeded alarm	✘	-	ON	ON	Automatic
ES4	Probe S4 fault or range exceeded alarm	✘	-	ON	ON	Automatic
bAt	Battery discharged or faulty or electrical connection interrupted	✘	-	ON	ON	Automatic
EEE	Operating and/or parameter EEPROM error	✘	-	ON	ON	Automatic
EIC	Valve not closed completely	✘	-	ON	ON	Automatic
EEC	Valve closed in emergency	✘	-	ON	ON	Automatic
EFu	FW compatibility error (>=5.0)	✘	-	ON	ON	Automatic
ECn	Configuration error	✘	-	ON	ON	Automatic
ELE	EVD offline	✘	-	ON	ON	Automatic

Tab. 8.b

**8.6 EVDice alarms**

If an EVDice driver is connected via Fieldbus, UltraCella will be able to signal the following alarms, which depend solely on the status of the driver.

Alarm code on display	Alarm description	Button flashing on display	Icon flashing on display	Alarm relay	Buzzer	Reset
IA1	Probe S1 fault	✘	-	ON	ON	Automatic
IA2	Probe S2 fault	✘	-	ON	ON	Automatic
IE1	MOP protection	✘	-	ON	ON	Automatic
IE2	LOP protection	✘	-	ON	ON	Automatic
IE3	Low superheat protection	✘	-	ON	ON	Automatic
IE4	Low suction temperature alarm	✘	-	ON	ON	Automatic
IE5	Valve emergency closing (Ultracap)	✘	-	ON	ON	Automatic
IE6	Regulation by digital input in case of offline	✘	-	ON	ON	Automatic
IE7	Ultracap module powered with low voltage or low charge level	✘	-	ON	ON	Automatic
IE8	Emergency closure is not completed	✘	-	ON	ON	Automatic
IEE	Operating and/or parameter EEPROM error	✘	-	ON	ON	Automatic
ILE	EVD ICE offline	✘	-	ON	ON	Automatic
IEC	Configuration error	✘	-	ON	ON	Automatic
IEM	Alignment error with UltraCella	✘	-	ON	ON	Manual

Tab. 8.c

8.7 3PH module alarms

Alarm code on display	Alarm cause	Button flashing on display	Icon flashing on display	Alarm relay	Buzzer	Reset
EPE	3PH Module off -line		-	ON	ON	Automatic
EP0	Sd1 probe fault (3PH module)		-	ON	ON	Automatic
EP1	Sd2 probe fault (3PH module)		-	ON	ON	Automatic
EP2	Sc probe fault (3PH module)		-	ON	ON	Automatic
EPn	3PH module configuration fault		-	ON	ON	Automatic
EPM	Motor protector alarm (3PH module)		-	ON	ON	Manual
EPU	High/low pressure or Kriwan alarm (3PH module)		-	ON	ON	Manual

Tab. 8.d

ALARM TABLE

Cod. display	Alarm cause	Icon on the display flashing	Display key flashing	Alarm relay	Buzzer	Reset	PD valve	Compressor	Defrost	Evaporator Fans	Condenser fans	Continuous cycle
rE	Virtual control probe fault			ON	ON	automatic	duty setting(c4)	duty setting(c4)	-	-	-	OFF
E0	Probe B1 fault			ON	ON	automatic	duty setting(c4)	duty setting(c4)	-	-	-	OFF
E1	Probe B2 fault			ON	ON	automatic	-	-	-	-	-	OFF
E2	Probe B3 fault			ON	ON	automatic	-	-	-	-	-	-
E3	Probe B4 fault			ON	ON	automatic	-	-	-	-	-	-
E4	Probe B5 fault			ON	ON	automatic	-	-	-	-	-	-
LO	Low temperature alarm	-		ON	ON	automatic	-	-	-	-	-	-
HI	High temperature alarm	-		ON	ON	automatic	-	-	-	-	-	-
IA	Immediate alarm from external contact	-		ON	ON	automatic	duty setting (A6)	duty setting(A6)	OFF	OFF	OFF	OFF
SA	Serious alarm from external contact	-		ON	ON	automatic	OFF	OFF	OFF	OFF	OFF	OFF
Pd	Maximum pump down time alarm	-		ON	ON	automatic	-	-	-	-	-	-
LP	Low pressure alarm	-		ON	ON	automatic	OFF	OFF	OFF	-	-	-
AtS	Autostart in pump down	-		ON	ON	autom./man	-	-	-	-	-	-
CHt	High condenser temperature alarm	-		ON	ON	manual	OFF	OFF	-	-	OFF	-
dor	Door open too long alarm	-		ON	ON	automatic	-	-	-	-	-	-
Etc	Real time clock is broken	-		ON	ON	automatic	-	-	-	-	-	-
EE	EEProm error, unit parameters			ON	ON	automatic	-	-	-	-	-	-
EF	Eeprom error, operating parameters			ON	ON	automatic	-	-	-	-	-	-
Ed1, Ed2	Defrost ended by timeout	-		ON	ON	automatic	-	-	-	-	-	-
HA	HACCP alarm, HA type	-		ON	ON	manual	-	-	-	-	-	-
HF	HACCP alarm, HF type	-		ON	ON	manual	-	-	-	-	-	-
LoG	Download recorded temperature fault	-		OFF	ON	automatic	-	-	-	-	-	-
uPL	Parameters upload fault	-		OFF	ON	automatic	-	-	-	-	-	-
dnL	Parameters download fault	-		OFF	ON	automatic	-	-	-	-	-	-
SOF	Software update fault	-		OFF	ON	automatic	-	-	-	-	-	-
SHA	EVD EVO - Low superheat protection	-		ON	ON	automatic	OFF	OFF	OFF	-	-	-
LOA	EVD EVO - LOP protection	-		ON	ON	automatic	OFF	OFF	OFF	-	-	-
MOA	EVD EVO - MOP protection	-		ON	ON	automatic	OFF	OFF	OFF	-	-	-
EEA	EVD EVO - Valve motor fault	-		ON	ON	automatic	OFF	OFF	OFF	-	-	-
LSA	EVD EVO - Low suction temperature	-		ON	ON	automatic	-	-	-	-	-	-
Hit	EVD EVO - High condensing temperature protection activated	-		ON	ON	automatic	-	-	-	-	-	-
ES1	EVD EVO - Probe S1 fault or range exceeded alarm	-		ON	ON	automatic	OFF	OFF	OFF	-	-	-
ES2	EVD EVO - Probe S2 fault or range exceeded alarm	-		ON	ON	automatic	OFF	OFF	OFF	-	-	-
ES3	EVD EVO - Probe S3 fault or range exceeded alarm	-		ON	ON	automatic	-	-	-	-	-	-
ES4	EVD EVO - Probe S4 fault or range exceeded alarm	-		ON	ON	automatic	-	-	-	-	-	-
bAt	EVD EVO - Battery discharged or faulty or electrical connection interrupted	-		ON	ON	automatic	-	-	-	-	-	-
EEE	EVD EVO - Operating and/or parameter EEPROM error	-		ON	ON	automatic	OFF	OFF	OFF	-	-	-
EIC	EVD EVO - Valve not closed completely	-		ON	ON	automatic	-	-	-	-	-	-
EEC	EVD EVO - Valve closed in emergency	-		ON	ON	automatic	OFF	OFF	OFF	-	-	-
EFu	EVD EVO - FW compatibility error (>=5.0)	-		ON	ON	automatic	-	-	-	-	-	-
ECn	EVD EVO - Configuration error	-		ON	ON	automatic	-	-	-	-	-	-
ELE	EVD EVO - EVD offline	-		ON	ON	automatic	OFF	OFF	OFF	-	-	-
ALM	Alarm log download log not successful	-		OFF	ON	automatic	-	-	-	-	-	-
EPE	Off-line 3PH module	-		ON	ON	automatic	OFF	OFF	OFF	OFF	-	-
				ON	ON	automatic	-	-	-	-	-	-
EP0	Sd1 probe fault (3PH module)	-							End by time if Sd1 only	-	-	-



EP1	Sd2 probe fault (3PH module)	-	ON	ON	automatic	-	-	-	-	-	-
EP2	Sc probe fault (3PH module)	-	ON	ON	automatic	-	-	-	-	-	-
EPn	3PH module configuration fault	-	ON	ON	automatic	OFF	OFF	OFF	OFF	OFF	-
EPM	Motor protector alarm (3PH module)	-	ON	ON	manual	OFF	OFF	OFF	OFF	OFF	-
EPU	High/low pressure or Kriwan alarm (3PH module)	-	ON	ON	manual	OFF	OFF	OFF	OFF	OFF	-
AUH	High humidity alarm	-	ON	ON	automatic	-	-	-	-	-	-
AUL	Low humidity alarm	-	ON	ON	automatic	-	-	-	-	-	-
GH1	High generic alarm (stage 1 ON/OFF – generic function)	-	ON	ON	automatic	-	-	-	-	-	-
GL1	Low generic alarm (stage 1 ON/OFF – generic function)	-	ON	ON	automatic	-	-	-	-	-	-
GH2	High generic alarm (stage 2 ON/OFF – generic function)	-	ON	ON	automatic	-	-	-	-	-	-
GL2	Low generic alarm (stage 2 ON/OFF – generic function)	-	ON	ON	automatic	-	-	-	-	-	-
GH6	Generic high alarm (stage 3 ON/OFF - generic func.)	-	ON	ON	automatic	-	-	-	-	-	-
GL6	Serious alarm from external contact	-	ON	ON	automatic	-	-	-	-	-	-
GH3	High generic alarm (modulating output – generic function)	-	ON	ON	automatic	-	-	-	-	-	-
GL3	Low generic alarm (modulating output – generic function)	-	ON	ON	automatic	-	-	-	-	-	-
GA1	Generic alarm (alarm 1 – generic function)	-	ON	ON	automatic	-	-	-	-	-	-
GA2	Generic alarm (alarm 2 – generic function)	-	ON	ON	automatic	-	-	-	-	-	-
IA1	EVD ICE – Probe S1 fault	-	ON	ON	automatic	OFF	OFF	OFF	-	-	-
IA2	EVD ICE – Probe S2 fault	-	ON	ON	automatic	OFF	OFF	OFF	-	-	-
IE1	EVD ICE – MOP protection	-	ON	ON	automatic	OFF	OFF	OFF	-	-	-
IE2	EVD ICE – LOP protection	-	ON	ON	automatic	OFF	OFF	OFF	-	-	-
IE3	EVD ICE – Low superheat protection	-	ON	ON	automatic	OFF	OFF	OFF	-	-	-
IE4	EVD ICE – low suction temperature alarm	-	ON	ON	automatic	-	-	-	-	-	-
IE5	EVD ICE – valve in emergency closing (Ultracap)	-	ON	ON	automatic	OFF	OFF	OFF	-	-	-
IE6	EVD ICE – control from dig. input if offline	-	ON	ON	automatic	OFF	OFF	OFF	-	-	-
IE7	EVD ICE – Ultracap module powered with low voltage or low charge level	-	ON	ON	automatic	-	-	-	-	-	-
IE8	EVD ICE – incomplete valve closing	-	ON	ON	automatic	OFF	OFF	OFF	-	-	-
IEE	EVD ICE – operating_and/or parameter EEPROM error	-	ON	ON	automatic	OFF	OFF	OFF	-	-	-
ILE	EVD ICE – EVDICE offline	-	ON	ON	automatic	OFF	OFF	OFF	-	-	-
IEC	EVD ICE – Configuration error	-	ON	ON	automatic	OFF	OFF	-	-	-	OFF
IEM	EVD ICE – Alignment error with UltraCella	-	ON	ON	manual	-	-	-	-	-	-

Tab. 8.e

### 8.8 Alarm parameters

#### High and low temperature alarm and activation parameters

AL (AH) allows you to determine the activation temperature for low (high) temperature alarm LO (HI). The set value AL (AH) is always compared with the value detected by the control probe. The parameter Ad represents the alarm activation delay in minutes; the low temperature alarm (LO) activates only if the temperature is lower than threshold AL for period of time greater than Ad. The thresholds can be relative or absolute, depending on the value of parameter A1. In the first case (A1=0) the value AL indicates the deviation regarding the set point and the low temperature alarm activation point is: set point - AL. If the set point differs, the activation point will automatically differ. In the second case (A1=1), the value AL indicates the low temperature alarm threshold. An active low temperature alarm is indicated via internal buzzer, with the code LO on display and with the activation of the alarm relay. The same occurs for high temperature alarm (HI), considering AH instead of AL.

Par	Description	Def	Min	Max	UM
A0	Alarm and fan differential	2.0	0.1	20.0	°C/°F
A1	Alarms threshold (AL, AH) relative to set point or absolute 0/1=relative/absolute	0	0	1	-
AL	Low temperature alarm threshold If A1=0, AL=0: alarm disabled If A1=1, AL=-50: alarm disabled	0	-50.0	200	°C/°F
AH	High temperature alarm threshold If A1=0, AL=0: alarm disabled If A1=1, AL=200: alarm disabled	0	-50.0	200	°C/°F
Ad	Delay time for low temperature and high temperature alarms	120	0	250	min
A6	Stop compressor from external alarm 0 = compressor always off; 100 = compressor always on;	0	0	100	min

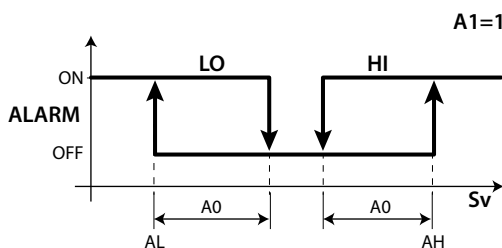


Fig. 8.a

#### Key

LO	Low temperature alarm
HI	High temperature alarm
SV	Adjustment probe



#### Notes:

- The alarm LO and HI are alarms with automatic reset. A0 determines the hysteresis between the value of the activation and deactivation of the alarm;
- if you press the Alarm button when the measurement is above a threshold, the buzzer and the alarm relay immediately turn off, and an indication of the alarm code will remain active until the measure falls within the activation threshold. Parameter A6 has similar meaning as parameter c4 (duty setting). If an external alarm occurs, the compressor works for a time equal to the value set for parameter A6, while it remains OFF for a fixed period of 15 minutes.
- In case of relative alarms (A1= 0) both AL and AH are considered as absolute values (e.g. AL= -10 is considered as AL= 10)

#### High and low humidity alarms parameters

If either input B4 or B5 is configured for a humidity probe (On), high (AUH) and low humidity alarms (AUL) can also be enabled, with absolute thresholds (UHL and ULL). The alarms are activated in the following conditions:

- If Su >= UHL --> high humidity alarm AUH
- If Su <= ULL --> low humidity alarm AUL

Par	Description	Def	Min	Max	UM
ULL	Absolute low humidity alarm threshold 0=alarm disabled	0	0	100.0	%rH
UHL	Absolute high humidity alarm threshold 100=alarm disabled	100.0	0	100.0	%rH
AdH	Humidity alarms AUH, AUL delay	120	0	250	min



### 8.9 HACCP Alarm parameters and monitoring activation

In order to activate HACCP alarm monitoring, set parameter HCE=1.

#### HA alarms

The HA alarm is generated if during normal operation it is noted that the temperature read by the control probe exceeds the high temperature threshold for the time Ad + Htd. Therefore compared to the normal high temperature alarm already signalled by the control, HACCP alarm type HA is delayed by a further Htd time specific for HACCP recording.

Par.	Description	Def	Min	Max	UoM
HCE	Enabling HACCP 0/1=No/Yes	0	0	1	-
Htd	HACCP alarm delay	0	0	250	min

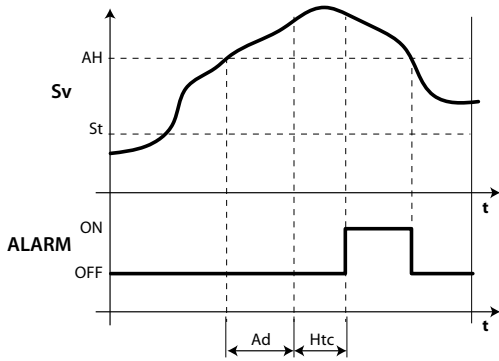


Fig. 8.b

#### Key

Sv	Virtual probe
St	Set point
t	Time
AH	High temperature alarm threshold
ALARM	HACCP alarm, HA type
Ad	Delay time for low temperature and high temperature alarms
Htd	HACCP alarm delay (0=monitoring disabled)

#### HF alarms

The HACCP alarm type HF is generated as a result of a power failure for a long time (> 1 minute), when after mains voltage restore the temperature read by the adjustment probe exceeds the high temperature threshold AH.

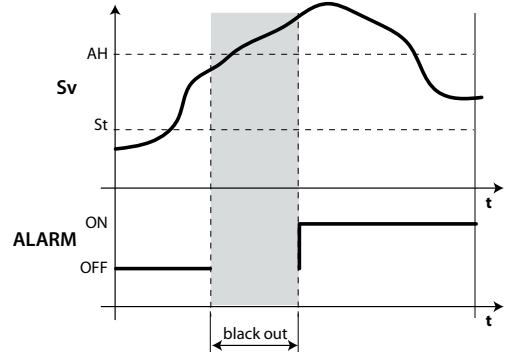


Fig. 8.c

#### Key

Sv	Virtual probe
AH	High temperature alarm threshold
ALARM	HACCP alarm, HF type
St	Set point
t	Time

### 8.10 High condenser temperature alarm

You can monitor the temperature of the condenser to signal the high temperature, probably due to situations of clogging. The signalling follows the figure below.

Par	Description	Def	Min	Max	UM
Ac	High condenser temperature alarm threshold	70	-50,0	200	°C/°F
Acđ	High condenser temperature alarm delay	0	0	250	min

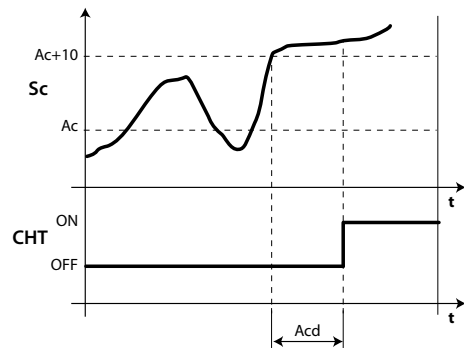


Fig. 8.d

#### Key

t	Time
Acđ	High condenser temperature alarm delay
Sc	Condenser probe
Ac	High condenser temperature alarm threshold
CHT	High condenser temperature alarm

## 9. TECHNICAL SPECIFICATIONS

### 9.1 UltraCella technical characteristics

Power Supply	Model 230V: Voltage 230 V~ (+10/-15%), 50/60 Hz; Power 18 VA, 100 mA~ max. Model 24V: Voltage 24 V~ (+10/-15%), 50/60 Hz; Power 18 VA, 1A~ max.	
Insulation ensured by 230V power supply	Insulation for low voltage: reinforced, 6 mm in air, 8 mm superficial, 3750 V. Insulation for relay outputs: reinforced, 3 mm in air, 4 mm superficial, 1250 V.	
Analog inputs	B1, B2, B3: NTC, PT1000 (+-3%) B4: NTC, 0...10Vdc (+-3%) B5: 0...5Vdc ratiometric (+-3%), 4...20mA (+-3%)	
Analog output	Y1: 0...10 Vdc (10mA max,+5%)	
Note:	When installing, keep the supply and loads connections away from the cables of the probes, digital inputs, and monitoring device.	
Probe Type	NTC std. CAREL: 10 kΩ at 25°C, range from -50°C to 90°C; measuring error: 1°C in range from -50°C to +50°C; 3°C in range from +50°C to +90°C NTC HT: 50 kΩ at 25°C, range from 0°C to 150°C; measuring error: 1.5°C in range from 0°C to +115°C; 4°C in range from +115°C to +150°C PT1000 std. CAREL: 1000 Ω at 0°C, range from -50°C to +90°C; measuring error 3°C in range from -50°C to 0°C; 5°C in range from 0°C to +90°C	
Probe power supply	+Vdc 12 V+30%, 25 mA max; 5VREF: 5V+2%	
Relay output	Applicable ratings based on the relay type	
	<b>Type of Relay</b>	<b>EN60730 -1 (250 V ~)</b>
	8A (AUX1, AUX2)	8 (4)A on N.O.; 6 (4)A on N.C.; 2 (2)A on N.C. and N.O. (100000 cycles)
	16A,(LIGHT, FAN)	10A resistive, 5 (3)A (100000 cycles)
	30A(COMP, DEF)	12 (10)A (100000 cycles)
		<b>UL 873 (250 V ~)</b>
		8A resistive 2FLA 12LRA, C300 (30000 cycles)
		10A resistive, 5FLA 18LRA (30000 cycles)
		12A resistive, 2HP, 12FLA 72LRA (30000 cycles)
	<b>NOTE:</b> The sum of the loads currents COMP, DEF, FAN accessed at the same time should not exceed 20A	
	Insulation for low voltage: reinforced, 6 mm in air, 8 superficial, 3750 V. Insulation between independent relay outputs: reinforced, 3 mm in air, 4 superficial, 1250 V.	
Connections	Section of conductors for analog inputs and outputs, digital inputs, serial: from 0.5 to 2.5mm <sup>2</sup> (from 20 to 13 AWG); Section of supply and loads cables: from 1.5 to 2.5 mm <sup>2</sup> (from 15 to 13 AWG) Serial connections:use shielded cables Maximum length of the cables: 10 m	
Container	Plastic: sizes 200 x 100 X 190 mm	
Assembly	On wall (with plastic container): using fastening screws for front board	
Display	LED display: 3 and 4 digits, display from -99 to 999; operating status indicated by LEDs and icons formed on the polycarbonate applied to the plastic	
Keyboard	10 keys on keyboard in polycarbonate membrane applied to the plastic	
Clock with buffer battery	Available depending on the model	
Buzzer	Available on all models.	
Clock	Depending on the model installed. Accuracy: ±100 ppm Battery: "button" type with lithium code CR2430 voltage: 3Vdc (sizes 24x3 mm)	
Serial	3 types of available serials: pLAN, BMS, Fieldbus PLAN : Driver HW RS485, telephone jack (available only on few models) and screw terminals BMS Driver HW RS485, screw terminals Fieldbus: Driver HW RS485, screw terminals	
USB	Type: Host (A connector); 5Vdc supply, maximum absorption: 100mA (low power devices)	

Operating conditions	Only board: -10T65°C; <90% U.R. non condensing																												
	With plastic container: -10T50°C, <90% U.R. non condensing																												
<table border="1"> <thead> <tr> <th>Relay</th> <th>Associated load</th> <th>Type of Relay</th> <th>Max resistive current applicable</th> </tr> </thead> <tbody> <tr> <td>R1</td> <td>(AUX2)</td> <td>8A</td> <td>8A</td> </tr> <tr> <td>R2</td> <td>(AUX1)</td> <td>8A</td> <td>8A</td> </tr> <tr> <td>R3</td> <td>(LIGHT)</td> <td>16A</td> <td>10A</td> </tr> <tr> <td>R4</td> <td>(FAN)</td> <td>16A</td> <td>10A</td> </tr> <tr> <td>R5</td> <td>(DEF)</td> <td>30A</td> <td>12A</td> </tr> <tr> <td>R6</td> <td>(COMP)</td> <td>30A</td> <td>12A</td> </tr> </tbody> </table>	Relay	Associated load	Type of Relay	Max resistive current applicable	R1	(AUX2)	8A	8A	R2	(AUX1)	8A	8A	R3	(LIGHT)	16A	10A	R4	(FAN)	16A	10A	R5	(DEF)	30A	12A	R6	(COMP)	30A	12A	Relay identification, type and maximum resistive current to operating temperature:
	Relay	Associated load	Type of Relay	Max resistive current applicable																									
	R1	(AUX2)	8A	8A																									
	R2	(AUX1)	8A	8A																									
	R3	(LIGHT)	16A	10A																									
	R4	(FAN)	16A	10A																									
	R5	(DEF)	30A	12A																									
R6	(COMP)	30A	12A																										
Storage conditions	-20T70°C, < 90% U.R. non condensing																												
Front protection rating	With plastic container: IP65																												
Environmental pollution	2, normal situation																												
PTI of the isolating materials	Printed circuits 250, plastic and insulation materials 175																												
Resistance to fire class:	Category D																												
Protection against overcharging class	Category II, without PE terminal Category I, with PE terminal																												
Type of action and disconnection	Relay contact 1 B (micro-disconnection)																												
Control system manufacture	Incorporated, electronic control device																												
Classification according to protection against electric shock	Class II by means of appropriate incorporation																												
Device intended to be hand-held or built into equipment designed to be hand held	No																												
Class and structure of the software	Class A																												
Control front cleaning	Only use neutral detergents and water																												

Tab. 9.a

## 9.2 EVD Modules technical characteristics

Power supply	voltage: 230 V~ (+10/-15%), 50/60 Hz; power: 4,5kW max. <b>NOTE:</b> The maximum simultaneous current draw by all the loads connected to the controller and the expansion modules must not exceed 20 A.
Classification according to protection against electric shock	Class II
Case	plastic, dimensions 128x290x110 mm
Front protection rating with plastic case	IP65
Fire resistance category	category D
Cleaning the module front panel	only use neutral detergents and water
Operating conditions	-10T40°C, <90% r.H. non condensing
Storage conditions	-20T60°C, <90% r.H. non condensing
PTI of insulating materials	printed circuits 250, plastic and insulating materials 175

Tab. 9.b

## 9.3 Power Modules technical characteristics

Power supply	voltage: 230 V~ (+10/-15%), 50/60 Hz; power: 4,5kW max. <b>NOTE:</b> The maximum simultaneous current draw by all the loads connected to the controller and the expansion modules must not exceed 20 A
Residual current circuit breaker	In=20 A @30 °C, Id=300 mA
Power relay	Rating: 30 A resistive, 240 Vac; 3HP 240 Vac
Classification according to protection against electric shock	Class II
Case	plastic, dimensions 128x290x110 mm
Front protection rating with plastic case	IP65
Fire resistance category	Category D
Cleaning the module front panel	only use neutral detergents and water
Operating conditions	-10T40°C, <90% r.H. non condensing
Storage conditions	-20T60°C, <90% r.H. non condensing

Tab. 9.c

## 9.4 3PH EVAPORATOR Modules technical characteristics

Power supply	voltage: 400V~(+10/-15%), 50/60Hz, 3PH+N+T, I <sub>max</sub> 25A
Classification according to protection against electric shock	Class I
Case	plastic, dimensions 452x380x186 mm
Weight	8,7 Kg
Front protection rating with plastic case	IP65
Cleaning the module front panel	only use neutral detergents and water
Operating conditions	-10T40°C, <90% r.H. non condensing
Storage conditions	-20T60°C, <90% r.H. non condensing
Materials	frontal cover in polycarbonate, retro box in technopolymer

Tab. 9.d

### 9.4.1 Electrical characteristics

	Ultra 3PH Evaporator module 6kW	Ultra 3PH Evaporator module 9kW	Ultra 3PH Evaporator module 20kW
Code	WT00E600N0	WT00E900N0	WT00EA00N0
General			
Main switch / general protection	4-pole circuit breaker 16A 6kA D	4-pole circuit breaker 25A 6kA D	4-pole circuit breaker 40A 6kA D
Loads power supply	400V~(±10%), 50/60Hz, 3PH+N+T	400V~(±10%), 50/60Hz, 3PH+N+T	400V~(±10%), 50/60Hz, 3PH+N+T
Insulating transformer	PRI 230 Vac SEC1 230 Vac 40VA SEC2 24 Vac 35VA SEC protection by fuses	PRI 230 Vac SEC1 230 Vac 40VA SEC2 24 Vac 35VA SEC protection by fuses	PRI 230 Vac SEC1 230 Vac 40VA SEC2 24 Vac 35VA SEC protection by fuses
Status and alarm indication	By UltraCella	By UltraCella	by UltraCella
Input			
Main defrost probe	NTC 10kΩ	NTC 10kΩ	NTC 10kΩ
Auxiliary evap. defrost probe	NTC 10kΩ	NTC 10kΩ	NTC 10kΩ
Clicson evaporator	Present	Present	Present
Thermostat evaporator	Present	Present	Present
Output			
Condensing unit enabling / Solenoid valve	8A (AC1) / 2A (AC23) 1PH	8A (AC1) / 2A (AC23) 1PH	8A (AC1) / 2A (AC23) 1PH
Defrost heaters	6kW, 9A (AC1) 3PH	9kW, 13A (AC1) 3PH	20kW, 28A (AC1) 3PH
Evaporator fans	0,55kW, 1,5A* (AC23) 3PH 0...10Vdc	2kW, 5,7A* (AC23) 3PH 0...10Vdc	4kW, 9,6A* (AC23) 3PH 0...10Vdc
AUX1 output	16A (AC1) 1PH	16A (AC1) 1PH	16A (AC1) 1PH

Tab. 9.e

\* Rating with cosφ=0,5;

With different power factor, to calculate the rating consider the formula:  $I = P / (400 * \sqrt{3} * \cos\phi)$  where P is the power in W

## 9.5 3PH FULL Modules technical characteristics

Power supply	voltage: 400V~(+10/-15%), 50/60Hz, 3PH+N+T, I <sub>max</sub> 25A
Classification according to protection against electric shock	Class I
Case	plastic, dimensions 452x380x186 mm
Weight	9,8 Kg
Front protection rating with plastic case	IP65
Cleaning the module front panel	only use neutral detergents and water
Operating conditions	-10T40°C, <90% r.H. non condensing
Storage conditions	-20T60°C, <90% r.H. non condensing
Materials	frontal cover in polycarbonate, retro box in technopolymer

Tab. 9.f

### 9.5.1 Electrical characteristics

	Ultra 3PH Full module 4HP	Ultra 3PH Full module 7.5HP
Code	WT00F4B0N0	WT00F7C0N0
<b>General</b>		
Main switch / general protection	4 poles magnetothermic 16A 6kA D	4 poles magnetothermic 25A 6kA D
Loads power supply	400V~ (±10%), 50/60Hz, 3PH+N+T	400V~ (±10%), 50/60Hz, 3PH+N+T
Insulating transformer	PRI 230 Vac SEC1 230 Vac 40VA SEC2 24 Vac 35VA Protection SEC by fuses	PRI 230 Vac SEC1 230 Vac 40VA SEC2 24 Vac 35VA Protection SEC by fuses
Status and alarm indication	By UltraCella	By UltraCella
Regulation range of compressor current rating	10...16A (AC3) 3PH	16...20A (AC3) 3PH
<b>Input</b>		
Main defrost probe	NTC 10kΩ	NTC 10kΩ
Auxiliary evap. defrost probe	NTC 10kΩ	NTC 10kΩ
Condensing probe	NTC 10kΩ	NTC 10kΩ
Partial condenser	Present	Present
Pump down	Present	Present
High/Low pressure	Present	Present
Kriwan compressor	Present	Present
Clicson evaporator	Present	Present
Thermostat evaporator	Present	Present
<b>Output</b>		
Compressor	10...16A (AC3) 3PH	16...20A (AC3) 3PH
Oil compressor heater (Carter)	100W, 0,5A (AC1) 1PH	100W, 0,5A (AC1) 1PH
Condensing fans	0,8kW, 4A (AC15) 1PH	0,8kW, 4A (AC15) 1PH
Defrost heaters	6kW, 9A (AC1) 3PH	9kW, 13A (AC1) 3PH
Evaporator fans	0,55kW, 1,5A* (AC23) 3PH 0...10Vdc	2kW, 5,7A* (AC23) 3PH 0...10Vdc
AUX1 output	16A (AC1) 1PH	16A (AC1) 1PH
Solenoid valve	Present	Present

Tab. 9.g

\* Rating with  $\cos\phi=0,5$ ;

With different power factor, to calculate the rating consider the formula:  $I = P / (400 * \sqrt{3} * \cos\phi)$  where P is the power in W

# 10. ELECTRICAL WIRING 3PH MODULES

## 10.1 Electrical wiring 3PH EVAPORATOR Module

### 10.1.1 Power circuit

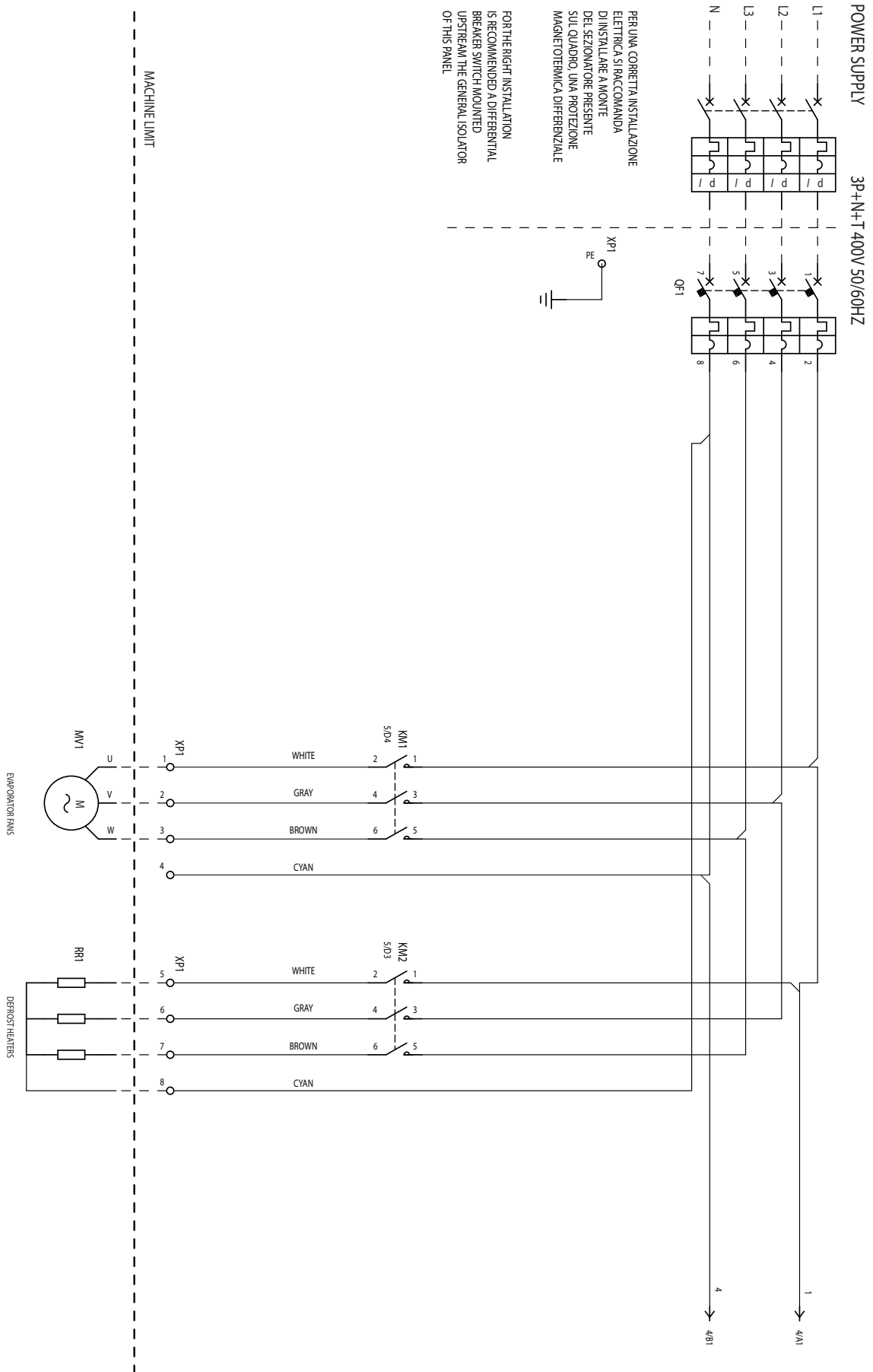


Fig. 10.a  
84

10.1.2 Power circuit

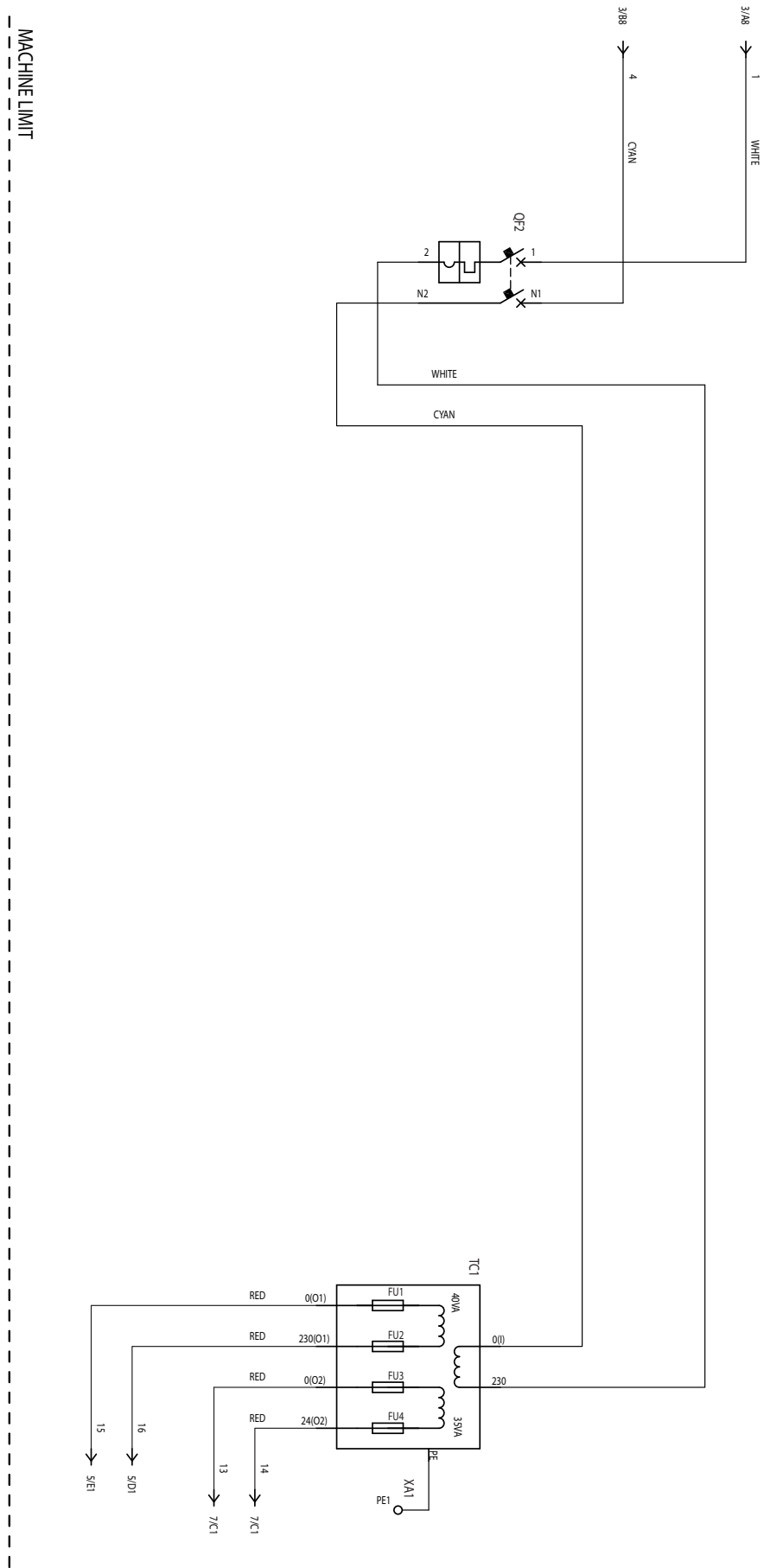


Fig. 10.b

10.1.3 Auxiliary circuit

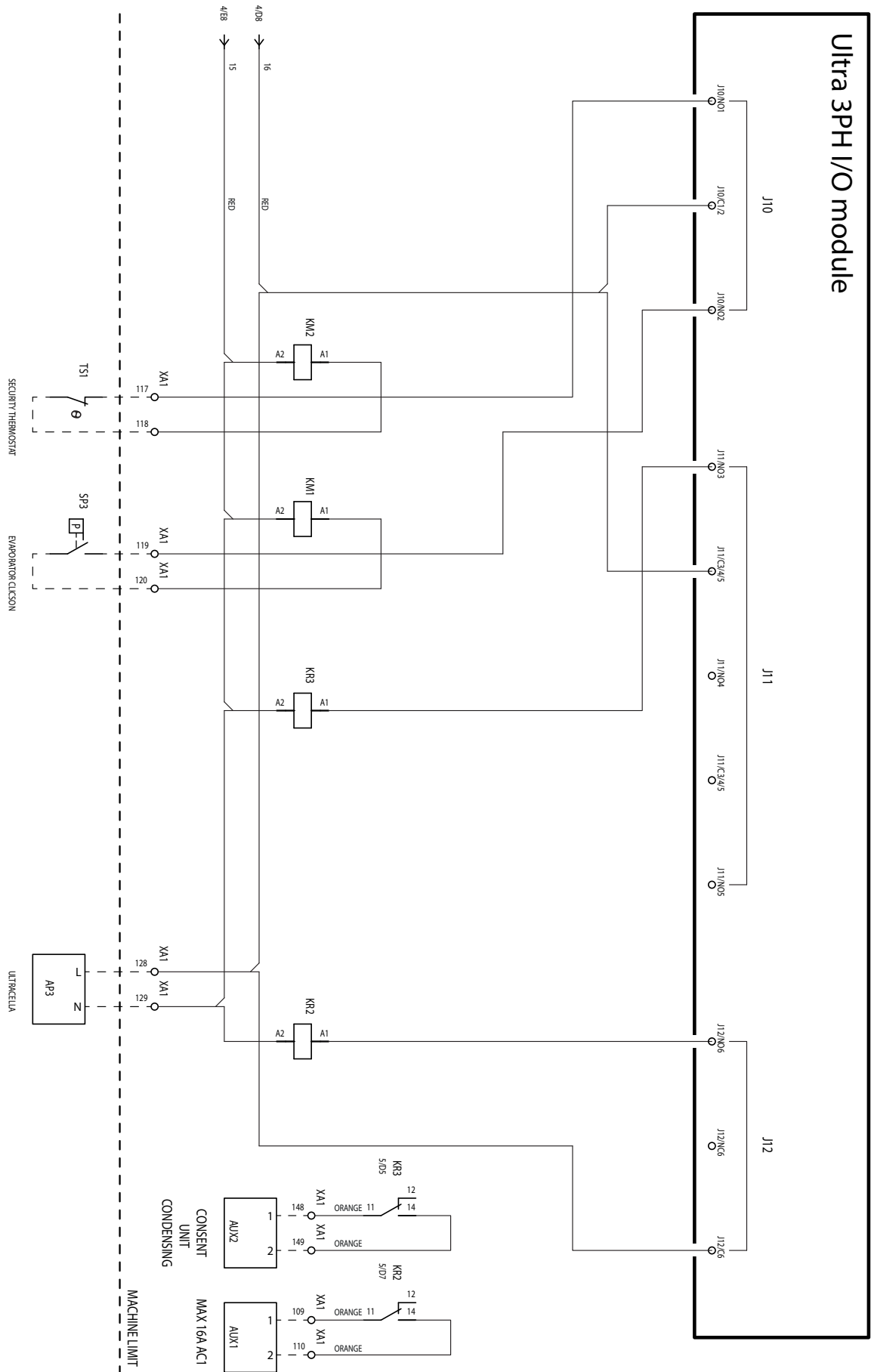


Fig. 10.c



10.1.4 Auxiliary circuit

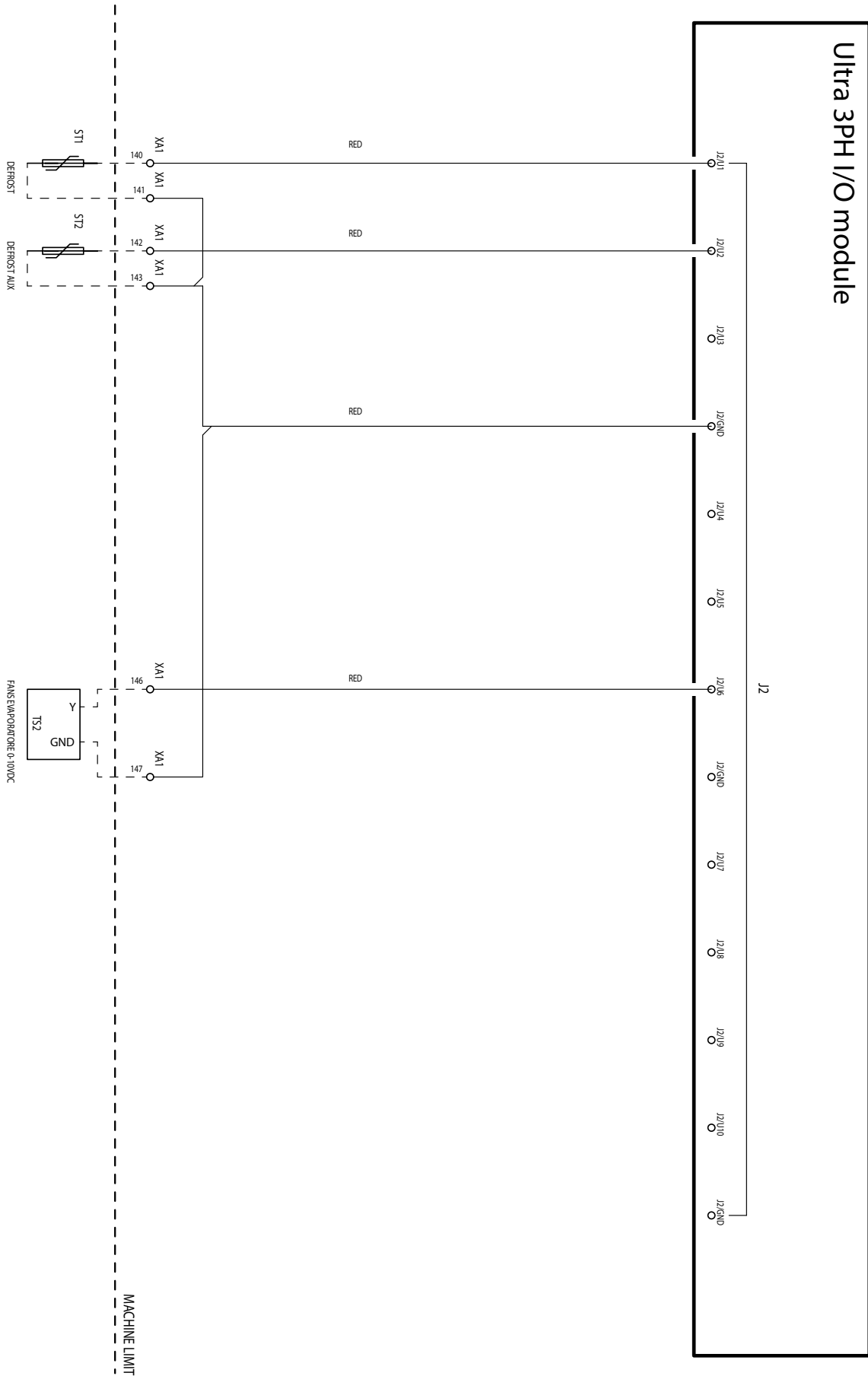


Fig. 10.d

10.1.5 Auxiliary circuit

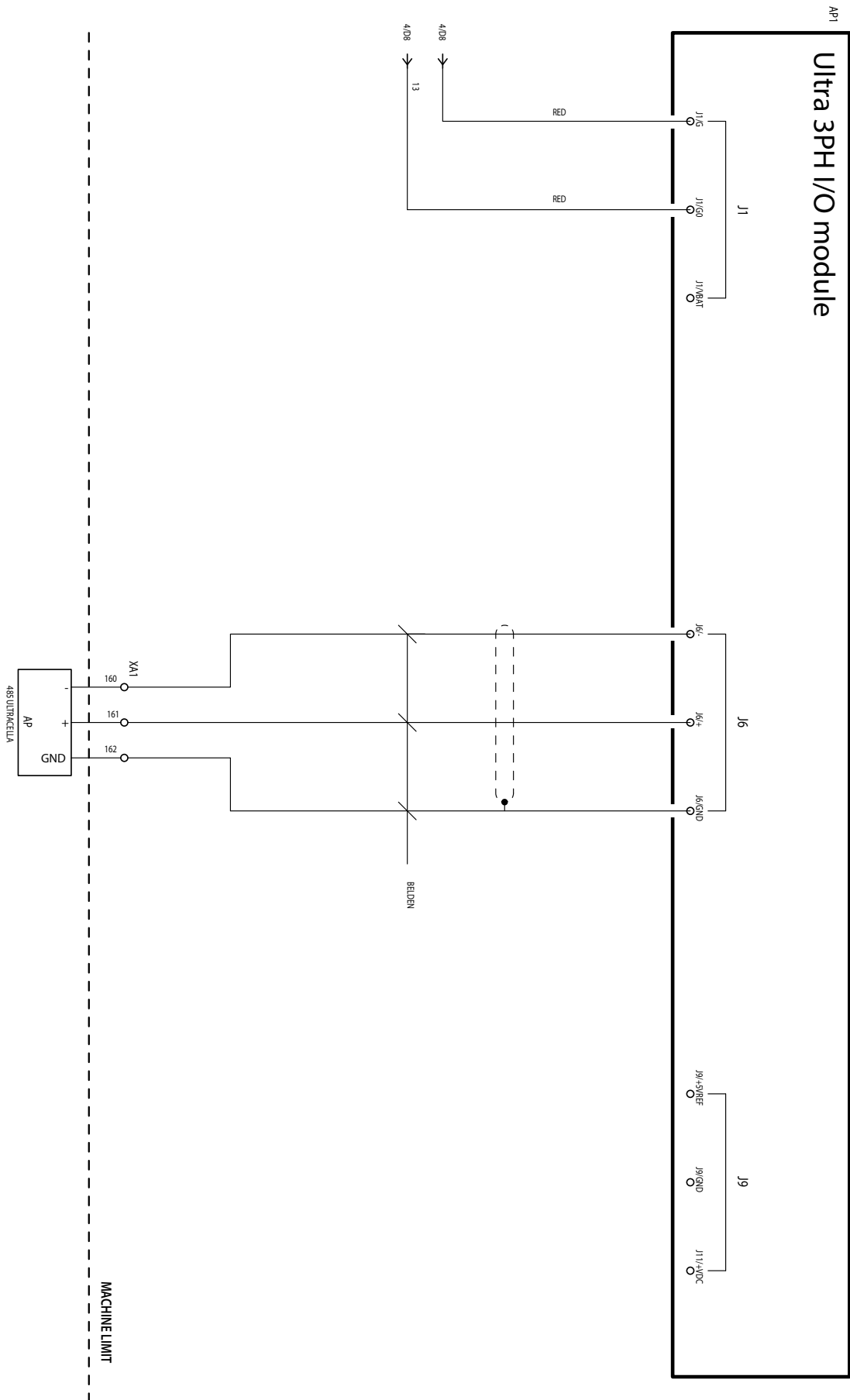
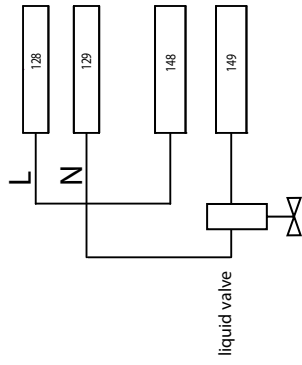


Fig. 10.e

**10.1.6 Connection for operation with power to solenoid valve**

If the solenoid valve requires power, the 230 Vac power supply available at terminals 128-129 can be used, as shown in the following wiring diagram:



10.1.7 Terminal units

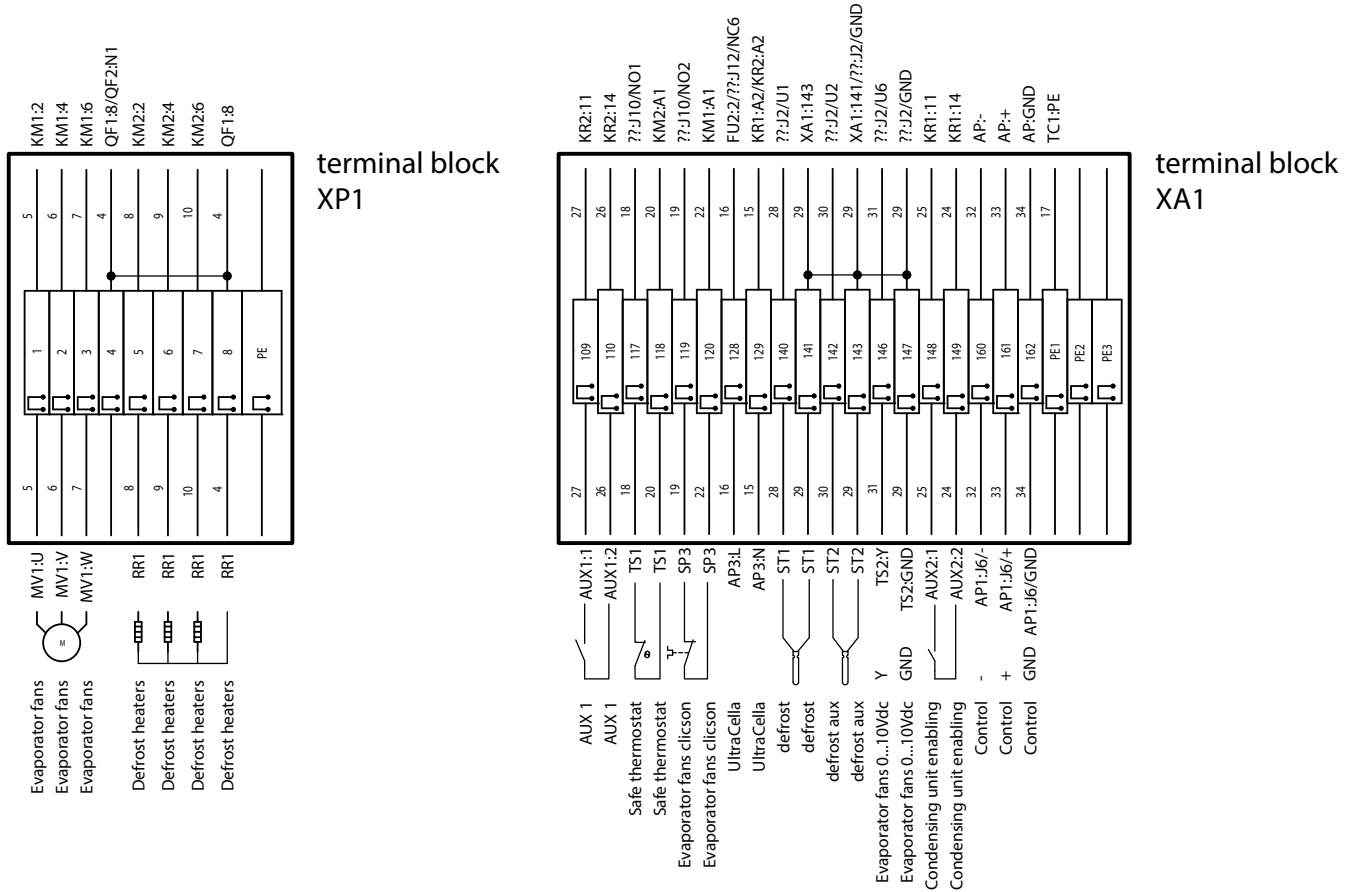


Fig. 10.f

Terminals	Number and description	Notes	
XP1	1	Evaporator fans	
	2		
	3		
	5	Defrost heaters	
	6		
	7		
	8		
	PE	Ground terminal	-
XA1	109	AUX1 relay	-
	110		-
	117	Safe thermostat evaporator fans	Normally closed. If active (open), evaporator fans are off and it's not notified in UltraCella
	118		
	119	Clicson evaporator fans	Normally closed. If active (open), evaporator fans are off and it's not notified in UltraCella
	120		-
	128	Power supply 230Vac for UltraCella	To supply UltraCella
	129		
	140	Defrost probe NTC	-
	141		-
	142	Defrost probe NTC aux evaporator	-
	143		-
	146	0...10V for evaporator fans (signal)	-
	147	0...10V for evaporator fans (GND)	-
	148	Condensing unit enabling / Solenoid valve	-
	149		
	160	RS485 -	Fieldbus - connection to UltraCella
161	RS485 +		
162	RS485 GND		
PE1		-	
PE2	Ground terminals	-	
PE3			

Tab. 10.a

## 10.2 Electrical wiring 3PH FULL Module

### 10.2.1 Power circuit

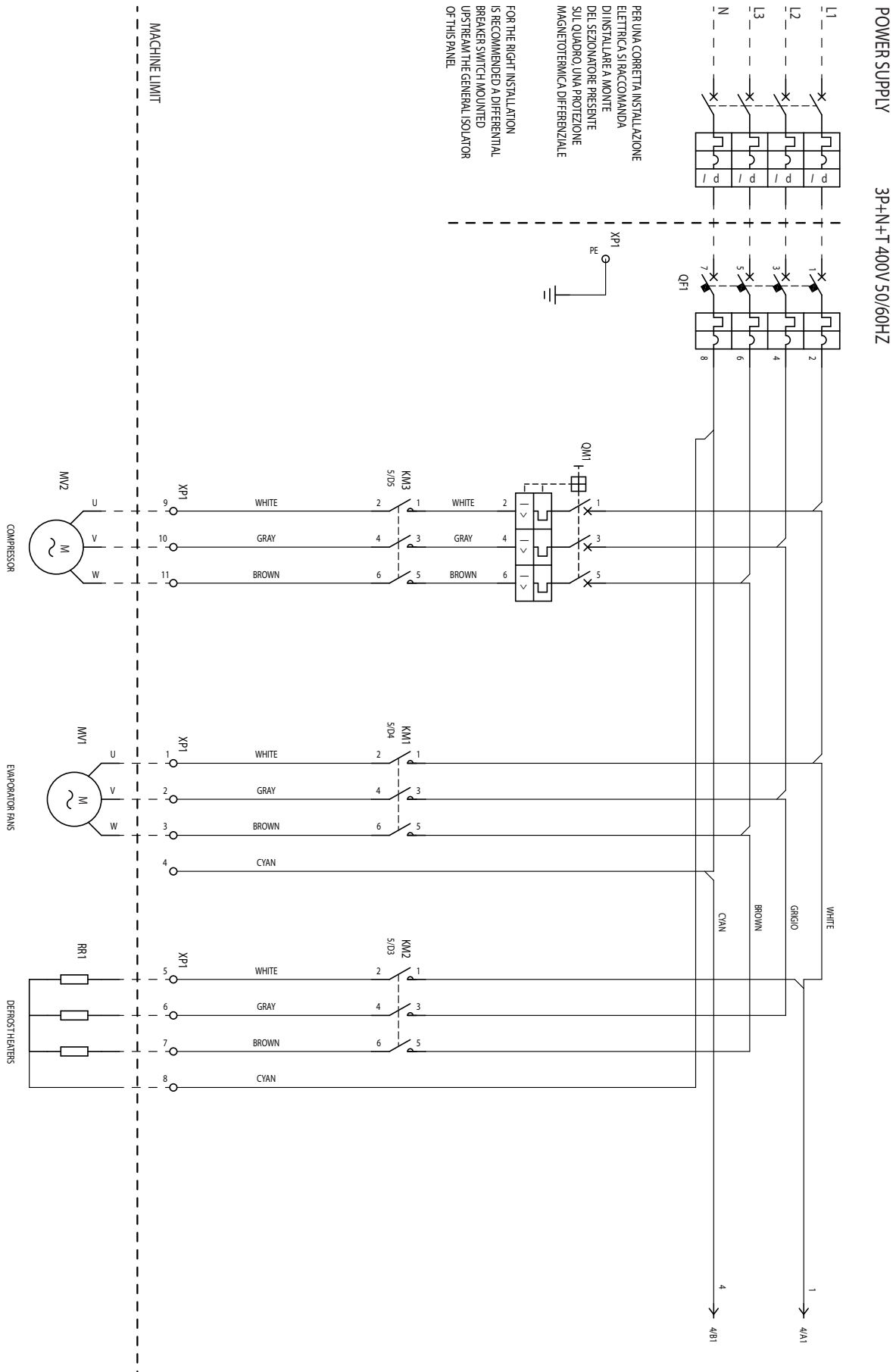


Fig. 10.g

10.2.2 Power circuit

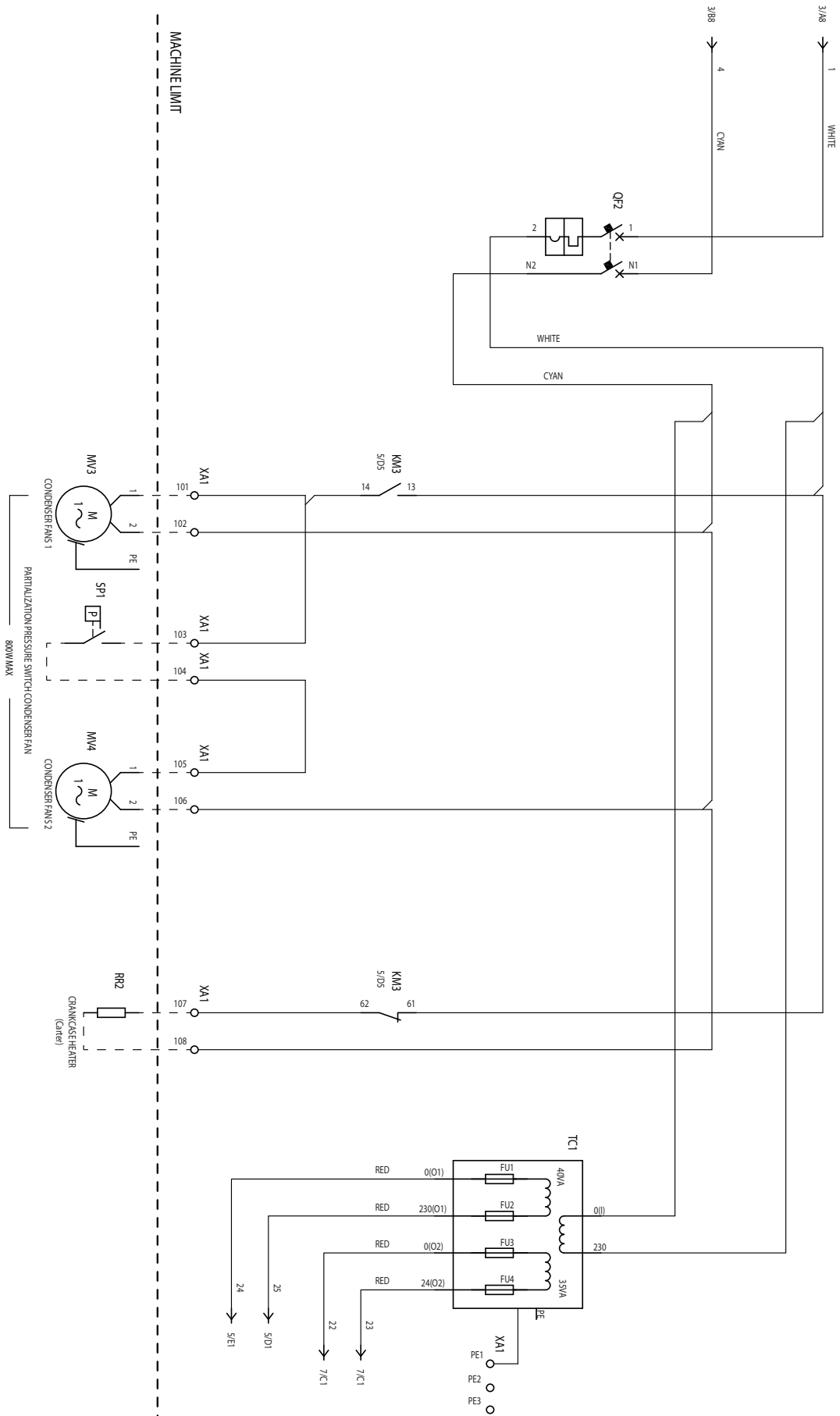


Fig. 10.h

10.2.3 Auxiliary circuit

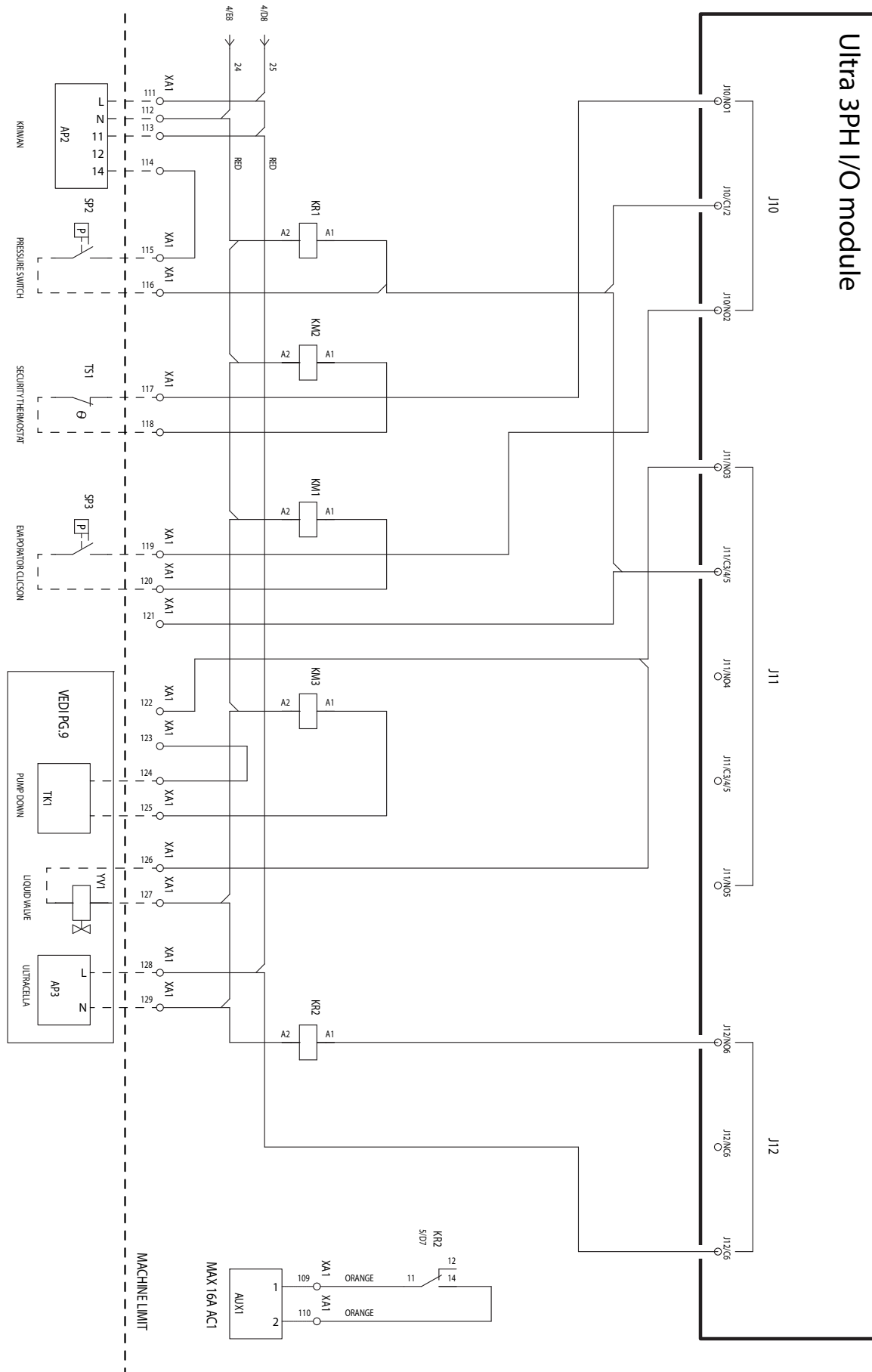


Fig. 10.i



10.2.4 Auxiliary circuit

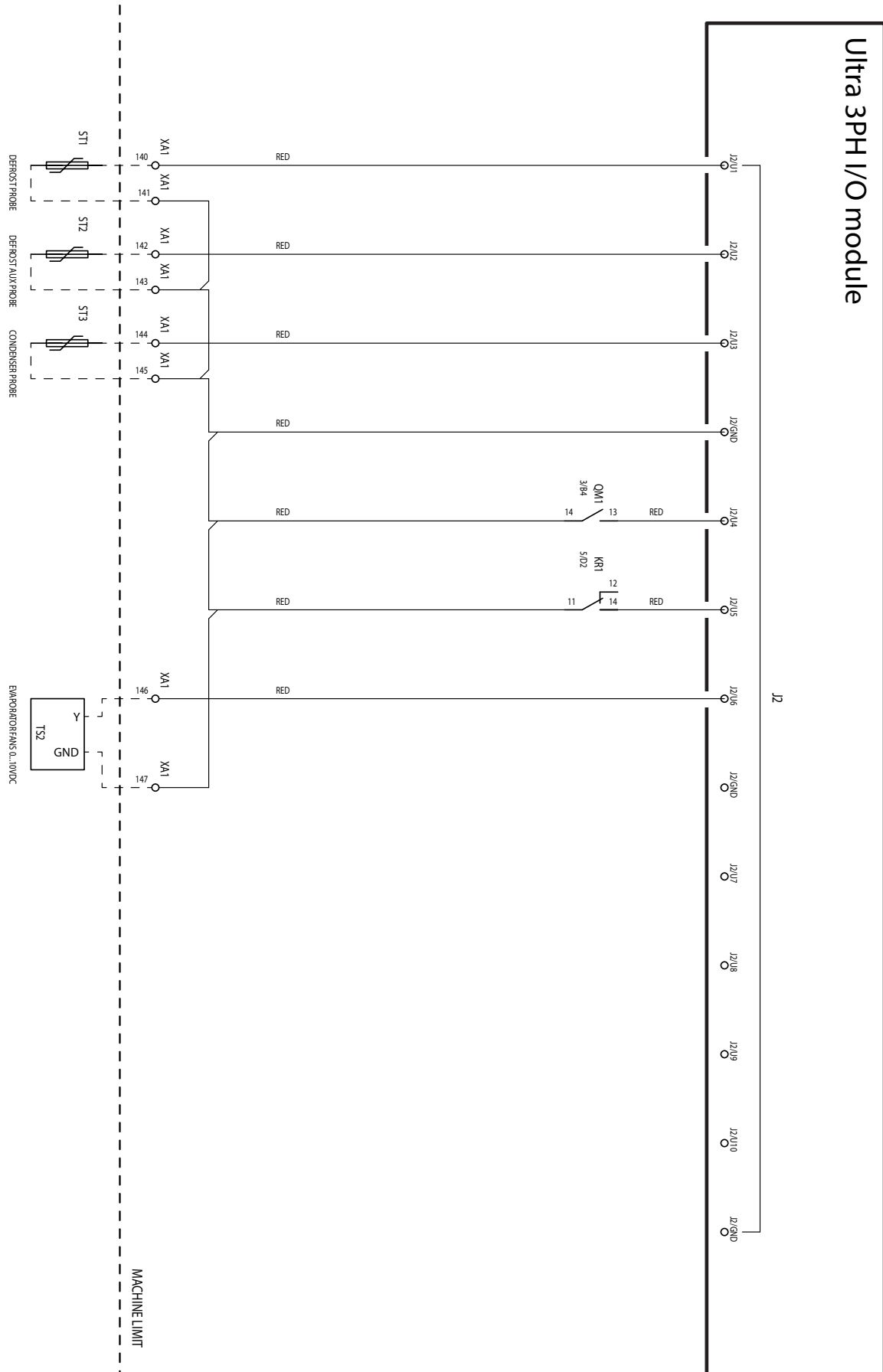


Fig. 10.j

10.2.5 Auxiliary circuit

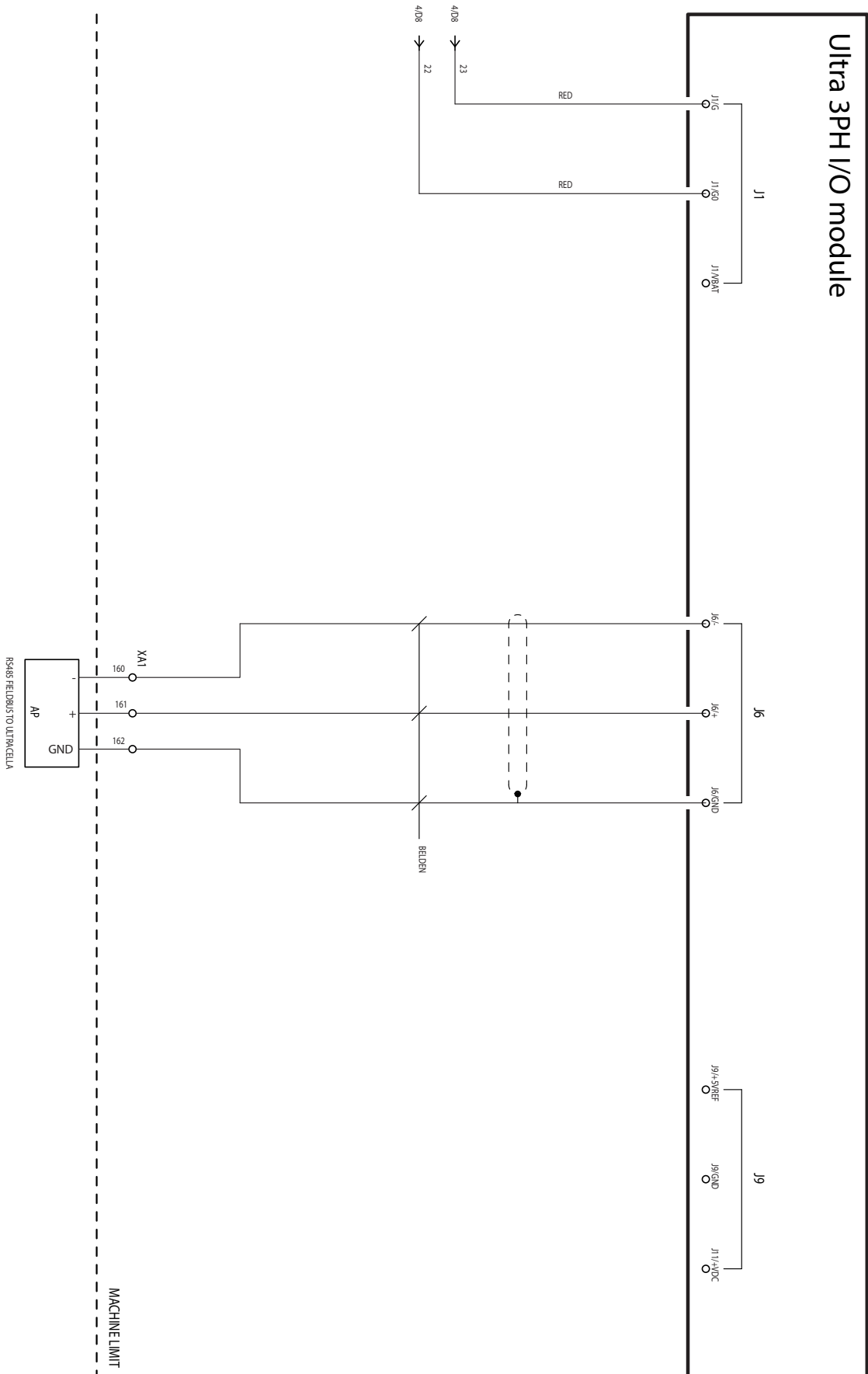


Fig. 10.k

**10.2.6 Connection for Pump Down thermostat working**

Connections for pump down controlled by pressure, with compressor shutdown due to low pressure

If the pump down procedure needs to be performed, controlled by pressure via a pressure switch connected to the Ultra 3PH Full three-phase module rather than UltraCella, and the compressor shuts down due to low pressure, the connections are as shown in the following diagram.

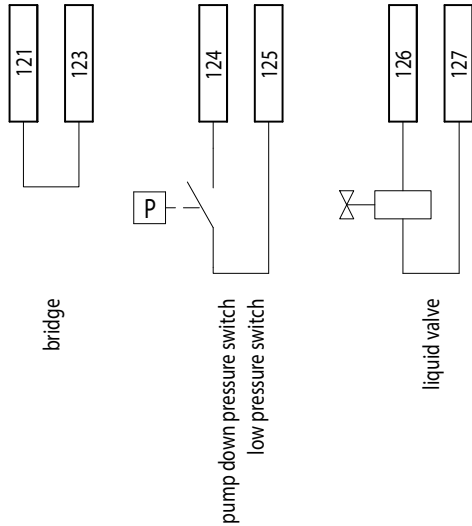


Fig. 9.e

With this configuration, when there is no cooling request from UltraCella ( $S_v < S_t$ ), the solenoid valve (terminals 126-127) opens, while the compressor (KM3) remains on until the pressure switch measures the low pressure threshold (TK1, terminals 124-125).

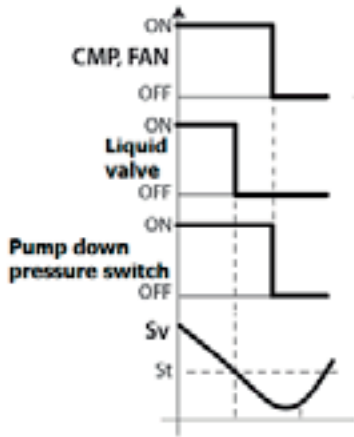


Fig. 9.f

**Note:** as the pressure switch is connected to the Ultra 3PH Full three-phase module, do not enable pump down on UltraCella (set  $c7=0$ ,  $H1 \neq 5$ ,  $H5 \neq 5$ ).

Connections for pump down controlled by pressure, with simultaneous activation of the compressor and solenoid valve

If the pump down procedure needs to be performed, controlled by pressure via a pressure switch connected to the Ultra 3PH Full three-phase module rather than UltraCella, with simultaneous activation and deactivation of the compressor and solenoid valve, the connections are as shown in the following diagram.

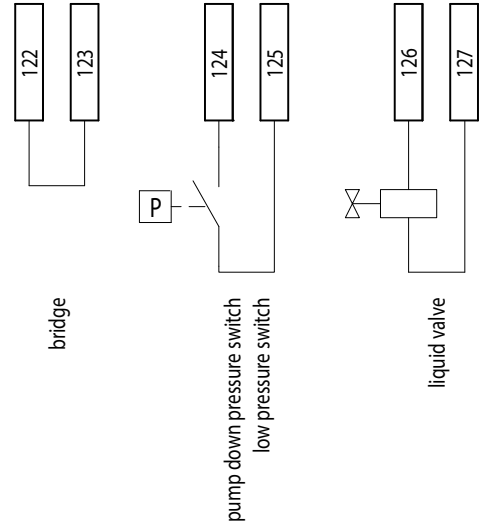


Fig. 9.g

With this configuration, when there is no cooling request from UltraCella ( $S_v < S_t$ ), the solenoid valve (terminals 126-127) and the compressor (KM3) are simultaneously deactivated. In normal operation, when the pressure switch measures the low pressure threshold, the compressor is shut down.

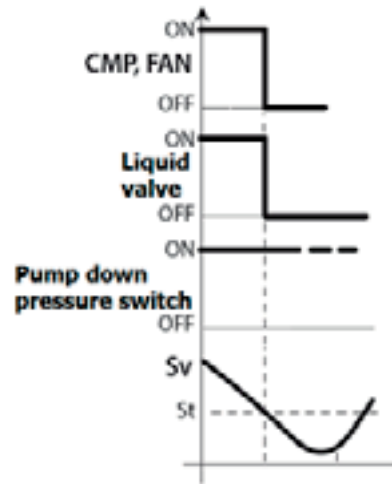


Fig. 9.h

**Nota:** Do not enable pump down on UltraCella (set  $c7=0$ ,  $H1 \neq 5$ ,  $H5 \neq 5$ ).

**Connections for pump down with simultaneous activation of the compressor and solenoid valve**

If the pump down procedure needs to be performed, with simultaneous activation and deactivation of the compressor and solenoid valve and without a pressure switch, the connections are as shown in the following diagram.

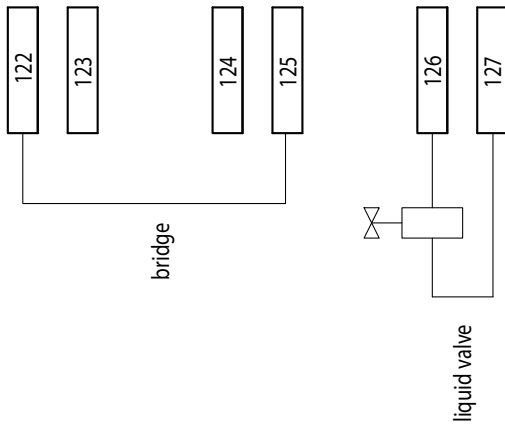


Fig. 9.i

With this configuration, when there is no cooling request from UltraCella ( $S_v < S_t$ ), the solenoid valve (terminals 126-127) and the compressor (KM3) are simultaneously deactivated.

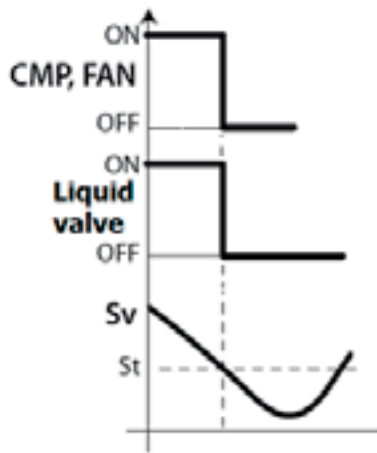


Fig. 9.j

**Nota:** Do not enable pump down on UltraCella (set  $c7=0$ ,  $H1 \neq 5$ ,  $H5 \neq 5$ ).

**Connections for timed pump down**

If the pump down procedure needs to be performed based on a time setting, with the solenoid valve connected to the Ultra 3PH Full three-phase module rather than UltraCella, the connections are as shown in the following diagram.

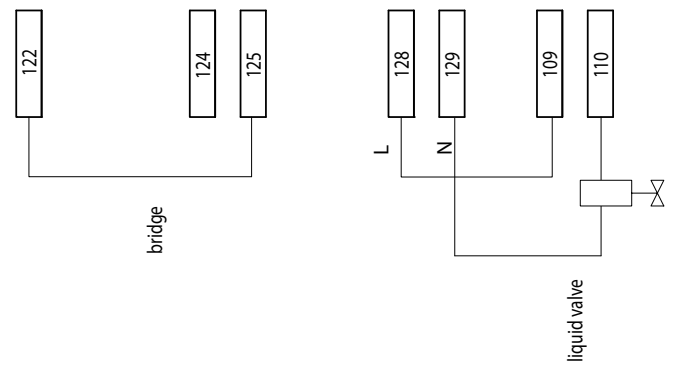


Fig. 9.k

On UltraCella, configure:

- $H1 = 5$  (output AUX1, terminals 109-110, for pump down valve)
- $c10 = 1$  (timed pump down)
- $c7 > 0$  (pump down time)

With this configuration, when there is no cooling request from UltraCella ( $S_v < S_t$ ), the solenoid valve (terminals 109-110, output AUX1 on UltraCella) opens, while the compressor (KM3) remains on for the time defined by parameter  $c7$

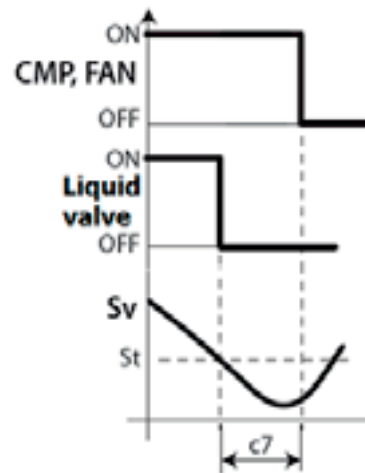


Fig. 9.l

10.2.7 Terminal units

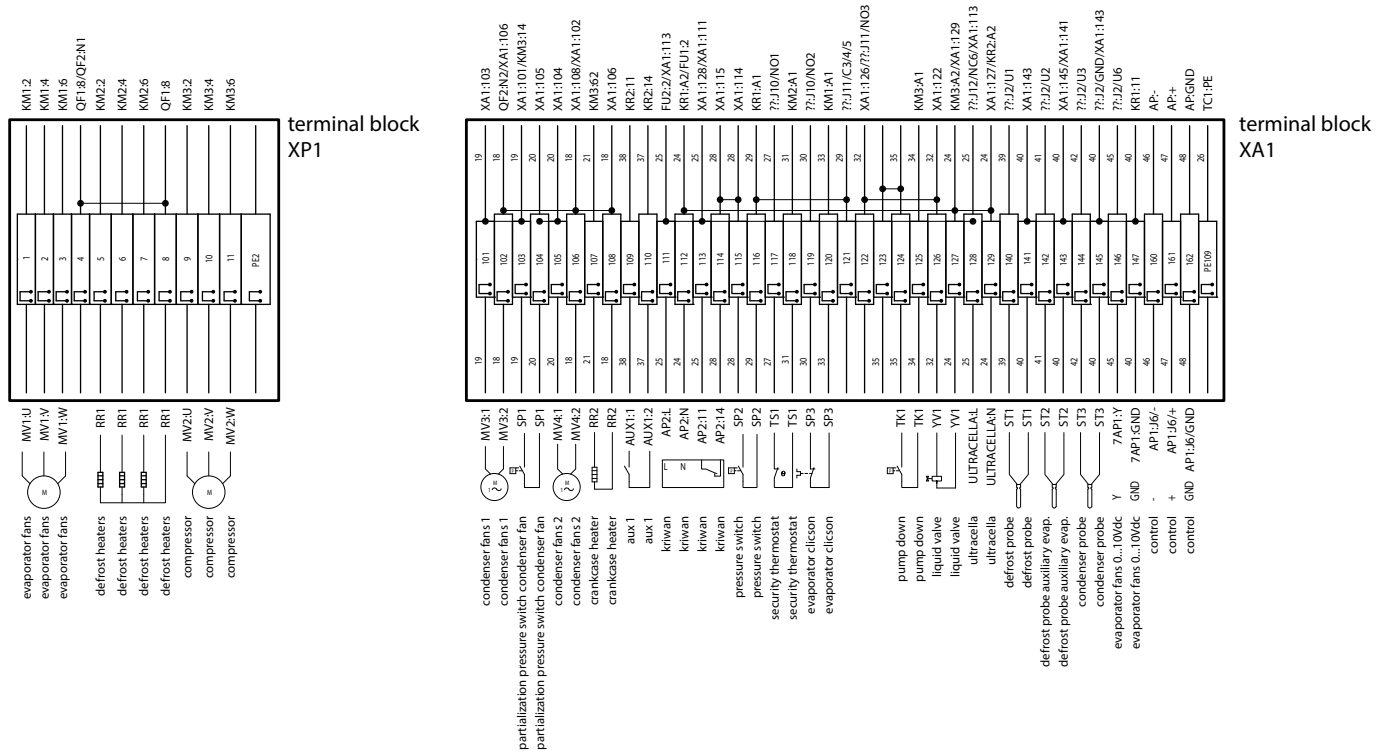


Fig. 10.I

Term.	Number and description	Note	
XP1	1	Evaporator fans	
	2		
	3		
	5	Defrost heaters	
	6		
	7		
	8	Compressor	
9			
10			
	PE2	Ground terminal	
XA1	101	Condensing fans 1	
	102	Condensing fans 1	
	103	Pressure switch condensing fans partialization	
	104		
	105	Condensing fans 2	
	106		
	107	Oil compressor heater (Carter)	
	108	UX1 relay	
	109		
	110		
	111		
	112	Kriwan	
	113		
	114		
	115	High/low Pressure switch	
	116		
	117	Safe thermostat evaporator fans	Normally closed. If active (open), evaporator fans are off and it's not notified in UltraCella
	118		
	119	Clicson evaporator fans	Normally closed. If active (open), evaporator fans are off and it's not notified in UltraCella
	120		
	124	Pump Down	
125	Solenoid valve		
126	Power supply 230Vac for UltraCella	To supply UltraCella	
127			
128	Defrost probe NTC		
129			
140	Defrost probe NTC aux evaporator		
141			
142	0...10V for evaporator fans (signal)		
143			
146	0...10V for evaporator fans (GND)		
147			
160	RS485 -	Connection RS485 Fieldbus to UltraCella	
161	RS485 +		
162	RS485 GND		
	PE109	Ground terminal	

## 11. SOFTWARE RELEASE

### 11.1 Software release table

Manual release	Availability date	Functions	UltraCella Software release	Notes		
1.1	28/02/2014	Basic cold room management: compressor, defrost, evaporator fans, light, 2xAUX relays	1.1	UltraCella single digit display		
		Single digit display management				
		Commissioning UltraCella through both built-in LED display and pGD1 UltraCella Service				
		Commissioning through wizard on pGD1				
		Upload/Download parameters via USB key				
		Defrost schedule by RTC				
		HACCP alarms				
		Maximum and minimum temperature recording				
		Diagnosis: I/O status visualization				
		Second step compressor with automatic rotation				
		Evaporator fans in PWM mode (on/off) with compressor off				
		Auxiliary evaporator management				
		Smart light management by door switch				
		Bowl heater activation				
		Condenser fan activation by temperature				
		Pump down management				
		Humidity probe reading				
Pre-charged configurations (recipes)						
Software update through pGD1						
1.3	30/06/2014	Double digit display management	1.2	UltraCella double digit display (software release 1.2) availability in production: 11/04/2014		
		Data logging function (one temperature)				
		Humidity ON/OFF output				
		Serial connection UltraCella - EVD EVO (only "start command")				
		Service menu on pGD1 (diagnosis)				
		Navigation improvements on both LED and pGD1	1.3	UltraCella software 1.3 availability in production: 30/06/2014		
		Added alarm indication on USB functions (in case of bad working)				
		Commissioning EVD EVO via UltraCella				
		Defrost by dl (fixed interval time) enable with RTC defrost set too				
		Limit and default parameter setting change (H0, /t2, dd, Fd)				
		0...10V output for variable speed evaporator fans				
		"Bugfixing: Input B5 Humidity reading High/low temp. alarm delay EVD communication in manual OFF status"			1.4	UltraCella software 1.4 availability in production: 03/11/2014
1.5	30/01/2015	3PH expansion module management (one to one)	1.5	UltraCella software 1.5 availability in production: 22/12/2014		
		Data logging: 2 selectable temperatures, variable sampling time				
		Log of stored alarms				
		BMS serial line: Modbus / Carel protocols selectable				
		Software update by built-in LED display				
		Addition of pGD texts in German and French				
		New default /A2=1 (defrost probe configured in B2)				
		New default settings for EVD module (push from UltraCella)				
		Door switch disabling (new question in wizard and new parameter A3)				

1.6	31/10/2015	0 to 10V output for variable speed condenser fans managed by pressure/temperature + floating condensing) algorithm	1.6	UltraCella software 1.6 availability in production: 27/07/2015
		Heating/cooling control with dead band		
		EVDice configuration from UltraCella		
		Generic functions		
		Auxiliary output activation by time bands		
		Set point variation by time bands / from digital input		
		Set point ramps		
		Humidity data logging		
		High / low humidity alarm management		
		Possibility to disable alarms Ed1 / Ed2 (parameter A8)		
		Additional pGD texts in Spanish		
		Alarms on high/low humidity levels		
		AUX1/AUX2 icon on active display when corresponding relay output active		
PMU variable (% valve opening in manual mode for EVD EVO) visible on built-in LED display				
1.7	07/01/2016	Improved EVDice management: management of signatures to protect custom configurations	1.7/1.8	UltraCella software 1.7 availability in production: 20/11/2015
		Configuration of BMS serial parameters		
		Language selection as first question in wizard		
		Addition of EVD EVO MOP parameters on UltraCella LED display		
		New default configuration for communication between UltraCella and 3PH modules		
		Door microswitch disabled by default (A3=1)		
		Parameter IPE (enable EVDice communication with UltraCella) available on supervisor		
2.0	31/03/2017	Compatibility with new refrigerants	1.9 / 2.0	UltraCella software release 2.0 availability in production: 30/01/2017
		Humidity, humidification and dehumidification management		
		Improved heating management		
		Implementation of serious alarm SA		
		Improved fan management		
		Output (relay) configuration		
		Smooth lines & floating suction		
		Third generic ON/OFF function added		

Tab. 11.a





# CAREL

**CAREL INDUSTRIES S.p.A.**

Via dell'Industria, 11 - 35020 Brugine - Padova (Italy)

Tel. (+39) 049.9716611 - Fax (+39) 049.9716600

e-mail: [carel@carel.com](mailto:carel@carel.com) - [www.carel.com](http://www.carel.com)

Agenzia / Agency: