

**Copeland Scroll™**

## Application Guidelines

Scroll™ Compressors for R290 applications  
ZB12KCU to ZB49KCU



<b>About these guidelines .....</b>	<b>1</b>
<b>1 Safety instructions .....</b>	<b>1</b>
1.1 Icon explanation .....	1
1.2 Safety statements .....	2
1.3 General instructions .....	2
<b>2 Product description .....</b>	<b>4</b>
2.1 Common information about Copeland Scroll™ compressors.....	4
2.2 Nomenclature.....	4
2.3 Application .....	5
2.3.1 <i>Qualified refrigerant and oil</i> .....	5
2.3.2 <i>Maximum allowable pressures</i> .....	5
2.3.3 <i>Application limits and operating envelopes</i> .....	5
2.3.4 <i>Dimensions – ZB12KCU to ZB20KCU</i> .....	6
2.3.5 <i>Dimensions – ZB25KCU to ZB49KCU</i> .....	7
<b>3 Installation .....</b>	<b>9</b>
3.1 Compressor handling.....	9
3.1.1 <i>Transport and storage</i> .....	9
3.1.2 <i>Positioning and securing</i> .....	9
3.1.3 <i>Installation location</i> .....	9
3.1.4 <i>Compressor mounting parts</i> .....	10
3.2 Brazing procedure.....	10
3.2.1 <i>General brazing procedure</i> .....	10
3.2.2 <i>Brazing procedure for ZB*KCU compressors in parallel applications</i> .....	11
3.3 Suction accumulators.....	11
3.4 Filter screens .....	12
3.5 Sound shell .....	12
3.6 Insulation material.....	12
3.7 Sound and vibration .....	13
<b>4 Electrical connection .....</b>	<b>14</b>
4.1 General recommendations.....	14
4.2 Electrical installation .....	14
4.2.1 <i>Terminal box</i> .....	15
4.2.2 <i>Motor windings</i> .....	18
4.2.3 <i>Protection devices</i> .....	18
4.2.4 <i>Crankcase heaters</i> .....	18
4.3 Pressure protection devices .....	18
4.3.1 <i>High-pressure protection</i> .....	18
4.3.2 <i>Low-pressure protection</i> .....	18
4.3.3 <i>Internal pressure relief valve</i> .....	19
4.4 Discharge gas temperature protection.....	19

# Copeland Scroll™

4.4.1	Excessive discharge gas temperatures .....	19
4.4.2	Discharge gas temperature protection .....	20
4.4.3	Assembly of external discharge gas temperature protection .....	20
4.5	Motor protection .....	20
4.6	High-potential testing .....	20
<b>5</b>	<b>Starting up &amp; operation.....</b>	<b>21</b>
5.1	Strength-pressure test .....	21
5.2	Compressor tightness test .....	21
5.3	System evacuation.....	22
5.4	Preliminary checks – Pre-starting .....	22
5.5	Charging procedure .....	22
5.6	Run-in time.....	23
5.7	Initial start-up .....	23
5.8	Rotation direction .....	23
5.9	Starting sound.....	24
5.10	Deep vacuum operation.....	24
5.11	Shell temperature.....	24
5.12	Pump down cycle .....	24
5.13	Minimum run time .....	24
5.14	Shut-off sound.....	25
5.15	Supply frequency and voltage .....	25
5.16	Oil level .....	25
<b>6</b>	<b>Maintenance &amp; repair .....</b>	<b>27</b>
6.1	Disassembling system components .....	27
6.2	Exchanging the refrigerant.....	28
6.3	Replacing a compressor .....	28
6.3.1	Compressor replacement.....	29
6.3.2	Start-up of a new or replacement compressor.....	29
6.3.3	Compressor return procedure .....	30
6.4	Lubrication and oil removal .....	30
6.5	Oil additives .....	31
<b>7</b>	<b>Troubleshooting.....</b>	<b>32</b>
<b>8</b>	<b>Dismantling &amp; disposal.....</b>	<b>35</b>
<b>9</b>	<b>References.....</b>	<b>35</b>
	<b>DISCLAIMER .....</b>	<b>35</b>

## About these guidelines

The purpose of these application guidelines is to provide guidance in the application of Copeland Scroll™ ZB\*KCU compressors. They are intended to answer the questions raised while designing, assembling and operating a system with these products.

Besides the support they provide, the instructions listed herein are also critical for the proper and safe functioning of the compressors. Emerson Climate Technologies will not guarantee the performance and reliability of the product if it is misused in regard of these guidelines.

These application guidelines cover stationary applications only. For mobile applications, contact Application Engineering as other considerations may apply.

## 1 Safety instructions

Copeland Scroll compressors are manufactured according to the latest relevant European safety standards. Particular emphasis has been placed on the user's safety.

The ZB\*KCU compressors are intended for installation in systems according to the Machinery Directive MD 2006/42/EC, to the Pressure Equipment Directive PED 97/23/EC and to the ATEX Directive 94/9/EC for Zone 2.

In order to keep the system compliant with the ATEX Directive 99/92/EC, all accessories to be fitted on the compressor, eg, oil level regulator, crankcase heater, discharge line thermostat, shall comply with the ATEX Directive 94/9/EC Zone 2. If one of these accessories does not comply, the complete system will lose its compliance with the ATEX Directive 99/92/EC.









The ZB\*KCU compressors can only be installed in the EU if they have been installed in systems according to instructions and conform to the corresponding provisions of legislation. Conformity to local regulations must also be observed. For relevant standards please refer to the Manufacturer's Declaration, available at [www.emersonclimate.eu](http://www.emersonclimate.eu).

The Material Safety Datasheet (MSDS) for R290 shall be considered when working with this type of refrigerant - please check this document provided by the gas supplier.

These instructions shall be retained throughout the lifetime of the compressor.

**You are strongly advised to follow these safety instructions.**

### 1.1 Icon explanation

 <p><b>WARNING</b> This icon indicates instructions to avoid personal injury and material damage.</p>	 <p><b>Risk of fire</b> This icon indicates a flammable ambient.</p>
 <p><b>High voltage</b> This icon indicates operations with a danger of electric shock.</p>	 <p><b>CAUTION</b> This icon indicates instructions to avoid property damage and possible personal injury.</p>
 <p><b>Danger of burning or frostbite</b> This icon indicates operations with a danger of burning or frostbite.</p>	 <p><b>IMPORTANT</b> This icon indicates instructions to avoid malfunction of the compressor.</p>
 <p><b>Explosion hazard</b> This icon indicates operations with a danger of explosion.</p>	<p><b>NOTE</b> This word indicates a recommendation for easier operation.</p>
 <p><b>Danger of explosive atmosphere</b> This icon indicates an explosive atmosphere or explosive gas mixture.</p>	

# Copeland Scroll™

## 1.2 Safety statements

- Refrigeration compressors must be employed only for their intended use. The refrigeration system has to be labelled according to the applicable standards and legislation.
- Only qualified and authorized HVAC or refrigeration personnel are permitted to install commission and maintain this equipment. Only competent personnel (EN 13313) qualified for flammable refrigerant handling is permitted to commission, initiate and maintain the compressor/refrigeration systems; the user is not allowed to do so and needs to call an expert.
- If an explosive atmosphere is detected, immediately stop the compressor and/or de-energize the power supply of the compressor/refrigeration system (EN 378).
- Electrical connections must be made by qualified electrical personnel.
- All valid standards for connecting electrical and refrigeration equipment must be observed.
- The national legislation and regulations must be observed.



**Use personal safety equipment.** Safety goggles, gloves, protective clothing, safety boots and hard hats should be worn where necessary.

## 1.3 General instructions



### WARNING

**Open flame in a potentially explosive atmosphere! Fire hazard!** Open flames and smoking are strictly forbidden at all times. Continuously check if the ambient atmosphere is non explosive.

During service make sure that:

- the area is well ventilated;
- the materials and equipment used are suitable for use under explosive conditions;
- only non-sparking tools are used;
- antistatic gloves and clothes are used;
- build-up of electrostatic charges is avoided.

In case of explosive atmosphere:

- immediately stop the compressor and/or de-energize the power supply of the compressor and any other electrical component/equipment, eg, crankcase heater;
- no unshielded flame is allowed.

Furthermore, before opening the refrigeration system or working on it with an unshielded flame:

- continuously check if the ambient atmosphere is non explosive and ensure proper ventilation of the room before creating any naked flame; no naked flame is allowed in an explosive atmosphere;
- if the atmosphere reaches a dangerous concentration of flammable gas, avoid any ignition source and ventilate the room further;
- if parts of the refrigeration system are charged with flammable refrigerant, be sure that all the valves are tightly closed and that the open pipes after the valves are free of refrigerant and oil.





### WARNING

**Air/R290 mixture! Potentially explosive atmosphere!** R290 mixed with air can create an explosive atmosphere. If an explosive atmosphere is detected, immediately stop the compressor and ventilate the room. No open flame is allowed.

- 

**WARNING**  
**Electrical shock hazard! Serious personal injuries and/or system breakdown!** Allow drive components to electrically discharge for a minimum of two minutes before servicing. Use compressor with grounded system only. Screwed electrical connections must be used in all applications. Refer to original equipment wiring diagrams. Electrical connections must be made by qualified electrical personnel.
- 

**WARNING**  
**Pressurized system! Serious personal injuries and/or system breakdown!** Accidental system start before complete set-up must be avoided. Never leave the system unattended without locking it out electrically when it is on vacuum and has no refrigerant charge, when it has a holding charge of nitrogen, or when the compressor service valves are closed.
- 

**WARNING**  
**System breakdown! Personal injuries!** Only approved refrigerants and refrigeration oils must be used.
- 

**WARNING**  
**High shell temperature! Burning!** Do not touch the compressor until it has cooled down. Ensure that other materials in the area of the compressor do not get in touch with it. Lock and mark accessible sections.
- 

**CAUTION**  
**Overheating! Bearing damage!** Do not operate compressor without refrigerant charge or without it being connected to the system.
- 

**CAUTION**  
**Contact with POE! Material damage!** POE lubricant must be handled carefully and the proper protective equipment (gloves, eye protection, etc.) must be used at all times. POE must not come into contact with any surface or material that it might damage, including without limitation, certain polymers, eg, PVC/CPVC and polycarbonate.
- 

**IMPORTANT**  
**Transit damage! Compressor malfunction!** Use original packaging. Avoid collisions and tilting.

# Copeland Scroll™

## 2 Product description

### 2.1 Common information about Copeland Scroll™ compressors

The Scroll compressor has been under development at Emerson Climate Technologies since 1979. It is the most efficient and durable compressor Emerson Climate Technologies has ever developed for air conditioning, refrigeration and heating applications.

**These application guidelines deal with all vertical single Copeland Scroll compressors from ZB12KCU to ZB49KCU.**

Compressor	Cooling capacity kW	Motor
ZB12KCU	2.82	TFMN
ZB17KCU	3.93	TFMN
ZB20KCU	4.99	TFMN
ZB25KCU	5.73	TFMN
ZB31KCU	7.05	TFMN
ZB37KCU	8.41	TFMN
ZB49KCU	10.32	TFMN

*Evaporating temperature: -10°C; Condensing temperature: 45°C; Suction gas superheat: 10K; Liquid sub-cooling: 0K, Frequency: 50 Hz*

These compressors have one Scroll compression set driven by a three-phase induction motor. The Scroll set is mounted at the upper end of the rotor shaft of the motor. The rotor shaft axis is in the vertical plane.

### 2.2 Nomenclature

The model designation contains the following technical information about the standard compressors:

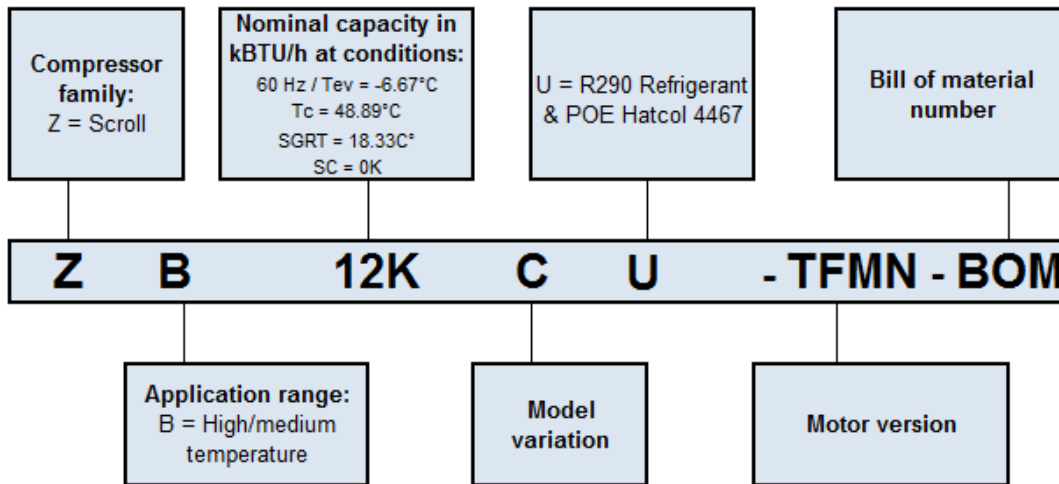

The compressor label conforms to the ATEX Directive 94/9/CE specifications and to the harmonized standard series EN 60079. The ATEX marking for applications in gas explosive atmosphere Zone 2 locations is as follows:

- ATEX Directive 94/9/EC part:  II 3G
- Standard (EN 60079-0, EN 60079-15) part: **Ex nA IIA T2**

The Declaration of Conformity is available from the manufacturer upon request.

## 2.3 Application

### 2.3.1 Qualified refrigerant and oil

Compressors	ZB12KCU to ZB49KCU
Qualified refrigerant	R290
Copeland brand products standard oil	Hatcol 4467 (Ident Number 8410785)
Servicing oil	Hatcol 4467 (Ident Number 8410785)

Table 1: Qualified refrigerant and oil

Oil recharge values can be taken from Copeland Scroll compressors brochures or Copeland™ brand products Select software at [www.emersonclimate.eu](http://www.emersonclimate.eu).

**NOTE:** A link to more information about qualified oils and refrigerants in Copeland compressors can be found in Chapter 9 “References”.

### 2.3.2 Maximum allowable pressures

The maximum allowable pressures (PS) are the pressure values at the high- and low-pressure sides up to which it is safe to operate the compressor. Safety is established in compliance with the relevant standards applicable to the given product.

Compressor	PS High-pressure side	PS Low-pressure side
ZB12KCU to ZB49KCU	28 bar(g)	17 bar(g)

Table 2

### 2.3.3 Application limits and operating envelopes



#### CAUTION

**Operation outside application envelope! Compressor breakdown!** Never allow compressor to operate outside the application envelope. Copeland Scroll compressors are qualified for operation inside the envelope published by Emerson Climate Technologies. The envelope is defined according to Emerson Climate Technologies testing and experience. Operating a compressor outside the envelope might lead to compressor failure which would be the heat pump / refrigeration / air conditioning manufacturer’s responsibility. The superheat at the compressor suction inlet must always be sufficient to ensure that no refrigerant droplets enter the compressor. **For a typical evaporator-expansion valve configuration a minimum stable superheat of at least 10K is required.** In the same manner, the superheat at the compressor suction must always stay below a maximum limit specified by Emerson Climate Technologies, depending on the model and for which the operating envelope is defined.

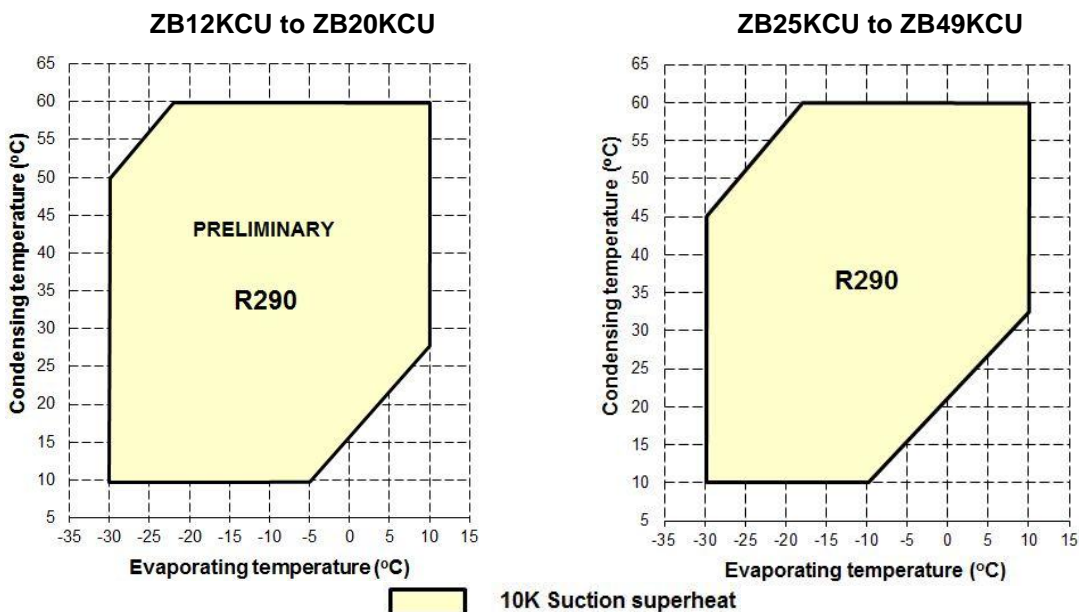

Figure 1: Application envelopes for compressors ZB12KCU to ZB49KCU with R290



# Copeland Scroll™

**NOTE:** These application envelopes are for R290 only. Please also refer to Copeland brand products Select software.

## 2.3.4 Dimensions – ZB12KCU to ZB20KCU

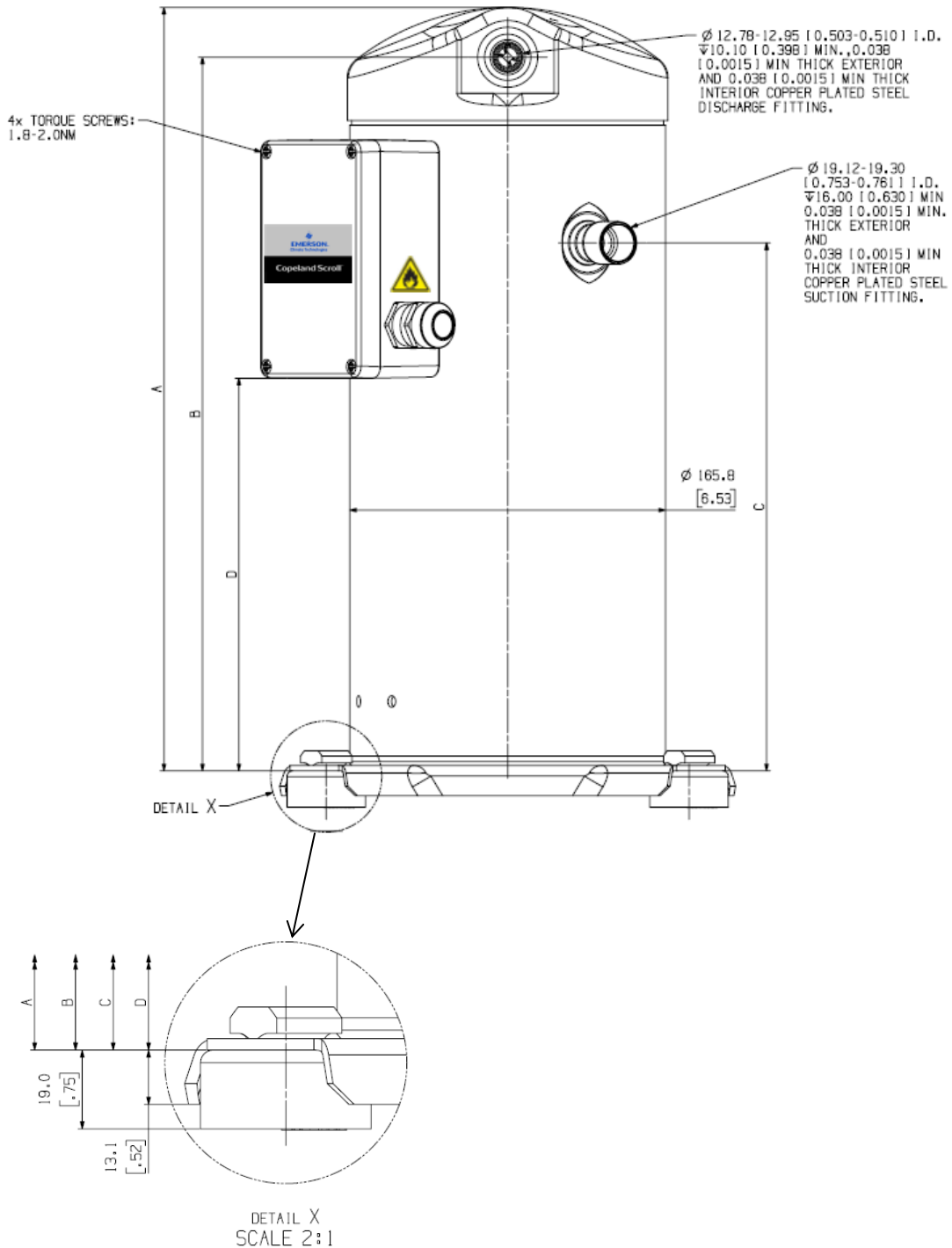

Model	A ± 3.0*	B*	C*	D ± 3.0*
ZB12KCU-TFMM	364.4 [14.35]	338.3 [13.32]	244.5 [9.62]	173.5 [6.83]
ZB17KCU-TFMM	387.0 [15.24]	360.9 [14.21]	264.4 [10.41]	193.4 [7.61]
ZB20KCU-TFMM	400.8 [15.78]	374.6 [14.75]	277.1 [10.91]	206.1 [8.12]

\* Dimensions in mm [inches]

Table 3: Compressor grommet dimensions

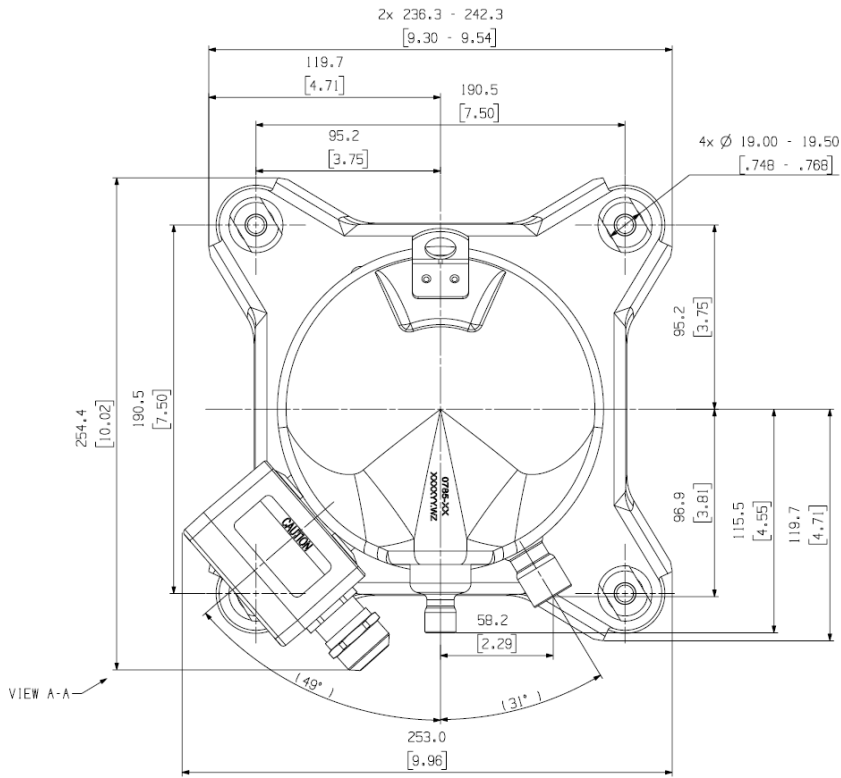

### 2.3.5 Dimensions – ZB25KCU to ZB49KCU

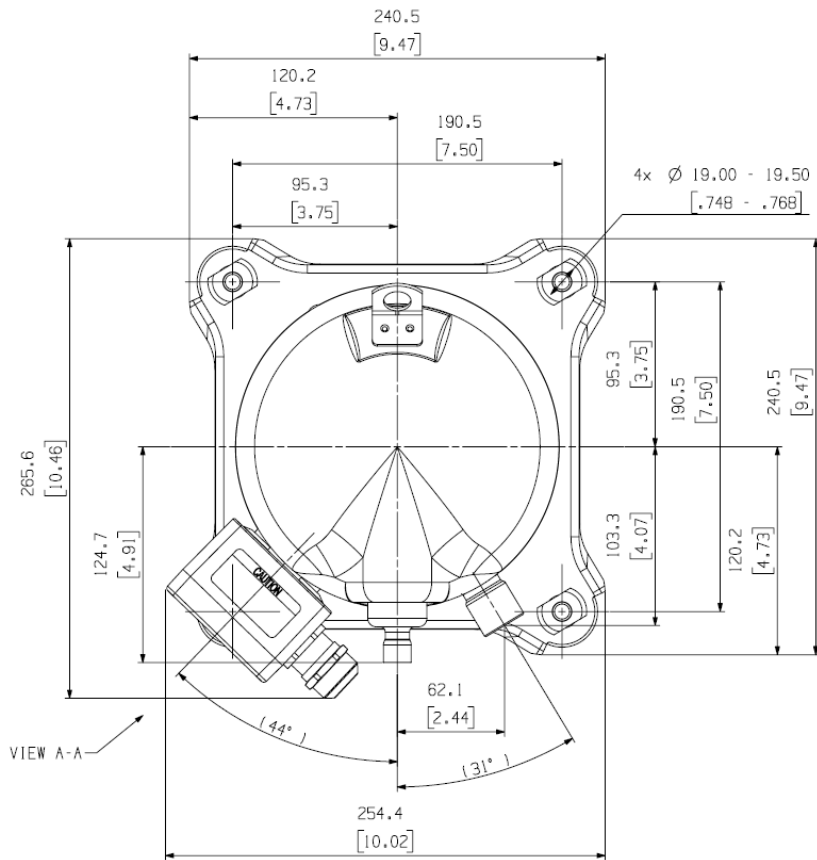

Safety  
instructions

Product  
description

Installation

Electrical  
connection

Starting up &  
operation

Maintenance &  
repair

Trouble-  
shooting

Dismantling &  
disposal

References

# Copeland Scroll™

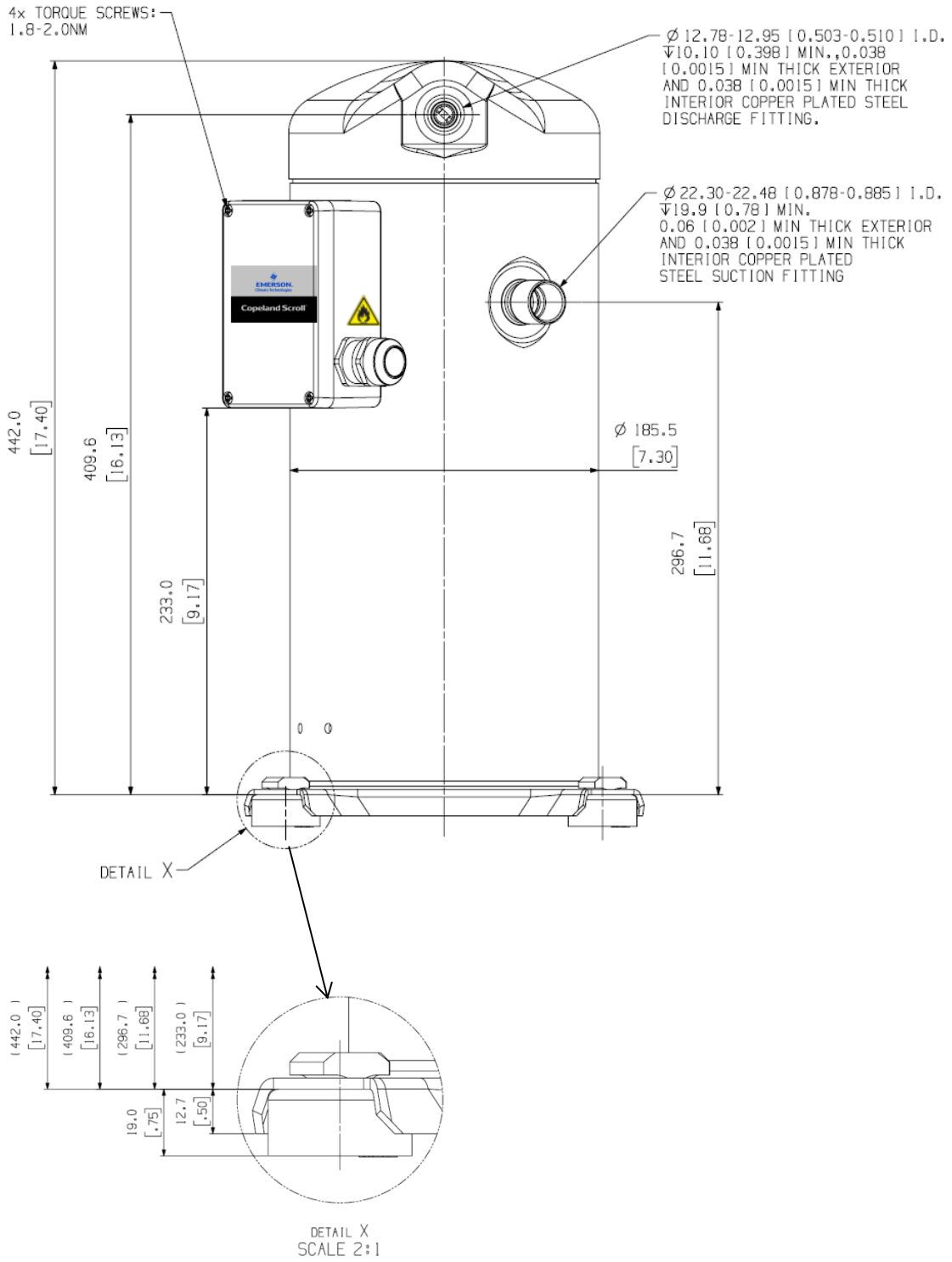

## 3 Installation



### WARNING

**High pressure! Injury to skin and eyes possible!** Be careful when opening connections on a pressurized item.

### 3.1 Compressor handling

#### 3.1.1 Transport and storage



### WARNING

**Risk of collapse! Personal injuries!** Move compressors only with appropriate mechanical or handling equipment according to weight. Keep in the upright position. Stack pallets on top of each other when not exceeding 300 kg. Do not stack single boxes on top of each other. Keep the packaging dry at all times.

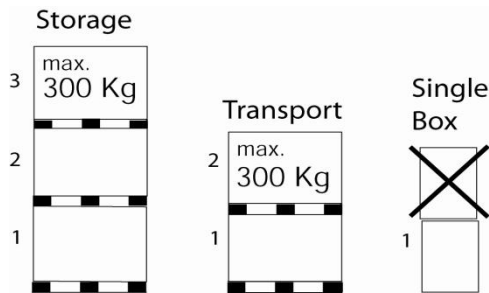

Figure 2

The compressor tilt angle should not be more than 30° during transport and handling. This will prevent oil from exiting through the suction stub. A tilt angle of maximum 45° is allowed for a very short time. Tilting the compressor more than 45° might affect its lubrication at start-up.

**NOTE: The compressor is pre-charged with dry air to avoid any moisture contamination.**

#### 3.1.2 Positioning and securing



### IMPORTANT

**Handling damage! Compressor malfunction!** Only use the lifting eyes whenever the compressor requires positioning. Using discharge or suction connections for lifting may cause damage or leaks.

The compressor should be kept vertical during handling.

The discharge connection plug should be removed first before pulling the suction connection plug to allow the dry air pressure inside the compressor to escape. Pulling the plugs in this sequence prevents oil mist from coating the suction tube making brazing difficult. The copper-coated steel suction tube should be cleaned before brazing.

The plugs must be removed as late as possible before brazing so that the air humidity does not affect the oil characteristics.

As oil might spill out of the suction connection located low on the shell, the suction connection plug must be left in place until the compressor is set into the unit.

No object, eg, a swaging tool should be inserted deeper than 51 mm into the suction tube or it might damage the suction screen and motor.

#### 3.1.3 Installation location

These compressors shall be installed in Zone 2 locations, as defined by the ATEX directive, or in non-hazardous atmosphere.

Scroll compressors are capable of operating correctly in ambient humidity from 30% to 95% and at altitudes up to 1000 meters. For correct operation the ambient air temperature must range from -35°C to 50°C and the compressor maximum operating pressure PS shall be respected at all times during operation and at standstill.

# Copeland Scroll™

Ensure the compressors are installed on a solid level base. For single compressor applications, the compressor tilt angle during operation should not be more than 15° to allow adequate lubrication. For multiple compressor parallel configurations, the compressors must be positioned completely vertically on a totally horizontal surface or rail.

## 3.1.4 Compressor mounting parts

The compressors are designed to be mounted on vibration absorber grommets. The grommets dampen the start-up surge of the compressor and minimise sound and vibration transmission to the compressor base during operation. The metal sleeve inside is a guide designed to hold the grommet in place. It is not designed as a load-bearing member, and application of excessive torque to the bolts can crush the sleeve. Its inner diameter is approximately 8.5 mm to fit, eg, an M8 screw. The mounting torque should be  $13 \pm 1$  Nm. It is critically important that the grommet is not compressed.

If the compressors are mounted in tandem or used in parallel, then the hard mountings (bolt M9 5/16") are recommended. The mounting torque should be  $27 \pm 1$  Nm. It is possible to deliver these hard mounting parts as a kit, or on request to deliver the compressor with these parts instead of the rubber grommets.

**NOTE:** For more information please refer to Technical Information C7.11.2 "Scroll Mounting Parts".



Figure 3: Soft mounting parts

## 3.2 Brazing procedure



### WARNING

**High temperature! Burning!** Proceed with caution when brazing system components. Do not touch the compressor until it has cooled down. Ensure that other materials in the area of the compressor do not make contact.



### IMPORTANT

**Blockage! Compressor breakdown!** Maintain a flow of oxygen-free nitrogen through the system at very low pressure during brazing. Nitrogen displaces the air and prevents the formation of copper oxides in the system. If allowed to form, the copper oxide material can later be swept through the system and block screens such as those protecting capillary tubes, thermal expansion valves, and accumulator oil return orifices.

**Contamination or moisture! Bearing failure!** Do not remove the connection plugs until the compressor is set into the unit. This minimises any entry of contaminants and moisture.

### 3.2.1 General brazing procedure

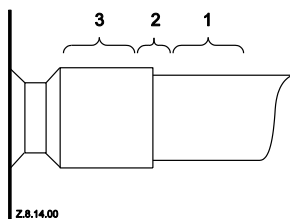

Figure 4: Tube connecting areas

Copeland Scroll compressors have copper-plated steel suction, injection and discharge tubes. These tubes are far more robust and less prone to leaks than copper tubes. Due to the different thermal properties of steel and copper, brazing procedures may have to be changed from those commonly used.

**Figure 4** shows the proper procedure for brazing the suction and discharge lines to a Scroll compressor.

- The copper-coated steel tubes on Scroll compressors can be brazed in approximately the same manner as any copper tube.
- Recommended brazing material: any Silfos material is recommended, preferably with a minimum of 5% silver. However, 0% silver is acceptable.
- Be sure tube fitting inner diameter and tube outer diameter are clean prior to assembly.
- Using a double-tipped torch, apply heat in area 1.
- As the tube approaches brazing temperature, move the torch flame to area 2.
- Heat area 2 until braze temperature is attained, moving the torch up and down and rotating around the tube as necessary to heat the tube evenly. Add braze material to the joint while moving the torch around the joint to flow braze material around the circumference.
- After the braze material flows around the joint, move the torch to heat area 3. This will draw the braze material down into the joint. The time spent heating area 3 should be minimal.
- As with any brazed joint, overheating may be detrimental to the final result.

**NOTE:** Since the discharge stub contains a check valve, care must be taken not to overheat it to prevent brazing material from flowing into it.

### 3.2.2 Brazing procedure for ZB\*KCU compressors in parallel applications

For ZB\*KCU compressors in parallel applications, additional precautions shall be taken before brazing the oil and gas equalization ports. The sequence shall be as follows:

First, install the compressors on the base frame and tilt the assembly so that oil will not be lost when opening the cap. The oil equalization line assembly should be ready for brazing at this point.

Next, release the protective gas charge: the rubber plug from the discharge port of the compressor has to be removed first, then the rubber plug from the oil port.

Most probably the oil port will be coated with some oil. It is mandatory to clean out the oil before brazing. If the inner surface is contaminated with oil the brazing material will not adhere to the surface and the joint will fail, generating leakage. The oil should be carefully wiped out with industrial absorption paper. Industrial solvents on a clean cloth can be used too but only with great care. Note that emery cloth will not remove the oil.

It is possible that the oil cannot be completely cleaned out. In this case additional measures should be taken. For instance, if a connection is coated with flux then when brazing the residual oil will be removed due to the applied heat.

If an oil level control is to be used, eg, Alco Controls OM3, please refer to the product documentation when brazing the adaptor.

### 3.3 Suction accumulators



#### CAUTION

**Inadequate lubrication! Bearing and moving parts destruction!** Minimise liquid refrigerant returning to the compressor. Too much refrigerant dilutes the oil. Liquid refrigerant can wash the oil off the bearings and moving parts leading to overheating and compressor failure.

Irrespective of system charge, oil dilution may occur if large amounts of liquid refrigerant repeatedly flood back to the compressor during:

- normal off cycles
- defrost
- varying loads

Due to Copeland Scrolls inherent ability to handle liquid refrigerant in flooded start and defrost cycle operation, an accumulator is not required for durability in most systems. However, large volumes of liquid refrigerant repeatedly flooding back to the compressor during normal off cycles, or excessive liquid refrigerant flooding back during defrost or varying loads can dilute the oil, no matter what the system charge is. As a result, bearings and moving parts will be inadequately lubricated and wear may occur.

# Copeland Scroll™

To determine if the accumulator can be removed, dedicated tests must be carried out to ensure that excessive liquid does not flood back to the compressor during defrost or varying loads. The defrost test must be done at an outdoor ambient temperature of around 0°C in a high relative humidity environment. Liquid flood back must be monitored during reversing valve operation, especially when coming out of defrost. Excessive flood back occurs when the sump temperature drops below the safe operation line shown in **Figure 5**.

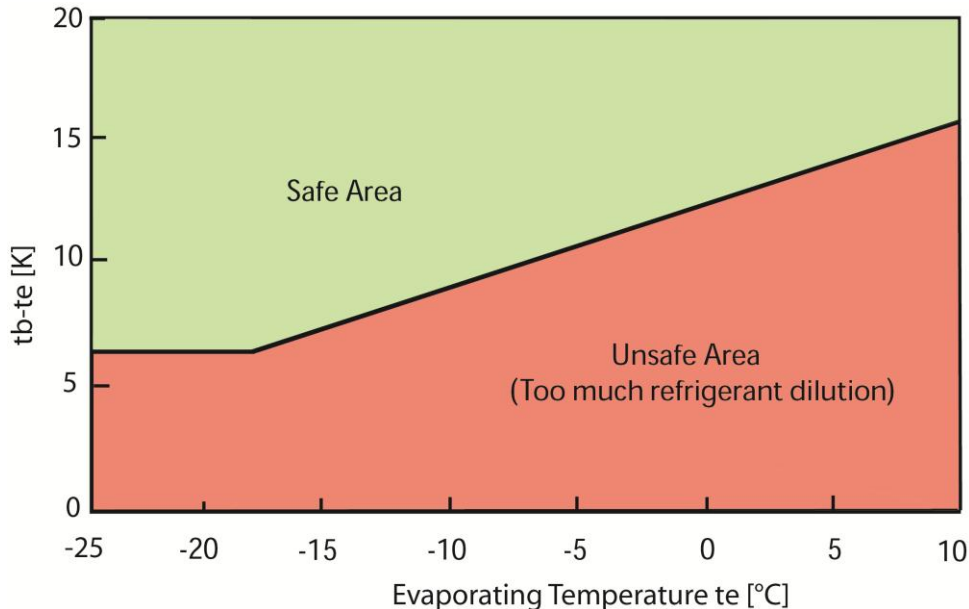

**Figure 5: Dilution chart for transient operation ( $t_b$  = bottom shell temp.;  $t_e$  = evaporating temp.)**

If an accumulator is used, the oil-return orifice should be from 1 to 1.4 mm in diameter for all ZB\*KCU models depending on compressor size and compressor flood back results. To protect this small orifice from plugging with system debris a large-area protective screen no finer than 30 x 30 mesh (0.6 mm openings) is required. Tests have shown that a small screen with a fine mesh can easily become plugged causing oil starvation to the compressor bearings.

The size of the accumulator depends upon the operating range of the system and the amount of sub-cooling and subsequent head pressure allowed by the refrigerant control. System modelling indicates that systems operating down to and below -18°C will require an accumulator that can hold around 70% to 75% of the system charge.

### 3.4 Filter screens



#### CAUTION

**Screen blocking! Compressor breakdown!** Use filter screens with at least 0.6 mm openings.

The use of filter screens finer than 30 x 30 mesh (0.6 mm openings) anywhere in the system should be avoided with these compressors. Field experience has shown that finer mesh screens used to protect thermal expansion valves, capillary tubes or accumulators can become temporarily or permanently plugged with normal system debris and block the flow of either oil or refrigerant to the compressor. Such blockage can result in compressor failure.

### 3.5 Sound shell

Presently no sound shell attenuation for ZB\*KCU compressors is available from Emerson Climate Technologies. If a sound shell is still needed, particular attention shall be paid to its non-electrostatic properties (see EN60079-0, clause 7.4).

### 3.6 Insulation material

In a system, insulation material is typically used to insulate the suction line, suction accumulator, expansion valve bulb or discharge line thermostat. When choosing the insulation material, particular attention shall be paid to its non-electrostatic properties (see EN60079-0, clause 7.4).

## 3.7 Sound and vibration



### WARNING

**Vibration! Creation of an explosive atmosphere!** Carefully check the system for vibrations.

Vibrations during compressor operation can cause cracks which could lead to refrigerant leakage. This situation must be avoided by the system manufacturer/installer. Therefore proper pipe design must be taken into consideration when connecting a scroll compressor to a system.

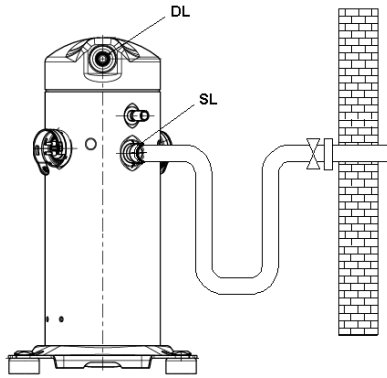

Figure 6: Suction tube design

A scroll compressor makes both a rocking and twisting motion and enough flexibility must be provided in the pipe-lines to allow starting, stopping and steady state running of the compressor without transmitting excessive stress into any line attached to the unit. In a split system, the most important goal is to ensure minimal vibration in all directions to avoid transmitting vibrations to the structure to which the lines are fastened.

Under some conditions, the Copeland Scroll has a normal starting rotational motion that can transmit a transient noise along the lines. This may be particularly pronounced in compressors using a three-phase motor due to their inherently higher starting torque. This phenomenon, like the one described previously, can easily be avoided by using standard line isolation techniques.

The sound level of a system is the result of design, quality and application. Scroll compressors sound power levels generally increase with the compressor model capacity and the condition pressure ratio.



## 4 Electrical connection

---

### 4.1 General recommendations

The compressor terminal box has a wiring diagram on the inside of its cover. Before connecting the compressor, ensure the supply voltage, the phases and the frequency match the nameplate data.

The electrical installation must be executed in compliance with standard EN 60204-1 and/or other standards and regulations of application when dealing with flammable refrigerants.

### 4.2 Electrical installation



#### **WARNING**

**Conductor cables! Electrical shock!** Shut off power supply before and between each test.



#### **WARNING**

**Conductor cables in a potentially explosive atmosphere! Fire hazard!** Shut off power supply before and between each test. Continuously check if the ambient atmosphere is non explosive and ensure proper ventilation before and when working on the electrical installation. With flammable or explosive atmosphere no work on the electrical installation is allowed. If the atmosphere reaches a dangerous concentration of flammable gas immediately stop any work on the electrical installation, avoid any source of ignition and ensure proper ventilation of the room.

**Sparking in a potentially explosive atmosphere! Explosion hazard!** The system capacitor may remain charged for a few minutes after shutdown. Before starting to work on the electrical installation make sure accidental sparking is not possible.

Recommended wiring diagrams are shown in figures hereunder.

**NOTE:** A contactor K2 has to be used for the safety chain to comply with EN 60335 and EN 60204-1.

**NOTE:** It is mandatory to install a residual current device (RCD) in any electrical system associated with ZB\*KCU compressors (see Figure 7).

## Three-phase compressors (TF\*) with internal motor protection:

For the ZB\*KCU range of compressors the following circuit diagrams must be used:

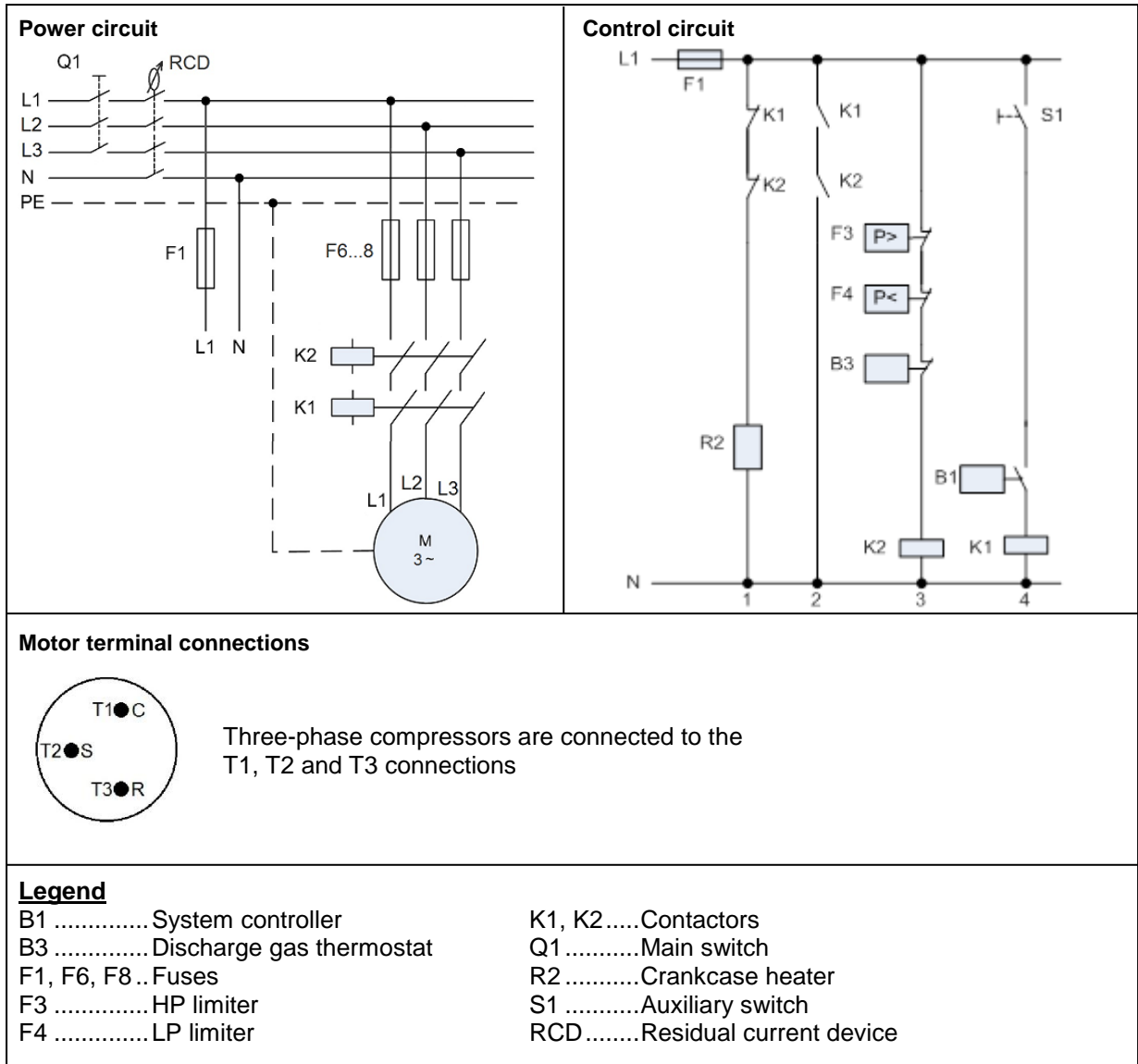

Figure 7

### 4.2.1 Terminal box

**WARNING**  
**Terminal box improperly closed in a potentially explosive atmosphere! Explosion hazard!** Avoid explosive atmosphere in the terminal box. Before starting the compressor ensure that the terminal box is properly closed.

**CAUTION**  
**Mechanical stress or shock! Terminal box damage!** Mechanical stress and shocks to the terminal box must be avoided as they might result in tightness failure or loss of terminal box performance.

**CAUTION**  
**Mechanical stress or shock! Terminal Fusite damage!** Mechanical stress and shocks to the Fusite must be avoided as they could damage the glass and/or ceramic. This might result in hermetic failure or loss of terminal performance. Precautions are required to prevent striking or bending of pins. Bent or damaged pins may result in loss of hermeticity and/or terminal performance.

# Copeland Scroll™



## CAUTION

**Overheating! Terminal Fusite damage!** Ensure correct connection of cables to the compressor terminal Fusite to avoid local overheating of Fusite pins which might lead to refrigerant leaks.

The terminal box is IP65 for all ZB\*KCU compressors.

Special attention shall be paid to the electrical connections owing to possible local overheating.

The maximum thickness of cable connectors for the terminal box shall be 1 mm for all models (see **Figure 8**).

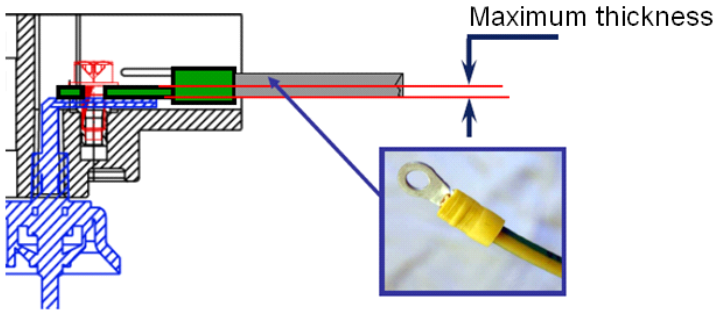

Figure 8

The first two nuts already installed on the Peko bolts shall not be removed, as this will ensure a good tightness of the terminal box assembly. Make sure to assemble the ground connection of the Peko bolt with a torque of 4-4.4 Nm and the ground connection between the cover and the body of the terminal box with a torque of 1.8-2 Nm (see **Figure 9**).

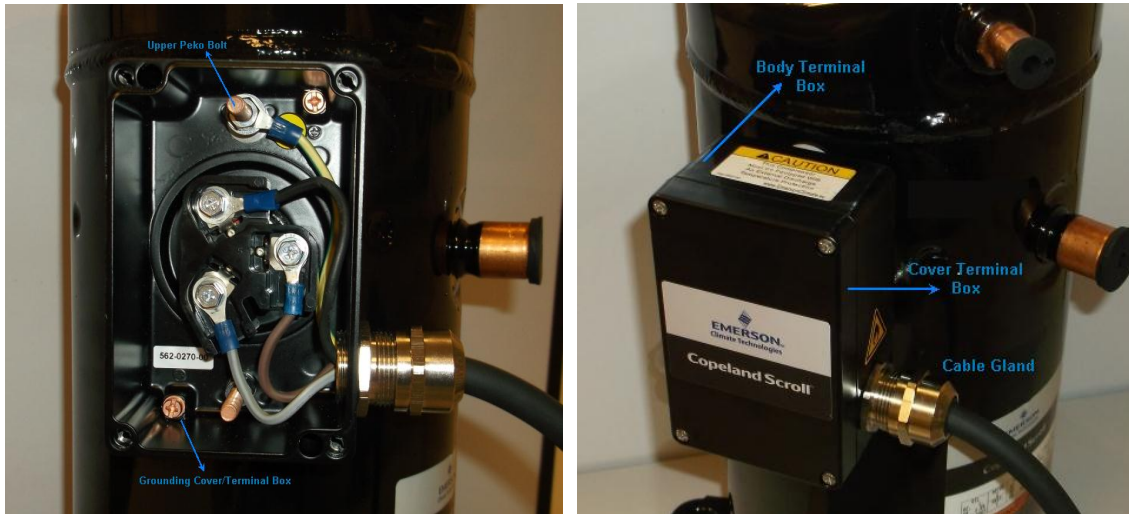
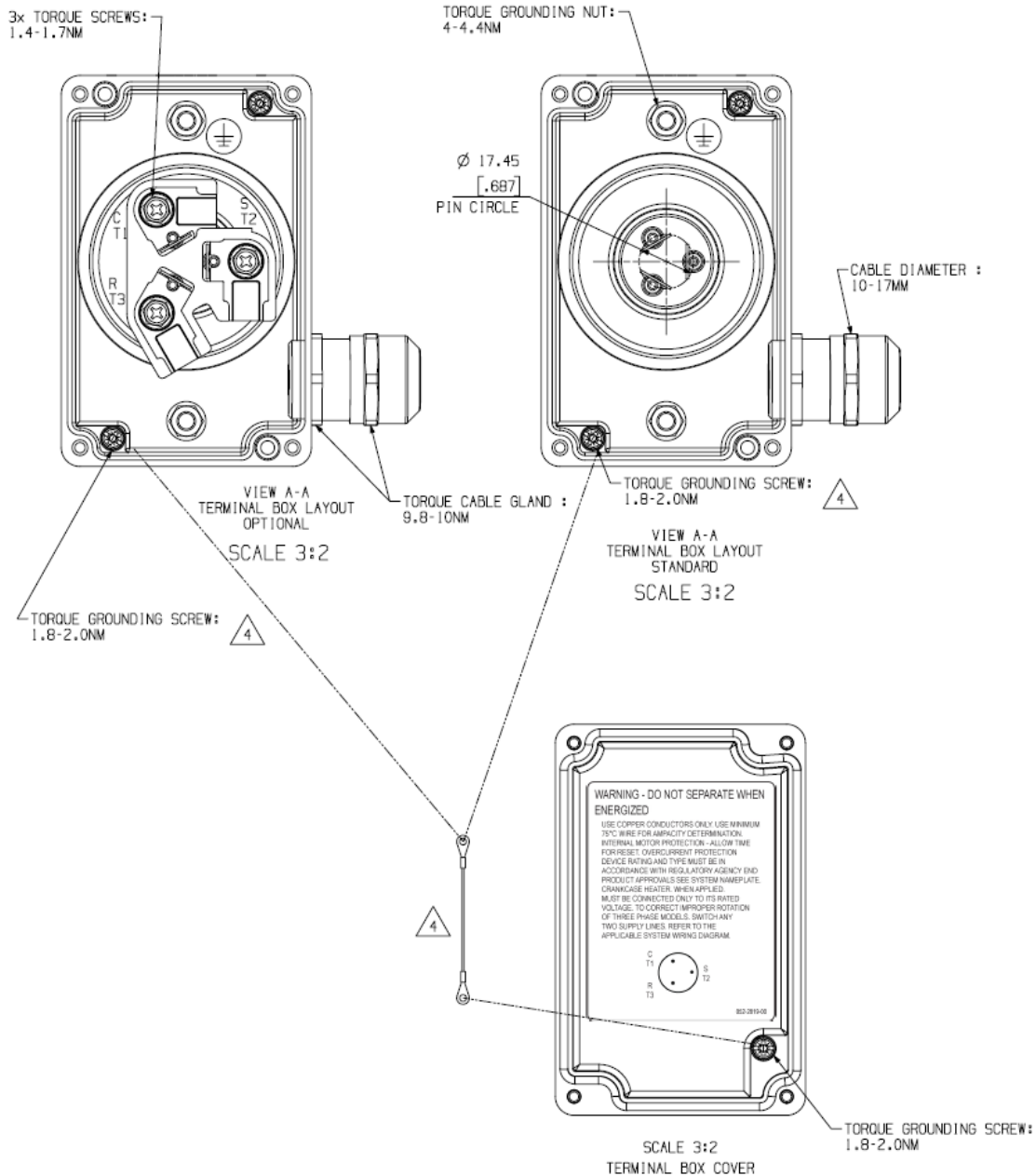

Figure 9: Terminal box and correct electrical installation

Make sure to assemble the cable gland M25 with a torque of 9.8-10 Nm. The cable gland is designed for cable diameters of 10 to 17 mm (see **Figure 10**). The degree of protection (IP) will be safeguarded only if sealing and cable glands are properly assembled. Only run the compressor with permanently wired cables. The system manufacturer/installer shall provide the required strain relief.

Finally, close the cover of the terminal box applying a torque of 1.8-2 Nm. The degree of protection (IP) will be safeguarded only if the cover is properly assembled.



**Figure 10: Cable gland torque and diameter and electrical connections torque**

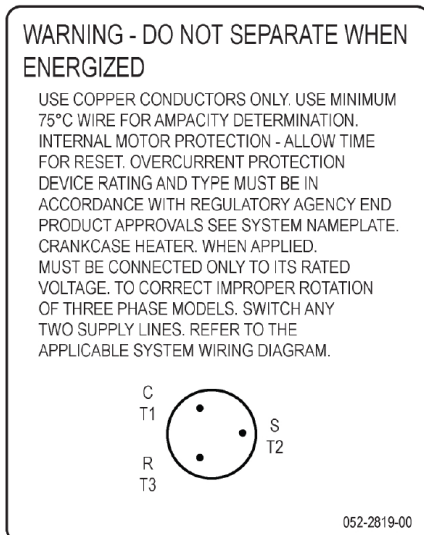

**Figure 11: Wiring diagram label**

# Copeland Scroll™

## 4.2.2 Motor windings

The motor insulation material is class "B" (TF\*) for all ZB\*KCU compressors (maximum allowable operating temperature 130°C (class B), according to IEC 34-1 or DIN 57530).

**NOTE:** For information about electrical motors refer to Technical Information C7.9.1 "Motors for Copeland Scroll™ Compressors" available at [www.emersonclimate.eu](http://www.emersonclimate.eu).

## 4.2.3 Protection devices

Independently from the internal motor protection, fuses must be installed before the compressor. The selection of fuses has to be carried out according to EN 60269-1 or EN 60204-1 and compressor maximum operating current (MOC). Failing to install fuses before the compressor or selecting inappropriate fuses may result in compressor failure.

## 4.2.4 Crankcase heaters



### IMPORTANT

**Oil dilution! Bearing malfunction!** Turn the crankcase heater on 12 hours before starting the compressor. The crankcase heater must remain energised during compressor off cycles.

Crankcase heaters to be used in ATEX Zone 2 locations must comply with the ATEX Directive requirements. Non-ATEX-certified crankcase heaters shall NOT be used in ATEX Zone 2 locations.

The crankcase heater presently available from Emerson Climate Technologies is not ATEX certified and can only be used in non-flammable environments. In case the available crankcase heater has to be ordered, please refer to the Spare Parts list available at [www.emersonclimate.eu](http://www.emersonclimate.eu).

For installation, the user shall follow the recommendations mentioned in the instruction sheet delivered together with the crankcase heater.

## 4.3 Pressure protection devices

Pressure protection devices to be used in ATEX Zone 2 locations must comply with the ATEX Directive requirements. Non ATEX-certified pressure protection devices shall NOT be used in ATEX Zone 2 locations.

ATEX-approved pressure protection devices are available from ALCO Controls. Please refer to our dedicated "Product Guide for R290".

### 4.3.1 High-pressure protection

The high-pressure protection shall be installed according to EN 378.

### 4.3.2 Low-pressure protection



### WARNING

**Operation under ambient pressure! Creation of an explosive mixture! Explosion hazard!** During operation under ambient pressure an explosive mixture can form inside the system. Make sure that the pressure never falls below atmospheric pressure. If it does, immediately de-energize the power supply of the compressor and check the cause of the low pressure before restarting the compressor.



### IMPORTANT

**Operation outside the application envelope! Compressor breakdown!** A low pressure protection shall be fitted in the suction line to stop the compressor when it operates outside the envelope limits.



### IMPORTANT

**Loss of system charge! Loss of lubrication! Bearing malfunction and compressor breakdown!** A low-pressure limiter protection must be installed and set above the atmospheric pressure. Do not bridge or by-pass the low-pressure limiter. Do not operate under atmospheric pressure.

Systems in some instances have to operate at low evaporating pressure because of the low ambient temperatures, sometimes combined with a high level of relative humidity. Proper evaporator sizing and adequate defrost strategy control will prevent the system from operating outside the operating envelope published by Emerson Climate Technologies, whatever the climatic conditions and the capacity demand.

However, in some extreme cases – such as loss of system charge, extreme heat transfer restriction at the evaporator, any defect or blocked flow control component (expansion valve, screens, etc.) – the evaporating conditions may be such that the compressor will operate outside the published operating envelope limits. These conditions may result in compressor failure.

Therefore, Emerson Climate Technologies requires that all ZB\*KCU compressors without exception be fitted with a low pressure protection in the suction line, ie, no service valve between compressor and pressure limiter is allowed. The mandatory inclusion of a low pressure switch will stop the compressor operating outside the published envelope limits or below atmospheric pressure.

### 4.3.3 Internal pressure relief valve

There is an internal pressure relief valve on all ZB\*KCU refrigeration scroll compressors. It opens at a differential pressure of 28 bar ± 3 bar between high- and low-pressure sides. A high pressure protection must be provided by the system manufacturer/installer for each system and according to EN 378-2, clause 6.2.6.2. The IPR valve is a safety device, not an HP switch. It is not designed for repeated operation and there is no guarantee that it will reset correctly if it does have repeated operation.

## 4.4 Discharge gas temperature protection



### IMPORTANT

**Inadequate lubrication! Scroll set damage!** All ZB\*KCU compressors must be equipped with an external discharge gas temperature protection.

A good system control shall prevent the system from operating outside the published operating envelope and acceptable superheat range, whatever the climatic conditions and the capacity demand. However, under some extreme operating conditions (such as loss of charge or improper control operation), the internal discharge gas temperature reached can cause compressor damage. In order to guarantee positive compressor protection, discharge gas temperature protection is required for any application with Copeland brand compressors. This protection must not be used as an operating envelope controller but as a safety device.

The maximum discharge gas temperature is 135°C for models ZB12KCU to ZB20KCU and 130°C for models ZB25KCU to ZB49KCU. These compressors have no internal discharge gas temperature protection. Therefore, an external discharge gas temperature protector must be installed. The discharge temperature protection device shall comply with the requirements of the ATEX Directive 94/9/EC for Zone 2.

### 4.4.1 Excessive discharge gas temperatures

A few of the possible consequences are listed below:

- Since the oil circulates in the system with the refrigerant, it is subjected to high discharge gas temperatures. If the discharge gas temperature becomes too high, the so-called "cooking" effect will occur (heating of oil under exclusion of air). Carbon deposits can form at points of high temperature, for example on the valves, oil channels, oil filters, etc. The oil lubricity will be reduced and a progressive wear process will occur which will prematurely damage the compressor.
- The stability of the refrigerant can also be affected, particularly if traces of contaminant are present.
- The problems listed under the first 2 points frequently occur simultaneously, particularly since the chemical reaction time approximately doubles at every 10°C temperature rise. This directly leads to chemical reactions of the oil with the refrigerant and the compounds extracted from sealants and insulation material. As a consequence contaminants of various types, among them acids, will form inside the system.

# Copeland Scroll™

## 4.4.2 Discharge gas temperature protection

Discharge gas temperature protection is the “fall-back” for failure of the system control. It is essential that proper control of evaporating and condensing pressures and superheat is maintained and has the ability to cope with all likely conditions and high loads. Reliance on protectors will cause inadequate system performance and short cycling.

The external discharge thermostat presently available from Emerson Climate Technologies is not ATEX certified and can only be used in non-flammable environments. In case the available thermostat has to be ordered, please refer to the Spare Parts list available at [www.emersonclimate.eu](http://www.emersonclimate.eu).

## 4.4.3 Assembly of external discharge gas temperature protection

The sensor must be mounted on the discharge pipe 120 mm from the compressor shell. To avoid any impact of the ambient on the tripping temperature the sensor must be insulated.

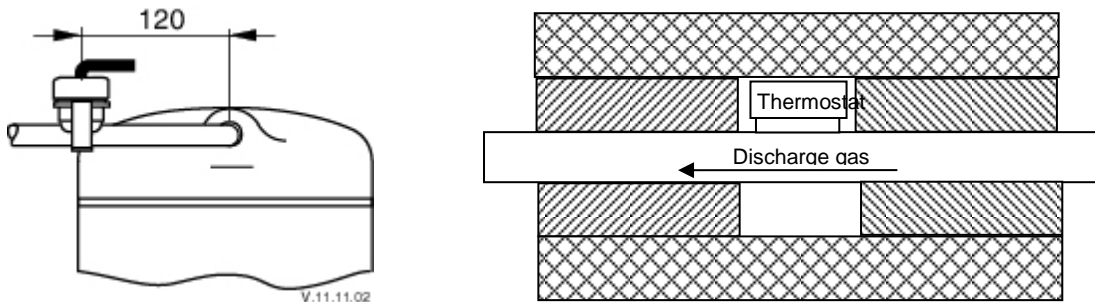

Figure 12: Example of installation of an external discharge gas temperature protection

Thorough system tests will ensure positive compressor protection and will avoid nuisance tripping inside the envelope.

## 4.5 Motor protection

Conventional inherent internal line break motor protection is provided for the ZB\*KCU range of compressors.

## 4.6 High-potential testing



### WARNING

**Conductor cables! Electrical shock!** Shut off power supply before high-potential testing.



### CAUTION

**Internal arcing! Motor destruction!** Do not carry out high-voltage or insulation tests if the compressor housing is under vacuum.

Emerson Climate Technologies subjects all Scroll compressors to a high-voltage test after final assembly. Each motor phase winding is tested according to EN 60034-1 at a differential voltage of 1000V plus twice the nominal voltage. Since high-voltage tests lead to premature ageing of the winding insulation further additional tests of that nature are not recommended.

If it has to be done for any reason, a lower voltage must be used. Disconnect all electronic devices, eg, motor protection module, fan speed control, etc prior to testing.

## 5 Starting up & operation



### WARNING

**Diesel effect! System explosion!** The mixture of air and oil at high temperature can lead to an explosion. Avoid operating with air.



### WARNING

**Air/R290 mixture! Explosive atmosphere!** Check the concentration of refrigerant in the atmosphere before starting the compressor. If the concentration level exceeds the lower flammable limit (LFL) as regulated by EN 378-1 Annex E, no compressor starting is allowed. Ensure that the system contains only refrigerant.



### IMPORTANT

**Oil dilution! Bearing malfunction!** It is important to ensure that new compressors are not subjected to liquid abuse. It is mandatory to have a crankcase heater installed if the refrigerant charge is above 1.54 kg for compressors ZB12KCU to ZB20KCU, and 1.93 kg for compressors ZB25KCU to ZB49KCU. Turn the crankcase heater on 12 hours before starting the compressor.

### 5.1 Strength-pressure test



### WARNING

**High pressure! Personal injuries!** Consider personal safety requirements and refer to test pressures prior to test.



### WARNING

**System explosion! Personal injuries!** Use only dry nitrogen for pressure testing. DO NOT USE other industrial gases.



### CAUTION

**System contamination! Bearing malfunction!** Use only dry nitrogen for pressure testing. DO NOT USE other industrial gases.

The compressor has been strength-pressure tested in the Emerson Climate Technologies factory according to EN 14276-1 and EN 60335-2-34 standards. Therefore it is not necessary for the manufacturer/installer to strength-pressure test the compressor on the assembly/system.

Since it is not possible to isolate the compressor from the rest of the system, system strength-pressure testing according to EN 378-2 should be carried out in two steps at two different test pressures, the high-side test pressure HPT and the low-side test pressure LPT:

- First, apply for a short time the HPT in the high pressure section of the system up to the compressor discharge stub. The compressor check valve automatically closes to isolate the low pressure side. During that test, make sure that the low pressure side of the system does not exceed the compressor maximum standstill pressure, ie, the compressor low side PS.
- Then, test the low pressure section of the system respecting the low side PS and according to relevant standards.

**NOTE:** For more information please refer to Technical Information CC7.4.1 “Pressure equipment directive applied to Copeland brand products” available at [www.emersonclimate.eu](http://www.emersonclimate.eu).

### 5.2 Compressor tightness test



### WARNING

**High pressure! Personal injuries!** Consider personal safety requirements and refer to test pressures prior to test.



### WARNING

**System explosion! Personal injuries!** Use only dry nitrogen for leak testing. DO NOT USE other industrial gases.





## CAUTION

**System contamination! Bearing malfunction!** Use only dry nitrogen for leak testing. DO NOT USE other industrial gases.

The compressor has been leak-pressure tested in the Emerson Climate Technologies factory. Therefore it is not necessary for the system manufacturer/installer to leak-pressure test the compressor on the assembly/system.

Never add refrigerant to the test gas (as leak indicator).

### 5.3 System evacuation

Before the installation is put into commission, it has to be evacuated with a vacuum pump. The vacuum pump and all tools have to be approved for R290/air mixture. The installation should be evacuated down to 0.3 mbar / 0.22 Torr. Proper evacuation reduces residual moisture to 50 ppm. During the initial procedure, suction and discharge shut-off valves on the compressor remain closed. The installation of adequately sized access valves at the furthest point from the compressor in the suction and liquid lines is advisable. Pressure must be measured using a vacuum pressure (Torr) gauge on the access valves and not on the vacuum pump; this serves to avoid incorrect measurements resulting from the pressure gradient along the connecting lines to the pump.

Evacuating the system only on the suction side of a Scroll compressor can occasionally result in a temporary no-start condition for the compressor. The reason for this is that the floating seal could axially seal with the scroll set, with the higher pressure on the floating seal. Consequently, until the pressures equalise, the floating seal and scroll set can be held tightly together.

The highest demands are placed on the leak-proof design of the installation and on the leak testing methods (please refer to EN 378).

### 5.4 Preliminary checks – Pre-starting

Discuss details of the installation with the installer. If possible, obtain drawings, wiring diagrams, etc. It is ideal to use a check-list but always check the following:

- No explosive atmosphere or flammable gas in the ambient
- Suitable ventilation according to the room volume and to the refrigerant charge
- Visual check of the electrics, wiring, fuses etc
- Cable glands in good state, all electrical connections well connected and terminal box closed to ensure corresponding IP protection
- Visual check of the plant for leaks, loose component parts such as TXV bulbs or solenoid valve coil, loose wires in electrical installation, etc
- Functional test of HP & LP switches and any pressure actuated valves
- Check setting and operation of all safety features and protection devices
- All valves in the correct running position
- Pressure and compound gauges fitted
- Correctly charged with refrigerant
- Compressor electrical auxiliary switch location and position

### 5.5 Charging procedure



## WARNING

**Air/R290 mixture in a potentially explosive atmosphere! Explosion hazard!** In any case avoid air/R290 mixture in the refrigeration system. Make sure that the system is filled with pure R290.



## CAUTION

**Low suction pressure operation! Compressor damage!** Do not operate with a restricted suction. Do not operate with the low-pressure limiter bridged. Do not operate compressor at pressures that are not allowed by the operating envelope. Allowing the suction pressure to drop below the envelope limit for more than a few seconds may overheat scrolls and cause early drive bearing and moving parts damage.

The system shall be liquid-charged through the liquid-receiver shut-off valve or through a valve in the liquid line. The use of a filter drier in the charging line is highly recommended. Since scrolls have discharge check valves, systems shall be liquid-charged on both the high and low sides simultaneously to ensure a positive refrigerant pressure is present in the compressor before it runs. The majority of the charge shall be placed in the high side of the system to prevent bearing washout during first-time start on the assembly line.

The manufacturer and installer must respect the charge limitations according to EN 378-2 and EN 60335-2-40 standards.

## 5.6 Run-in time

Scroll compressors exhibit a slight decrease in input power during the initial running period. Published performance ratings are based on calorimeter testing which is carried out after run-in. Therefore users should be aware that before the performance specified by EN 12900 is achieved the compressor needs to be run in. Recommended run-in times for ZB\*KCU compressors to attain the published performance are 16 hours at the saturation evaporating and condensing temperature conditions -10/45°C with a superheat of 10K.

## 5.7 Initial start-up



### CAUTION

**Oil dilution! Bearing malfunction!** It is important to ensure that new compressors are not subjected to liquid abuse. It is mandatory to have a crankcase heater installed if the refrigerant charge is above 1.54 kg for compressors ZB12KCU to ZB20KCU, and 1.93 kg for compressors ZB25KCU to ZB49KCU. Turn the crankcase heater on 12 hours before starting the compressor.



### CAUTION

**High discharge pressure operation! Compressor damage!** Do not use compressor to test opening set point of high-pressure limit. Bearings and moving parts are susceptible to damage before they have had several hours of normal running in.

Liquid and high pressure loads could be detrimental to new bearings. It is therefore important to ensure that new compressors are not subjected to liquid abuse and high-pressure run tests. It is not good practice to use the compressor to test the high-pressure switch function on the production line. Switch function can be tested with nitrogen prior to installation and wiring can be checked by disconnecting the high-pressure switch during the run test.

## 5.8 Rotation direction

Scroll compressors, like several other types of compressors, will only compress in one rotational direction. Three-phase compressors will rotate in either direction depending upon phasing of the power. Since there is a 50-50 chance of connecting power in such a way as to cause rotation in the reverse direction, **it is important to include notices and instructions in appropriate locations on the equipment to ensure proper rotation direction when the system is installed and operated.**

Observing that suction pressure drops and discharge pressure rises when the compressor is energized allows verification of proper rotation direction. There is no negative impact on durability caused by operating three-phase Scroll compressors in the reversed direction for a short period of time (under one hour) but oil may be lost. Oil loss can be prevented during reverse rotation if the tubing is routed at least 15 cm above the compressor. After several minutes of operation in reverse, the compressor protection system will trip due to high motor temperature. The operator will notice a lack of cooling or heating. However, if allowed to repeatedly restart and run in reverse without correcting the situation, the compressor will be permanently damaged.

All three-phase scroll compressors are identically wired internally. Therefore, once the correct phasing is determined for a specific system or installation, connecting properly phased power leads to the identified compressor terminals will ensure proper rotation direction.

# Copeland Scroll™

## 5.9 Starting sound

During the very brief start-up, a clicking sound is audible, resulting from initial contacting of the spirals and is normal. Due to the design of the Copeland Scroll compressors, the internal compression components always start unloaded even if system pressures are not balanced. In addition, since internal compressor pressures are always balanced at start-up, low-voltage starting characteristics are excellent for Copeland Scroll compressors.

## 5.10 Deep vacuum operation



### CAUTION

**Vacuum operation! Compressor damage!** Copeland Scroll compressors should never be used to evacuate refrigeration or air-conditioning systems.

The scroll compressor can be used to pump down refrigerant in a unit as long as the pressures remain within the operating envelope. Low suction pressures will result in overheating of the scrolls and permanent damage to the compressor drive bearing and moving parts.

## 5.11 Shell temperature

The top shell and discharge line can briefly but repeatedly reach temperatures above 177°C if the compressor cycles on its internal protection devices. This only happens under rare circumstances and can be caused by the failure of system components such as the condenser or evaporator fan or loss of charge and depends upon the type of expansion control. Care must be taken to ensure that wiring or other materials that could be damaged by these temperatures do not come in contact with the shell.

## 5.12 Pump down cycle



### WARNING

**Vacuum operation! Creation of an explosive mixture! Explosion hazard!**

During operation in vacuum an explosive mixture can form inside the system. Pumping down outside the operating envelope or below atmospheric pressure is not allowed. If this happens, immediately stop the compressor and/or de-energize the power supply of the compressor.



### CAUTION

**Vacuum operation! Compressor damage!** Compressor operation outside the operating envelope is not allowed.

A pump down cycle to control refrigerant migration may have to be used when the compressor is located outside without any housing so that cold air blowing over the compressor makes the crankcase heater ineffective.

**If a pump down cycle is used, a separate external check valve must be added.** The scroll discharge check valve is designed to stop extended reverse rotation and prevent high-pressure gas from leaking rapidly into the low side after shut-off. The check valve will in some cases leak more than reciprocating compressor discharge reeds, normally used with pump down, causing the scroll compressor to recycle more frequently. Repeated short-cycling of this nature can result in a low oil situation and consequent damage to the compressor. The hysteresis of the low-pressure control differential has to be reviewed since a relatively large volume of gas will re-expand from the high side of the compressor into the low side after shutdown.

**For pressure control setting, never set the low-pressure limiter to shut off outside of the operating envelope. To prevent the compressor from running into problems during such faults as loss of charge or partial blockage, the low pressure limiter shall not be set lower than the minimum suction pressure allowed by the operating envelope.**

## 5.13 Minimum run time

Emerson Climate Technologies recommends a maximum of 10 starts per hour. There is no minimum off time because scroll compressors start unloaded, even if the system has unbalanced pressures. The most critical consideration is the minimum run time required to return oil to the compressor after start-up. To establish the minimum run time, a sample compressor equipped with a level glass - for lab testing only and with a liability letter - can be ordered from

Emerson Climate Technologies. The minimum on time becomes the time required for oil lost during compressor start-up to return to the compressor sump and restore a minimal oil level that will ensure oil pick-up through the crankshaft. Cycling the compressor for a shorter period than this, for instance to maintain very tight temperature control, will result in progressive loss of oil and damage to the compressor.

## 5.14 Shut-off sound

Scroll compressors incorporate a device that minimizes reverse rotation. The residual momentary reversal of the scrolls at shut off will cause a clicking sound, but it is entirely normal and has no effect on compressor durability.

## 5.15 Supply frequency and voltage

There is no general release of standard Copeland Scroll compressors for use with variable speed AC drives. There are numerous issues that must be considered when applying Scroll compressors with variable speed, including system design, inverter selection, and operating envelopes at various conditions.

The last digit of the model motor code indicates which frequency and voltage must be applied - see Chapter 2.2 "Nomenclature". Availability of codes per compressor model can be checked in Chapter 2.1 "Common information about Copeland Scroll™ compressors".

50 Hz	Code
380-420 / 3 ph	M

Table 4: Typical electrical codes for ZB models

## 5.16 Oil level

ZB\*KCU compressors are without a sight glass to ensure maximum hermetic design.

During the system development phase, adequate oil return in any operation should be checked whatever the compressor model. For this purpose, a sample compressor equipped with a level glass - for lab testing only and with a liability letter - can be ordered from Emerson Climate Technologies. A sample compressor is shown in **Figure 13** below. The dimensions of the level glass are shown in **Table 5**.



# Copeland Scroll™

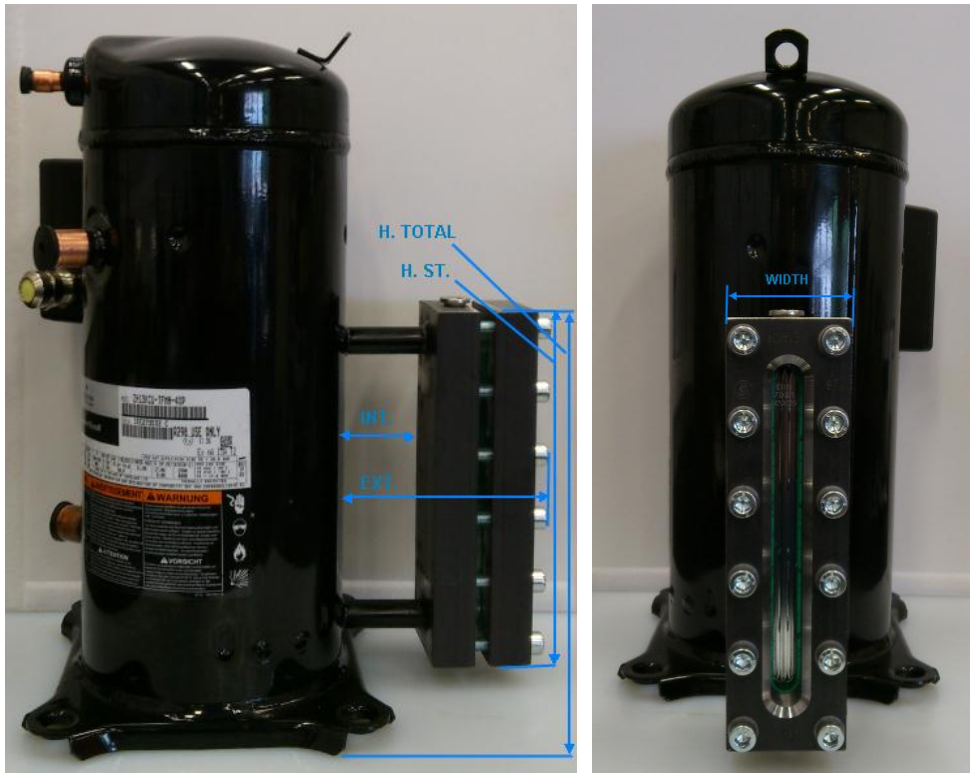

Figure 13: Sample compressor equipped with a level glass

Interior	Exterior	Height level glass	Total height	Width
± 65 mm	± 145 mm	± 250 mm	± 270 mm	± 70 mm

Table 5: Dimensions of level glass

The sample compressors can be used for oil return check in single or tandem applications. Oil return check test recommendations for paralleling are available in Application Bulletin C32.17.2 “Tandem/Trio Oil Return and Balancing Verification / Floodback Tests” and in Technical Information C7.17.4 “Paralleling of ZH\*KCU and ZB\*KCU”, available on request from Application Engineering.

## 6 Maintenance & repair



### WARNING

**Conductor cables! Electrical shock!** Follow the lockout/tag out procedure and the national regulations before carrying out any maintenance or service work on the system.



### WARNING

**Air/R290 mixture in a potentially explosive atmosphere! Explosion hazard!** Immediately stop the compressor and/or de-energize the power supply of the compressor and any other electrical component/equipment, eg, crankcase heater in case of explosive atmosphere. When opening the refrigeration system or working on it avoid explosive atmosphere and ignition sources in any case. When replacing the compressor avoid explosive mixture (air/R290).

To maximize efficiency in controlling leaks when opening the refrigeration system or working on it, it is recommended to use a leak detector designed for use with R290 refrigerant.



### WARNING

**Air/R290 mixture in a potentially explosive atmosphere! Fire hazard!** Continuously check if the ambient atmosphere is non explosive.

In case of explosive atmosphere:

- do not energize any electrical component in the system;
- fire and smoking are strictly forbidden;
- no unshielded flame is allowed;
- power tools shall not be used.

Furthermore, before opening the refrigeration system or working on it with an unshielded flame:

- continuously check if the ambient atmosphere is non explosive and ensure proper ventilation of the room;
- if the atmosphere reaches a dangerous concentration of flammable gas, avoid any ignition source and ventilate the room further;
- if parts of the refrigeration system are charged with flammable refrigerant, be sure that all the valves are tightly closed and that the open pipes after the valves are free of refrigerant and oil.

### 6.1 Disassembling system components



### WARNING

**Air/R290 mixture in a potentially explosive atmosphere! Fire hazard!** Fire and smoking are strictly forbidden at all times. Continuously check if the ambient atmosphere is non explosive.

During service make sure that:

- the area is well ventilated;
- the materials and equipment used are suitable for use under explosive conditions;
- only non-sparking tools are used;
- antistatic gloves and clothes are used;
- build-up of electrostatic charges is avoided.

In case of explosive atmosphere:

- do not energize any electrical component in the system;
- no unshielded flame is allowed.



### WARNING

**Unshielded flame! Fire hazard!** Oil-refrigerant mixtures are highly flammable. Remove all refrigerant before opening the system. Avoid working with an unshielded flame in a refrigerant charged system. Use a pipe cutting tool to disassemble the compressor from the system.

# Copeland Scroll™

When disassembling system components please follow the main steps described hereunder:

1. Recover refrigerant and evacuate system using a hydrocarbons-dedicated recovery unit and vacuum pump.
2. Flush system with dry nitrogen.
3. Disassemble components with a cutting tool.
4. Drain, recover and dispose of compressor oil as appropriate.

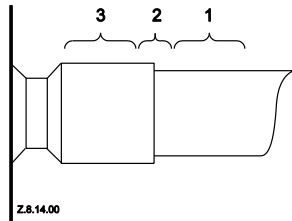

Figure 14: Tube connecting areas

## To disconnect:

- Using a pipe cutting tool, cut off the suction and discharge lines in such a manner that the new compressor can easily be re-connected into the system.
- Heat joint areas 2 and 3 slowly and uniformly until the braze material softens and the tube end can be pulled out from the fitting.

## To reconnect:

- Recommended brazing material: Silfos with minimum 5% silver or silver braze used on other compressors.
- Due to the different thermal properties of steel and copper, brazing procedures may have to be changed from those commonly used.

**NOTE:** Since the discharge stub contains a check valve, care must be taken not to overheat it to prevent brazing material from flowing into it.

## 6.2 Exchanging the refrigerant



### WARNING

**Air/R290 mixture! Explosive atmosphere!** In any case avoid air/R290 mixture in the refrigeration system. Make sure that the system is filled with pure R290. In the event that the refrigerant needs replacing, the charge should be recovered using a R290 recovery unit and dedicated cylinders.



### CAUTION

**Low suction pressure operation! Compressor damage!** Do not operate with a restricted suction. Do not operate with the low-pressure limiter bridged. Do not operate compressor at pressures that are not allowed by the operating envelope. Allowing the suction pressure to drop below the envelope limit for more than a few seconds may overheat scrolls and cause early drive bearing and moving parts damage.

Qualified refrigerants and oils are given in Chapter 2.3.1.

It is not necessary to replace the refrigerant with new unless contamination due to an error such as topping up the system with an incorrect refrigerant is suspected. To verify correct refrigerant composition, a sample can be taken for chemical analysis. A check can be made during shut down by comparing the refrigerant temperature and pressure using precision measurements at a location in the system where liquid and vapour phases are present and when the temperatures have stabilised. In the event that the refrigerant needs replacing, the charge should be recovered using a suitable recovery unit.

## 6.3 Replacing a compressor



### WARNING

**Air/R290 mixture! Explosive atmosphere!** When opening the refrigeration system or working on it avoid explosive atmosphere and ignition sources in any case. When replacing the compressor avoid explosive mixture (air/R290). Use a pipe cutting tool to disassemble the compressor from the system.



## WARNING

### Air/R290 mixture in a potentially explosive atmosphere! Fire hazard!

Fire and smoking are strictly forbidden at all times.

In case of explosive atmosphere:

- do not energize any electrical component in the system;
- no unshielded flame is allowed.

Furthermore, before opening the refrigeration system or working on it:

- continuously check if the ambient atmosphere is non explosive and ensure proper ventilation of the room;
- if the atmosphere is explosive or reaches a dangerous concentration of flammable gas, avoid any ignition source and ventilate the room further;
- if parts of the refrigeration system are charged with flammable refrigerant, be sure that all the valves are tightly closed and that the open pipes after the valves are free of refrigerant and oil.



## CAUTION

**Inadequate lubrication! Bearing destruction!** Exchange the accumulator after replacing a compressor with a burned out motor. The accumulator oil return orifice or screen may be plugged with debris or may become plugged. This will result in starvation of oil to the new compressor and a second failure.

### 6.3.1 Compressor replacement



## WARNING

### Air/R290 mixture in a potentially explosive atmosphere! Fire hazard!

Use a suitable cylinder for oil disposal as R290 may still be solved in the oil.

In the case of an R290 compressor replacement the oil has to be drained out of the compressor and the compressor should be flushed with dry nitrogen. DO NOT close the stubs with plugs.

In the case of a motor burnout, the majority of contaminated oil will be removed with the compressor. The rest of the oil is cleaned through the use of suction and liquid line filter driers. A 100% activated alumina suction line filter drier is recommended but must be removed after 72 hours.

**It is highly recommended that the suction accumulator be replaced if the system contains one.** This is because the accumulator oil return orifice or screen may be plugged with debris or may become plugged shortly after a compressor failure. This will result in starvation of oil to the replacement compressor and a second failure. When a single compressor or tandem is exchanged in the field, it is possible that a major portion of the oil may still be in the system. While this may not affect the reliability of the replacement compressor, the extra oil will add to rotor drag and increase power usage.

### 6.3.2 Start-up of a new or replacement compressor

Rapid charging only on the suction side of a scroll-equipped system can occasionally result in a temporary no-start condition for the compressor. The reason for this is that, if the flanks of the compressor happen to be in a sealed position, rapid pressurisation of the low side without opposing high-side pressure can cause the scrolls to seal axially. As a result, until the pressures eventually equalise, the scrolls can be held tightly together preventing rotation. The best way to avoid this situation is to charge on both the high and low sides simultaneously at a rate which does not result in axial loading of the scrolls.



A minimum suction pressure specified in the published operating envelope must be maintained during charging. Allowing the suction pressure to drop below that value may overheat the scrolls and cause early drive bearing and moving parts damage. Never install a system in the field and leave it unattended when it has no charge, a holding charge, or with the service valves closed without securely electrically locking out the system. This will prevent unauthorised personnel from accidentally operating the system and potentially ruining the compressor by operating with no refrigerant flow. **Do not start the compressor while the system is in a deep vacuum.** Internal arcing may occur when a Scroll compressor is started in a vacuum causing burnout of the internal lead connections.



## 6.3.3 Compressor return procedure

If a compressor has to be returned to the manufacturer for analysis the procedure below shall be followed:

- During the entire working procedure continuously check if the ambient atmosphere is explosive. If explosive atmosphere is detected ensure proper ventilation of the working space and immediately cut-off the power supply.
- Resume working after the atmosphere is no longer dangerous.
- Recover the refrigerant from the system using a suitable recovery unit. During this action the compressor crankcase heater should be energized - immediately de-energize in case an explosive atmosphere is detected.
- Do not allow the recovery unit to recover below atmospheric pressure. Make sure the low pressure switch that stops the recovery process is not set below 0.5 bar(g).
- At this pressure some refrigerant will still be in the system. Therefore, before opening the system, pressurize to 1 bar(g) with dry nitrogen.
- Open the system with a cutting tool and flush the entire system with dry nitrogen.
- Disassemble the compressor with a cutting tool. Drain and recover compressor oil properly. Flush the compressor with dry nitrogen for a few minutes.
- The compressor should be returned free of oil and with connections open - do not close connections with plugs.
- Properly collect and secure the oil. Provide information about the quantity of oil drained from the compressor and its colour. Ideally, send a good picture.
- Dispose of the oil according to local rules and regulations.
- Use a proper cardboard box package when preparing the compressor for shipment. Place

warning icons  and  on each side and on the top of the box. Mention the following message on the box: **“Warning! Hydrocarbon compressor for analysis”**.

- The compressor shipment has to be kept in the upright position – mark it accordingly.
- If more than one compressor has to be returned, each compressor has to be packed individually.

**NOTE:** Check with your transport company that all the requirements that apply to such shipment are complied with.

## 6.4 Lubrication and oil removal



### WARNING

**Air/R290 mixture in a potentially explosive atmosphere! Fire hazard!**  
Use a suitable cylinder for oil disposal as R290 may still be solved in the oil.



### CAUTION

**Chemical reaction! Compressor destruction!** Do not mix up ester oils with mineral oil and/or alkyl benzene.

The compressor is supplied with an initial oil charge. The standard oil charge for use with refrigerant R290 is a polyolester (POE) lubricant. See nameplate for original oil charge shown in litres. A field recharge is from 0.05 to 0.1litre less.

One disadvantage of POE is that it is far more hygroscopic than mineral oil (see **Figure 15**). Only brief exposure to ambient air is needed for POE to absorb sufficient moisture to make it unacceptable for use in a refrigeration system. Since POE holds moisture more readily than mineral oil it is more difficult to remove it through the use of vacuum. Compressors supplied by Emerson Climate Technologies contain oil with low moisture content, and it may rise during the system assembling process. Therefore it is recommended that a properly sized filter-drier is installed in all POE systems. This will maintain the moisture level in the oil to less than 50 ppm. If oil is charged into a system, it is recommended to use POE with moisture content no higher than 50 ppm.

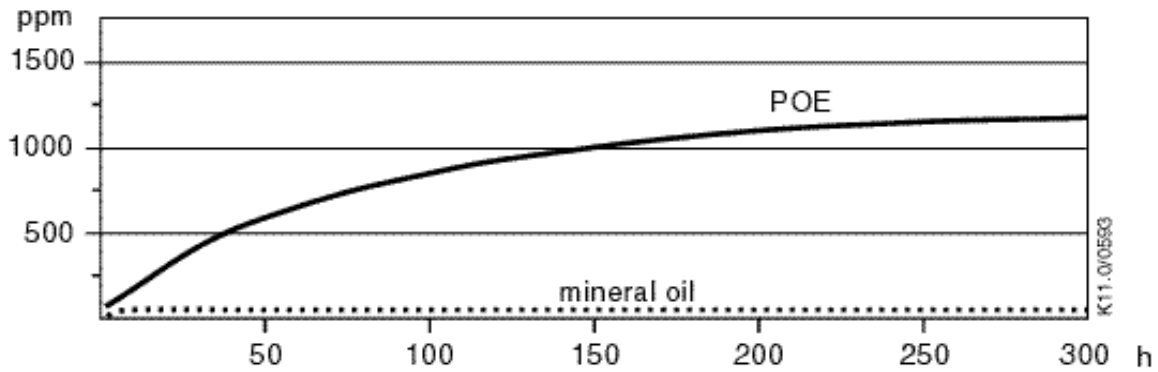

Figure 15: Absorption of moisture in ester oil in comparison to mineral oil in ppm by weight at 25° C and 50% relative humidity (h=hours)

If the moisture content of the oil in a refrigeration system reaches unacceptably high levels, corrosion and copper plating may occur. The system should be evacuated down to 0.3 mbar or lower. If there is uncertainty as to the moisture content in the system, an oil sample should be taken and tested for moisture. Sight glass/moisture indicators currently available can be used with the R290 refrigerant and lubricants; however, the moisture indicator will just show the moisture contents of the refrigerant. The actual moisture level of POE would be higher than the sight glass indicates. This is due to the high hygroscopicity of the POE oil. To determine the actual moisture content of the lubricant, samples have to be taken from the system and analysed.

## 6.5 Oil additives

Although Emerson Climate Technologies cannot comment on any specific product, from our own testing and past experience, we do not recommend the use of any additives to reduce compressor bearing losses or for any other purpose. Furthermore, the long term chemical stability of any additive in the presence of refrigerant, low and high temperatures, and materials commonly found in refrigeration systems is complex and difficult to evaluate without rigorously controlled chemical laboratory testing. The use of additives without adequate testing may result in malfunction or premature failure of components in the system and, in specific cases, in voiding the warranty on the component.

## 7 Troubleshooting

Most in-warranty electrical failures are a result of mechanical problems (particles in the oil, liquid refrigerant in the oil, etc.) and most mechanical problems are a result of system problems. Unless the reason for the failure is found, replacing the compressor will probably lead to another compressor failure.

If the compressor fails to start and run properly, it is important that the compressor be tested to determine its condition. It is possible that electrical components may be defective, the protector may be open, or a safety device may have tripped. Here is a list of the most common compressor problems encountered in the field.



### WARNING

**Electrical cables! Electrical shock!** Before attempting any electrical troubleshooting, make sure all grounds are connected and secure and there is ground continuity throughout the compressor system. Also ensure the compressor system is correctly grounded to the power supply. If you are not a qualified service person familiar with electrical troubleshooting techniques, DO NOT PROCEED until a qualified service person is available.



### WARNING

**Diesel effect! System explosion!** The mixture of air and oil at high temperature can lead to an explosion. Avoid operating with air.



### WARNING

**Air/R290 mixture! Explosive atmosphere!** Check the concentration of refrigerant in the atmosphere before starting the compressor and ensure proper ventilation of the room. If the level is explosive no compressor starting is allowed. In any case be sure that the system contains only refrigerant and no explosive mixture.

Condition	Cause	Corrective action
The Scroll compressor does not run, instead a buzz sound can be heard	Wired incorrectly	Check the power supply on the compressor terminals if there is voltage measured. Trace the wiring diagram to see where the circuit is interrupted.
	Low supply voltage	If the voltage falls below 90% of the nameplate voltage, the motor may develop insufficient torque. Make sure the compressor is supplied with rated nominal voltage.
	Shorted or grounded motor windings	Check the motor for ground by means of a continuity check between the terminals. If grounded replace compressor.
	Internal compressor mechanical damage	<ul style="list-style-type: none"> <li>Refrigeration migration: When the compressor is switched off for a long period refrigerant can condense in the crankcase. If the compressor body is colder than the evaporator, refrigerant will move from the evaporator to the compressor crankcase. Refrigerant migration normally occurs when the compressor is installed in a cold area. A crankcase heater and/or a pump down cycle provide good protection against refrigerant migration.</li> <li>Acid formation: Acid forms in the presence of moisture, oxygen, metal, salts, metal oxides and/or high discharge temperatures. The chemical reactions are accelerated at higher temperatures. Oil and acid react with each other. Acid formation leads to damage of the moving parts and in extreme cases to motor burnout. Several different test methods can be used to test for acid formation. If acid is present a complete oil change (including the oil in the oil separator) will help. A suction filter which removes acid should also be fitted. Check filter-drier condition.</li> </ul>

# Copeland Scroll™

Condition	Cause	Corrective action
The Scroll compressor does not run, no buzz sound can be heard	Compressor motor protector open	Check if there is continuity on the compressor external protector. If the compressor is warm, it may require considerable time to cool down.
	Defective system control components	Check if the pressure control or thermostat works properly or if the controls are open.
	Power circuit open	Check the fuse for a tripped circuit breaker or for an open disconnected switch.
	Burned motor winding	<ul style="list-style-type: none"> <li>▪ If motor burned is due to undersized contactors, this is observed when the contacts welded together. Complete motor burnout on all three phases despite the presence of a functioning protection system can be the result. For sizing information please consult with Contactor manufacturer data sheet. If the application of the compressor is changed the contactor sizing should be rechecked.</li> <li>▪ Check for unbalanced voltage.</li> </ul>
The Scroll compressor trips on motor protection	High discharge pressure / suction pressure	<ul style="list-style-type: none"> <li>▪ For high discharge pressure:                             <ul style="list-style-type: none"> <li>- Check for system leaks. With system leaks at the low pressure side, air as non-condensable gas could enter the system and create high pressure.</li> <li>- Check the system design. Make sure the discharge line is correctly sized: undersized discharge line can increase discharge pressure. This is also true for an undersized condenser. Correct the component selection as needed.</li> <li>- Check the fan motor, make sure it is running properly in the right direction. Check the condenser: if dirt has been accumulated it will clog the airflow; clean as necessary. High discharge pressure is also caused by an overcharged system and high ambient temperature surrounding the condenser.</li> </ul> </li> <li>▪ For high suction pressure, check the “evaporator superheat” first to diagnose the problem:                             <ul style="list-style-type: none"> <li>- High superheat at the evaporator outlet: this is likely in case of excessive pressure-drop in the liquid line or too much vertical lift on the pipe work.</li> <li>- Low superheat at the evaporator outlet is usually the consequence of oversized selection of the expansion valve or incorrect bulb sensor mounting. The valve may freeze up in the open position due to accumulation of debris in the system. For a system with very short refrigeration lines an accumulator is recommended.</li> </ul> </li> </ul>
	Compressor operating outside the design limits	Check the compressor suction and discharge pressures while it is running. Make sure they are within the operating envelope.
	Defective motor protector	If all operating conditions are normal, the voltage supply at the compressor terminals is balanced and within limits, the compressor crankcase temperature is within normal limits, and the amperage drawn is within the specified range, the motor protector may be defective.

Safety instructions

Product description

Installation

Electrical connection

Starting up & operation

Maintenance & repair

Trouble-shooting

Dismantling & disposal

References

# Copeland Scroll™

Condition	Cause	Corrective action
Excessive discharge temperature	Too high compressor superheat	Make sure the compressor operates within the acceptable superheat range published by Emerson.
The Scroll compressor runs continuously	Excessive cooling / heating load or inadequate insulation	Check the load design; make sure that proper insulation is applied. Correct it as necessary.
	Control circuit inoperative	Check the thermostat, measure the temperature of the room and compare with the thermostat; replace or re-calibrate the thermostat. Check the LP control switch and replace it if it is found defective.
Compressor lubrication problem	Oil trap due to incorrect piping layout / sizing	Check the piping layout design. Installations of pipe being routed over or around obstacles can inadvertently create unwanted traps for the oil return. As much as possible the refrigerant line should travel a direct and straight course between the evaporator and compressor. It should also be remembered that the entire system will be coated in oil to some extent. Oil viscosity changes with temperature. More oil stays in the system than was originally expected. Make sure the line is correctly sized.
	Oil pump out due to high cycling rate	A high cycling rate will pump oil into the system and lead to lubrication failure. Oil leaves the compressor at start-up and the short running time is insufficient to return the oil to the compressor via the suction side. Try to limit the number of cycles to maximum 10 per hour.
	Low gas velocity	System gas velocity changes depending on temperature and load (capacity control). In low load conditions gas velocity may not be high enough to return oil to the compressor.
Low discharge pressure	Low ambient temperature	Fit a fan cycling control system.
	Refrigerant undercharge	Check the system for leaks. Observe sight glass for bubbles if fitted. Add refrigerant until the sight glass is clear. If no sight glass is fitted, check the evaporator superheat and fill in with refrigerant.
Low suction pressure	System design load too small	If the compressor is running in a tandem or in parallel, modulate the running process.
	Inadequate refrigerant going to the evaporator	Lower normal discharge pressure values can lead to insufficient refrigerant flow to the system. This can also be verified by checking the evaporator outlet superheat, if it is found unusually high. Check the selection of the expansion valve (likely undersized).
Noise during shut-off	Anti-reverse device	This does not have any effect on the durability of the compressor, no action is necessary.

## 8 Dismantling & disposal



Removing oil and refrigerant:  
Do not disperse in the environment.  
Use the correct equipment and method of removal.  
Dispose of oil and refrigerant according to national legislation and regulations.  
Dispose of compressor according to national legislation and regulations.

## 9 References

Please visit [www.emersonclimate.eu](http://www.emersonclimate.eu) for free download of Application Guidelines and Technical Information.

### Qualified oils and refrigerants

<http://www.emersonclimatebulletins.com/2010/12/01/93-11-refrigerantlubricants-approved-for-use-in-copeland-compressors/>

### Additional technical information:

[www.emersonclimate.eu](http://www.emersonclimate.eu) (Resources / Product Literature / Scroll Compressors / Technical Documentation)

- CC7.4.1 "Pressure equipment directive applied to Copeland™ brand products"
- C7.9.1 "Motors for Copeland Scroll™ compressors"
- Safety & Assembly Instructions for Copeland™ brand compressors.

### 2D-Drawings and certificates:

[www.emersonclimate.eu](http://www.emersonclimate.eu) (Resources / Product Literature / Scroll Compressors / Technical Documentation)

### Performance and technical data:

The latest version of Copeland brand products Select software with performance data and technical data is available from our website [www.emersonclimate.eu](http://www.emersonclimate.eu).

### Spare parts and accessories:

<http://parts.emersonclimate.eu>

## DISCLAIMER

1. The contents of this publication are presented for informational purposes only and are not to be construed as warranties or guarantees, express or implied, regarding the products or services described herein or their use or applicability.
2. Emerson Climate Technologies GmbH and/or its affiliates (collectively "Emerson"), as applicable, reserve the right to modify the design or specifications of such products at any time without notice.
3. Emerson does not assume responsibility for the selection, use or maintenance of any product. Responsibility for proper selection, use and maintenance of any Emerson product remains solely with the purchaser or end user.
4. Emerson does not assume responsibility for possible typographic errors contained in this publication.



#### BENELUX

Josephinastraat 19  
NL-6462 EL Kerkrade  
Tel. +31 77 324 02 34  
Fax +31 77 324 02 35  
benelux.sales@emerson.com

#### GERMANY, AUSTRIA & SWITZERLAND

Senefelder Str. 3  
DE-63477 Maintal  
Tel. +49 6109 605 90  
Fax +49 6109 60 59 40  
ECTGermany.sales@emerson.com

#### FRANCE, GREECE & MAGHREB

8, Allée du Moulin Berger  
FR-69134 Ecully Cédex  
Tel. +33 4 78 66 85 70  
Fax +33 4 78 66 85 71  
mediterranean.sales@emerson.com

#### ITALY

Via Ramazzotti, 26  
IT-21047 Saronno (VA)  
Tel. +39 02 96 17 81  
Fax +39 02 96 17 88 88  
italy.sales@emerson.com

#### SPAIN & PORTUGAL

C/ LLull, 321 (Edifici CINC)  
ES-08019 Barcelona  
Tel. +34 93 412 37 52  
Fax +34 93 412 42 15  
iberica.sales@emerson.com

#### UK & IRELAND

Unit 17, Theale Lakes Business Park  
Reading, Berkshire RG7 4GB  
Tel: +44 1189 83 80 00  
Fax: +44 1189 83 80 01  
uk.sales@emerson.com

#### SWEDEN, DENMARK, NORWAY & FINLAND

Norra Koxåsvägen 7  
SW-443 38 Lerum  
Tel. +46 725 386486  
nordic.sales@emerson.com

#### EASTERN EUROPE & TURKEY

Pascalstr. 65  
DE-52076 Aachen  
Tel. +49 2408 929 0  
Fax +49 2408 929 525  
easterneurope.sales@emerson.com

#### POLAND

Szturmowa 2  
PL-02678 Warsaw  
Tel. +48 22 458 92 05  
Fax +48 22 458 92 55  
poland.sales@emerson.com

#### RUSSIA & CIS

Emerson LLC  
Dubininskaya str. 53, build. 5, 4th floor  
115054 Moscow, Russia  
Phone: +7 (495) 995 95 59  
Fax: +7 (495) 424 88 50

#### BALKAN

Selska cesta 93  
HR-10 000 Zagreb  
Tel. +385 1 560 38 75  
Fax +385 1 560 38 79  
balkan.sales@emerson.com

#### UKRAINE

Kurenevskiy lane, 12, build. A, office 302  
UA-04073 Kiev  
T +38 044 492 99 24 Ext. 232  
F +38 044 492 99 28  
Andrey.Gladchenko@emerson.com

#### ROMANIA

Tel. +40 374 13 23 50  
Fax +40 374 13 28 11  
Ancuta.Ionescu@Emerson.com

#### MIDDLE EAST & AFRICA

PO Box 26382  
Jebel Ali Free Zone - South, Dubai - UAE  
Tel. +971 4 811 81 00  
Fax +971 4 886 54 65  
mea.sales@emerson.com

#### ASIA PACIFIC

Suite 2503-8, 25/F., Exchange Tower  
33 Wang Chiu Road, Kowloon Bay  
Kowloon, Hong Kong  
Tel: +852 2866 3108  
Fax: +852 2520 6227

C6.2.28/0915/E

For more details, see [www.emersonclimate.eu](http://www.emersonclimate.eu)

Connect with us: [facebook.com/EmersonClimateEurope](https://facebook.com/EmersonClimateEurope)



Emerson Climate Technologies - European Headquarters - Pascalstrasse 65 - 52076 Aachen, Germany  
Tel. +49 (0) 2408 929 0 - Fax: +49 (0) 2408 929 570 - Internet: [www.emersonclimate.eu](http://www.emersonclimate.eu)

The Emerson Climate Technologies logo is a trademark and service mark of Emerson Electric Co. Emerson Climate Technologies Inc. is a subsidiary of Emerson Electric Co. Copeland is a registered trademark and Copeland Scroll is a trademark of Emerson Climate Technologies Inc. All other trademarks are property of their respective owners. Emerson Climate Technologies GmbH shall not be liable for errors in the stated capacities, dimensions, etc., as well as typographic errors. Products, specifications, designs and technical data contained in this document are subject to modification by us without prior notice. Illustrations are not binding.  
© 2015 Emerson Climate Technologies, Inc.



**EMERSON. CONSIDER IT SOLVED.™**