

FCP/1

regulator with microprocessor control

CAREL



① User manual

**LEGGI E CONSERVA
QUESTE ISTRUZIONI**
→ **READ AND SAVE
THESE INSTRUCTIONS** ←



We wish to save you time and money!

We can assure you that the thorough reading of this manual will guarantee correct installation and safe use of the product described.

IMPORTANT WARNINGS



CAREL bases the development of its products on decades of experience in HVAC, on the continuous investments in technological innovations to products, procedures and strict quality processes with in-circuit and functional testing on 100% of its products, and on the most innovative production technology available on the market. CAREL and its subsidiaries nonetheless cannot guarantee that all the aspects of the product and the software included with the product respond to the requirements of the final application, despite the product being developed according to start-of-the-art techniques. The customer (manufacturer, developer or installer of the final equipment) accepts all liability and risk relating to the configuration of the product in order to reach the expected results in relation to the specific final installation and/or equipment. CAREL may, based on specific agreements, act as a consultant for the positive commissioning of the final unit/application, however in no case does it accept liability for the correct operation of the final equipment/system.

The CAREL product is a state-of-the-art product, whose operation is specified in the technical documentation supplied with the product or can be downloaded, even prior to purchase, from the website www.carel.com.

Each CAREL product, in relation to its advanced level of technology, requires setup/configuration/programming/commissioning to be able to operate in the best possible way for the specific application. The failure to complete such operations, which are required/indicated in the user manual, may cause the final product to malfunction; CAREL accepts no liability in such cases.

Only qualified personnel may install or carry out technical service on the product.

The customer must only use the product in the manner described in the documentation relating to the product.

In addition to observing any further warnings described in this manual, the following warnings must be heeded for all CAREL products:

- Prevent the electronic circuits from getting wet. Rain, humidity and all types of liquids or condensate contain corrosive minerals that may damage the electronic circuits. In any case, the product should be used or stored in environments that comply with the temperature and humidity limits specified in the manual.
- Do not install the device in particularly hot environments. Too high temperatures may reduce the life of electronic devices, damage them and deform or melt the plastic parts. In any case, the product should be used or stored in environments that comply with the temperature and humidity limits specified in the manual.
- Do not attempt to open the device in any way other than described in the manual.
- Do not drop, hit or shake the device, as the internal circuits and mechanisms may be irreparably damaged.
- Do not use corrosive chemicals, solvents or aggressive detergents to clean the device.
- Do not use the product for applications other than those specified in the technical manual.

All of the above suggestions likewise apply to the controllers, serial boards, programming keys or any other accessory in the CAREL product portfolio.

CAREL adopts a policy of continual development. Consequently, CAREL reserves the right to make changes and improvements to any product described in this document without prior warning.

The technical specifications shown in the manual may be changed without prior warning.

The liability of CAREL in relation to its products is specified in the CAREL general contract conditions, available on the website www.carel.com and/or by specific agreements with customers; specifically, to the extent where allowed by applicable legislation, in no case will CAREL, its employees or subsidiaries be liable for any lost earnings or sales, losses of data and information, costs of replacement goods or services, damage to things or people, downtime or any direct, indirect, incidental, actual, punitive, exemplary, special or consequential damage of any kind whatsoever, whether contractual, extra-contractual or due to negligence, or any other liabilities deriving from the installation, use or impossibility to use the product, even if CAREL or its subsidiaries are warned of the possibility of such damage.

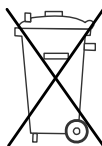

INFORMATION FOR USERS ON THE CORRECT HANDLING OF WASTE ELECTRICAL AND ELECTRONIC EQUIPMENT (WEEE)

In reference to European Union directive 2002/96/EC issued on 27 January 2003 and the related national legislation, please note that:

1. WEEE cannot be disposed of as municipal waste and such waste must be collected and disposed of separately;
2. The public or private waste collection systems defined by local legislation must be used. In addition, the equipment can be returned to the distributor at the end of its working life when buying new equipment.
3. The equipment may contain hazardous substances: the improper use or incorrect disposal of such may have negative effects on human health and on the environment;
4. The symbol (crossed-out wheeled bin) shown on the product or on the packaging and on the instruction sheet indicates that the equipment has been introduced onto the market after 13 August 2005 and that it must be disposed of separately;
5. In the event of illegal disposal of electrical and electronic waste, the penalties are specified by local waste disposal legislation.

Contents

1. Introduction	7
1.1 Main features	7
2. User interface	8
3. Installation	9
4. Programming the instruments	11
4.1 Procedure for setting the double set point by trimmer	11
4.2 Default settings	12
5. Accessories	13
5.1 Parameter copying key	13
5.2 RS485 serial interface board	13
6. Description of the functions	14
6.1 Control modes	14
6.2 Configuring the probes and selecting the range of measurement	14
6.3 Two circuit function	15
6.4 Double set point function	15
6.5 Cut-off function	16
6.6 Output saturation function	16
6.7 Speed-up function	16
6.8 Outside temperature compensation (feedforward function)	17
6.9 PI control (proportional and integral)	17
6.10 Slave mode function	18
6.11 Overriding the output	19
6.12 Phase control modes	19
6.13 Automatic adaptation to the mains frequency	19
6.14 Alarm situations and alarm management	19
7. Description of the operating parameters	20
7.1 Summary table of operating parameters	31
8. Tables of alarms and signals	33
8.1 Alarms	33
8.2 Signals	33
9. Supervision	34
9.1 Carel supervisor protocol	34
9.2 Modbus protocol	34
10. Specifications and connections	36
10.1 FCPM082010 electrical specifications	36
10.2 FCPM082A10 electrical specifications	37
10.3 FCPM082010 connections	37
10.4 FCPM082A10 connections	38
10.5 Dimensions and assembly	38

1. Introduction

The FCP device is a phase control voltage regulator with microprocessor control that is especially suitable for controlling the speed of condensing fans, according to the required pressure/temperature. Alternatively it can be used to control the voltage/power to a resistive or inductive device with a quadratic relationship between load voltage/power.

Two models are available.

- the first is a controller complete with all the functions;
- the second includes the power functions only, and can be used to double the total power available, acting as a slave to the complete controller. Alternatively, it can serve any Carel controller that features a specific phase control output (MCH*, PCO*, ...).

FCPM082010 Controller;
 FCPM082A10 Power expansion.

1.1 Main features

Power supply

The power supply is 230 Vac 50/60Hz mains, with automatic adaptation to the mains frequency.

Appearance and ergonomics

The device has been designed so as to also allow outdoor installation, with specific protection against water and dust.

Management of two circuits

Two circuits can be controlled in parallel, based on the more critical conditions.

Pressure or temperature probes

The following can be used indifferently, by making the suitable settings:

- radiometric pressure probes powered directly by the controller
- NTC temperature probes with different operating ranges

Manual setting or configuration by parameter

The operation of the FCP controller can be set as follows:

- manually, using the trimmers and dialswitches (restricted to the main functions);
- using the internal parameters (via programming key or serial line).

In the first case, the main functions are available for the simple use of the controller and setting by non-specialist personnel.

In the second case, the available functions are increased considerably, allowing maximum operating flexibility.

Control set point and differential

Two set points are available, which can be selected externally, so as to be able to differentiate the operating conditions based on the time of day or a change in situation in general.

Minimum and maximum output

This function is used to set the range of variation of the output and consequently the fan speed, so as to define the minimum possible speed and maximum acceptable noise, depending on the fans used and specification the application.

External alarm management

This is used to force the output to a preset value when a protector is activated or upon receiving an external control signal.

Cut-off

This function is used to stop the fans, resetting the output, when the controlled pressure/ temperature is below a preset value.

Speed-up

This function is used to overcome the inertia of the fans, operating them momentarily at high speed and then slowing down to the actual speed calculated by the controller, allowing very low speed that otherwise could not be achieved when starting from standstill.

Output saturation

This function, irrespective of the speed settings, operates the fans at the maximum speed allowed by the mains voltage when the controlled pressure/temperature exceeds a preset value.

Outside temperature compensation

This function is used to predict the effects of the variation in the outside temperature (air that cools the condenser), by measuring the outside temperature and acting as a consequence (feedforward action), even before the controlled pressure/temperature is affected.

The function is especially useful when control is performed using the temperature rather than the pressure, as temperature probes are intrinsically slower to respond than pressure probes.

PI control (proportional and integral)

This function combines normal proportional control with an integral action that, if correctly set based on the specific operating conditions, allows more accurate pressure/temperature control.

Direct/Reverse control

This function is used to reverse the control logic, switching from Direct mode (an increase in the controlled pressure/temperature increases the value of the output) normally used to control the condensing fan speed, to Reverse mode (an increase in the controlled pressure/temperature decreases the value of the output).

Slave mode

This function is used to disable the internal control algorithm and manage the output directly based on an external signal.

Serial connection

An RS485 serial output is available for connection via two wires plus shield to the supervisor or telemaintenance network that support the Carel supervisor protocol or the Modbus[®] protocol.

Phase control function

The control of the power section can be modified to adapt it to the type of load.

Index of protection

The gasket inside and the materials used to make the case guarantee the controller IP54 index of protection

Fastening

The device is fastened using 4 screws.

CE mark/Electromagnetic compatibility

The FCP controller is compliant with the EU standards on electromagnetic compatibility, while quality and safety are ensured by the CAREL ISO 9001 certified design and production system and by the CE mark on the product.

2. User interface

The status of the controller is displayed using LEDs that are only visible with the cover open.

The LEDs indicate:

- power on;
- serial connection status;
- alarm status.

To set the operation of the controller, 4 trimmers and 4 dipswitches are available for the main functions, while internal parameters are used to set all the other functions. The parameters can be set using the programming key, while access to the parameters for display and setting, as well as access to the variables that represent the status of the controller, is available via serial line.

3. Installation

To install the controller, proceed as follows, with reference to the connection diagrams shown at the end of the manual.



Important: 230 Vac mains voltage present on the board.

The controller may be installed outside but paying attention to the following instructions:

- Connect the power supply:
Fit a 10A T (or lower rating) fuse in the power supply line (live L), based on the maximum current expected.
- Connect the probes and control signals: the probes can be installed at a maximum distance of 10 m from the controller, as long as cables with a minimum cross-section of 1 mm² are used. To improve immunity to disturbance, use shielded cables (connect just one end of the shield to the earth).
- Program the instrument: for a more detailed description see the chapter "Programming the instruments".
- Connect the load: the load should only be connected after having programmed the controller. In this regard, the maximum current indicated in the "technical specifications" must be considered. The load may be made up of multiple fans in parallel, as long as the maximum capacity is not exceeded. If the controller is used in residential environments (IEC-EN55014-1) a shielded cable must be used.
- Connect to the serial network: the controller is fitted with a connector for housing a serial interface board, FCSE00000, for connection to the supervisor network. Use a shielded cable with the shield connected to GNX.

WARNINGS:

The controller must be installed so as to ensure normal cooling, according to the flow of air. Normally, if there are no cooling fans, it is installed vertically, with the cable outlets downwards.

The temperature of the surface the control is mounted on must not exceed 70° C.

The index of protection is guaranteed only if the following precautions are heeded:

- make sure that the cable glands are fitted with the conical part on the inside
- only use one cable with a diameter between 7 and 10 mm in each cable gland.
- pass the cable through the cable gland as shown in Figure 3.a
- if the installation requires a cable with a diameter of less than 7 mm, or more than one cable in the same cable gland, it is the installer's responsibility to guarantee the appropriate index of protection; for example, using a sheath to increase the thickness or to hold the cables together, making sure there are not gaps.

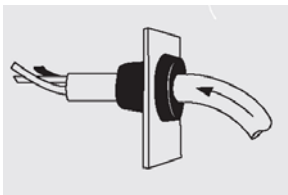

1) Perforate the membrane with the cable or with a screwdriver and push the cable through the hole

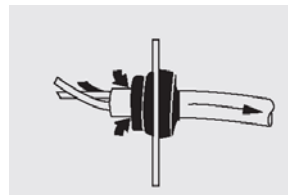

2) Pull the cable slightly backwards to secure it

Fig. 3.a

The power supplies of the FCPM082A10 (power expansion) and the corresponding control device must be connected to the same phases.

Do not use the terminals on the controller to connect the power supply to other devices.

The maximum length of the connection cables is 10m except where specified otherwise.

Size the cross-section of the power wires based on the current input of the load and the length of the cables.

If a shielded cable is used to connect the load, both ends of the shield should be earthed.

On the controller side, the shield should be earthed using a metal cable clamp screwed to the earth bar before the terminals (Fig.3.b).

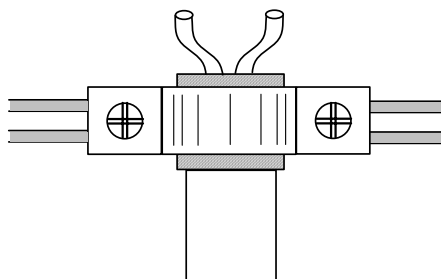

Fig. 3.b

To ensure compliance with the safety standards, the electrical system must be fitted with a suitable switch or disconnecter (compliant with standards IEC 60947-1 and IEC 60947-3), located near the appliance.

If the appliance is used in a manner that is not specified by the manufacturer, the protection featured for the appliance may be compromised and the appliance may be seriously damaged.

Avoid assembling the controllers in environments with the following characteristics:

- relative humidity greater than 90% non-condensing;
- strong vibrations or knocks;
- exposure to continuous water sprays;
- exposure to aggressive or pollutant atmospheres (e.g. sulphur or ammonia fumes, saline mist, smoke) so as to avoid corrosion and oxidation;
- strong magnetic and/or radio interference (for example, near transmitting antennae).

Observe the following warnings when connecting the controllers:

The incorrect connection of the power supply may seriously damage the system.

Use cable ends suitable for the corresponding terminals.

Loosen each screw and insert the cable ends, then tighten the screws and slightly tug the cables to check that they are sufficiently tight;

To tighten the screws, do not use automatic screwdriver, or alternatively adjust to a torque of less than 50 Ncm. If spring terminals are used, compress the spring using a screwdriver, insert the stripped wire then release the spring and slightly tug the cables to check that they are sufficiently tight.

Separate as much as possible (at least 3 cm) the signal cables from the cables carrying inductive loads and power cables to avoid possible electromagnetic disturbance.

Never insert power cables (including the electrical cables) and probe signal cables in the same conduits.

Do not install the probe cables in the immediate vicinity of power devices (contactors, circuit breakers or similar). Reduce the path of the probe cables as much as possible, and avoid spiral paths that enclose power devices. Remember that the NTC temperature probes do not have polarity, and therefore the order the ends are connected is indifferent.

Cleaning the instrument.

When cleaning the instrument do not use ethyl alcohol, hydrocarbons (petrol), ammonia and derivatives.

Use neutral detergents and water.

4. Programming the instruments

The instruments are programmed by dipswitches, trimmers and jumpers, and by setting the internal parameters accessible via programming key or via serial line. The functions that can be set manually are shown in the tables below:

Dipswitch	Function	
Dip1	Select device setting mode	OFF: setting by parameters ON: setting by trimmer
Dip2	Select digital input function	OFF: external alarm (thermal protection activated) ON: set point selection (enable double set point)
Dip3	Enable two circuits	OFF: single circuit (probe B1 only) ON: two circuits (both probes B1 and B2)
Dip4 (NOTE 1)	Enable the function selected by par. DIP4 (default Cut-off)	OFF: function disabled (default) ON: function enabled

Table 4.a

NOTE 1: the position of dipswitch 4 has priority over the parameter that enables the associated function.

Trimmer	Function	Alternative function
SET	Set the set point: 0 -100%	If the double set point is enabled: Set point 1 setting (Dip2 OFF) Save set point 1 (Dip2 OFF → ON) Set point 2 setting (Dip2 ON)
DIF	Set the differential: 0 to 20%	
MIN	Set the minimum output: 0 to 100%	If the feedforward function is enabled: Set the feedforward gain
MAX	Set the maximum output: 0 to 100%	

Configuration	Status of input ID1	Description
ID1=External alarm (Dip2 OFF)	Open	Alarm active
	Closed	Alarm not active
ID1=Double set point (Dip2 ON)	Open	Set point selection 2
	Closed	Set point selection 1

Table 4.b

Digital input ID1 is normally closed by default. A parameter can be set to change the operating logic and manage it as a normally open contact, in which case the meaning of "Open" and "Closed" must be reversed.

If slave mode is enabled, the external control signal is 0/10V. In this case, the controller electrical circuits need to be modified using jumper JA and JB, as shown in the table below:

Jumper			
JA, JB	0/10V input configuration (probe B1 input only)	JA on JB off	input for pressure/temperature probes
		JA off JB on	0/10V input

Table 4.c

If the double set point function is used with setting by trimmer, the fact that only one trimmer is available for setting the set point is a clear limitation, which can however be overcome by following the procedure described below.

4.1 Procedure for setting the double set point by trimmer

The value to be used as setpoint1 is initially saved by adjusting the SET trimmer, and then subsequently selected by digital input, after which the SET trimmer is used to establish set point 2. Dip1 is ON (setting by trimmer) and digital input ID1 is assumed as normally closed.

Dip2	Input ID1	description	set point setting
OFF	Closed	alarm not active use the SET trimmer to set the desired value of set point 1	SET trimmer
OFF → ON	Closed	the current value of the SET trimmer is saved in non-volatile memory (parameter "STPM") as set point 1	
ON	Closed	set point selection 1	parameter "STPM"
ON	Open	set point selection 2 Use the SET trimmer to set the desired value of set point 2	SET trimmer (set point 2)
ON	Closed	set point selection 1	parameter "STPM"
ON	Open	set point selection 2	SET trimmer (set point 2)

Table 4.d

To modify the value of setpoint1, repeat the sequence from the start.

Warning: when Dip2 is OFF, the digital input must be closed, otherwise the alarm condition and corresponding output voltage setting have priority over the set point and consequently the fan speed will not reflect the value set by the trimmer.

4.2 Default settings

The functions that are available by setting the parameters are mostly disabled by default, as they need to be set based on the specific application.

Set the set point, differential, minimum and maximum output	by trimmer (modifiable by dipswitch)
Digital input ID1	external alarm (modifiable by dipswitch)
Two circuit	inactive (modifiable by dipswitch)
Cut-off	inactive (modifiable by dipswitch)
Input B1	Ratiometric pressure probe
Input B2	Ratiometric pressure probe
Input B3	NTC temperature probe 10k Ω
Digital input ID1	Normally closed
Output in the event of alarms	100%
Direct/Reverse control mode	Direct
Slave mode	inactive
Speed-up	active (duration 2 sec)
Output saturation	inactive
Outside temperature compensation (feedforward)	inactive
PI control	inactive
Phase control function	short impulse
Output ramp	1 s
Output linearisation	active

Table 4.e

5. Accessories

5.1 Parameter copying key

Programming key PSOPZKEY00/A0

The programming keys PSOPZKEY00 (Figure 5.1.a) and PSOPZKEYA0 (Figure 5.1.b) are used to copy the complete set of parameters relating to the CAREL FCP controller parameters.

The keys must be connected to the PROG KEY connector (4 pin AMP) fitted on the controllers, and work even without switching the controller on (see the summary diagram in Figure 5.1.c.)



Fig. 5.1.a



Fig. 5.1.b



Fig. 5.1.c

Two functions are available, and are selected by using the two supplied dipswitches; these can be accessed by removing the battery cover:

- load the parameters for a controller onto the key (UPLOAD - Fig. 5.1.d);
- copy from the key to a controller (DOWNLOAD - Fig. 5.1.e);

Warning: the parameters can only be copied between instruments with the same code. The UPLOAD operation can, however, always be performed.

Warning: the parameters can only be copied between instruments with the same code and compatible software release. The UPLOAD operation can, however, always be performed.

The following operations are used for the UPLOAD and/or DOWNLOAD functions, simply by changing the settings of the dipswitches on the key:

- open the rear cover on the key and position the 2 dipswitches according to the desired operation;
- close the rear cover on the key and insert the key in the connector on the controller;
 - press the button and check the LED: red for a few seconds, then green, indicates that the operation was completed correctly.
 - Other signals or the flashing of the LED indicates that problems have occurred: refer to the table below;
- at the end of the operation, release the button, after a few seconds the LED goes OFF;
- remove the key from the controller;



Fig.5.1.d



Fig.5.1.e

LED signal	Cause	Meaning and solution
Red LED flashing	Batteries discharged at start copy	The batteries are discharged, the copy operation cannot be performed. Replace the batteries.
Green LED flashing	Batteries discharged during copy or at end of copy	During the copy operation or at the end of the operation the battery level is low. Replace the batteries and repeat the operation.
Red/green LED flashing (orange signal)	Instrument not compatible	The parameter set-up cannot be copied as the connected controller model is not compatible. This error only occurs for the DOWNLOAD function; check the code of the controller and run the copy only for compatible codes.
Red and green LEDs on	Error in data being copied	Error in the data being copied. The instrument's EEPROM is corrupted, and therefore the key cannot be copied.
Red LED on steady	Data transfer error	The copy operation was not completed due to a serious error when transferring or copying the data. Repeat the operation, if the problem persists check the key connections.
LEDs off	Batteries disconnected	Check the batteries.

Table 5.a

5.2 RS485 serial interface board

The RS485 serial interface option (FCSER00000) shown in Figure 5.2.a – is used to connect the instrument to the RS 485 serial network for supervision.

Figures 5.2.b and 5.2.c show the assembly of the interface in the instrument.

Observe the correct polarity of the connector, making sure the protrusion on the serial board matches the notch on the controller, without forcing the board.

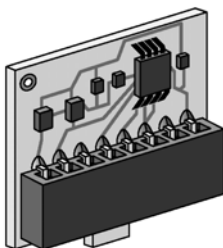

Fig. 5.2.a

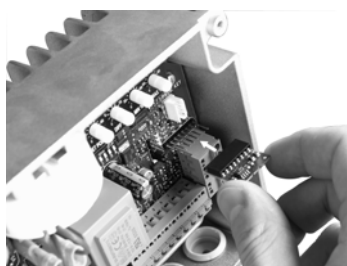

Fig. 5.2.b

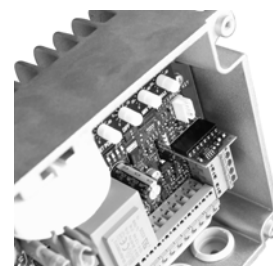

Fig. 5.2.c

6. Description of the functions

6.1 Control modes

The following operating modes can be set:

Direct an increase in the value measured by the probes increases the value of the output;

Reverse an increase in the value measured by the probes decreases the value of the output.

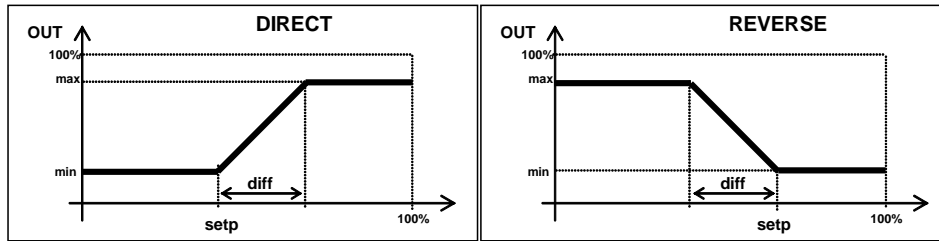

Fig. 6.a

All the functions and observations applied in Direct mode, are valid symmetrically in Reverse mode. Direct mode is set by default (alternatively the selection can be associated with dipswitch 4).

The values of the set point, differential, minimum and maximum output can be set by dipswitch or by setting the parameters.

If the minimum output set is greater than the maximum output, the value is limited internally to maximum output.

The value of the differential is internally limited so as to in any case ensure the maximum output value set is reached (for example if SET+DIF > 100%, DIF is limited to 100%-SET).

Dipswitch	Function	
Dip1	Select device setting mode	OFF: setting by parameters ON: setting by trimmer

Table 6.a.a

Trimmer	Function	
SET	Set the set point	0 – 100%
DIF	Set the differential	0 – 20%
MIN	Set the minimum output	0 – 100%
MAX	Set the maximum output	0 – 100%

Table 6.a.b

Associated parameters

par.	Spv	Modb	range	def	uom	description		
STP1	I4	104	0 to 100	50	1%	Set point (Setpoint1)		
STP2	I5	105	0 to 100	50	1%	Setpoint2		
STPM	I6	106	0 to 100	0	1%	Setpoint1 memory set by trimmer		
DIFF	I7	107	0 to 100	10	1%	Differential		
MIN	I8	108	0 to MAX	30	1%	Minimum output		
MAX	I9	109	MIN to 100	100	1%	Maximum output		
EREV	D1	1	0/1	0	1	Direct/Reverse mode	0 = direct	1 = reverse

Table 6.a.c

6.2 Configuring the probes and selecting the range of measurement

The values of the set point and differential are always internally expressed as a % of the range of measurement used, so as to be able to manage different types of probes at the same time. For ratiometric pressure probes, the range of measurement is the rated value of the probe.

For temperature probes, the range of measurement can be set by parameter and can be limited compared to the maximum rated value of the probes used, so as to improve the resolution of control.

type of NTC probe	maximum range settable by parameter	default range
NTC 10kΩ @25°C	-50 to +90 °C	-10 to + 90 °C
NTC 50kΩ @25°C	0 to +120 °C	+20 to +120 °C

Table 6.a.d

The default range, for both types of probes, has an interval of 100°C so as to simplify the conversion of the set point and above all the differential into a percentage.

The values measured by the probes are digitally filtered to attenuate any external disturbance. The filter can be set by parameter.

Associated parameters

par.	Spv	Modb	range	def	uom	description		
PB1M	I17	117	0 to 3	2	1	Type of probe B1	0 = NTC-10kΩ	3 = 0/10V
PB2M	I18	118	0 to 2	2	1	Type of probe B2	1 = NTC-50kΩ	
PB3M	I19	119	0 to 1	0	1	Type of probe B3	2 = 0/5V ratiometric	
FILT	I23	123	0 to 13	6	1	Probe filter	0 = minimum filter	13 = maximum filter
T0L	A2	2	-50.0 to T0H	-10.0	0.1°C	Lower limit of meas. range NTC-10kΩ corresponding to 0%		
T0H	A3	3	T0L to +90.0	+90.0	0.1°C	Upper limit of meas. range NTC-10kΩ corresponding to 100%		
T1L	A4	4	0.0 to T1H	+20.0	0.1°C	Lower limit of meas. range NTC-50kΩ corresponding to 0%		
T1H	A5	5	T1L to +120.0	+120.0	0.1°C	Upper limit of meas. range NTC-50kΩ corresponding to 100%		
PB1E	D6	6	0/1	1	1	Enable probe B1	0 = disabled	1 = enabled
PB2E	D7	7	0/1	1	1	Enable probe B2	0 = disabled	1 = enabled
PB3E	D8	8	0/1	0	1	Enable probe B3	0 = disabled	1 = enabled

Table 6.a.e

Status variables associated with the probes

par.	Spv	Modb	range	def	uom	description		
PB1R	I35	135	0 to 100	R	1%	probe B1 reading as a % of the range of measurement		
PB2R	I36	136	0 to 100	R	1%	probe B2 reading as a % of the range of measurement		
PB1T	A11	11	-50.0 to +150.0	R	0.1°C	probe B1 temperature reading (temp. probe only)		
PB2T	A12	12	-50.0 to +150.0	R	0.1°C	probe B2 temperature reading (temp. probe only)		
PB3T	A13	13	-50.0 to +150.0	R	0.1°C	probe B3 temperature reading		
PB1A	D23	23	0/1	R	1	probe B1 fault alarm	0=inactive	1=active
PB2A	D24	24	0/1	R	1	probe B2 fault alarm	0=inactive	1=active
PB3A	D25	25	0/1	R	1	probe B3 fault alarm	0=inactive	1=active

Table 6.a.f

6.3 Two circuit function

If this function is enabled, control depends on:

- the higher of the values read by probes B1 and B2 if Direct mode is set;
- the lower of the values read by probes B1 and B2 if Reverse mode is set.

If disabled, control only depends on the value ready by probe B1, and the B2 probe input can remain unused without causing probe alarms.

The function is enabled by dipswitch, but probe B2 must also be enabled by parameter.

By default probes B1 and B2 are enabled by parameter, but the function is disabled by dipswitch and only probe B1 is used. **Warning:** if both probes B1 and B2 are disabled, the controller forces the output either to the minimum value or to zero, according to the setting of the Cut-off function.

Dipswitch	Function		
Dip3	Enable two circuits	OFF:	single circuit (probe B1 only)
		ON:	two circuits (both probes B1 and B2)

Table 6.a.g

Associated parameters

par.	Spv	Modb	range	def	uom	description		
PB1E	D6	6	0/1	1	1	Enable probe B1	0=disabled	1=enabled
PB2E	D7	7	0/1	1	1	Enable probe B2	0=disabled	1=enabled

Table 6.a.h

6.4 Double set point function

This is used to allow two different set points, and switch from one to the other based on an external control signal. The function can be enabled by dipswitch. In this case, the digital input is used to select setpoint1 or setpoint2. If set by trimmer, the physical limitation of having just one trimmer to set the set point can be overcome using the procedure described in the paragraph "Procedure for setting the double set point by trimmer".

Dipswitch	Function		
Dip2	Select digital input function	OFF:	external alarm (thermal protection activated)
		ON:	set point selection (enable double set point)

Table 6.a.i

Configuration	Status of input ID1	description
ID1=Double set point (Dip2 ON)	Open	Set point selection 2
	Closed	Set point selection 1

Table 6.a.j

Trimmer	Function	alternative function
SET	Set the set point 0 -100%	If the double set point is enabled: Set the set point 1 (Dip2 OFF) Save set point 1 (Dip2 OFF → ON) Set the set point 2 (Dip2 ON)

Table 6.a.m

Associated parameters

par.	Spv	Modb	range	def	uom	description		
STP1	I4	104	0 to 100	50	1%	Set point (Setpoint1)		
STP2	I5	105	0 to 100	50	1%	Setpoint2		
STPM	I6	106	0 to 100	0	1%	Setpoint1 memory set by trimmer		
MOID	D11	11	0/1	0	1	Operating logic of digital input ID1	0=normally closed	1=normally open

Table 6.a.n

The value of set point1 by trimmer (par. STPM), in addition to the manual procedure, can also be set directly by parameter, as for all the other parameters.

6.5 Cut-off function

When the output of the controller decreases until reaching the minimum value set, the output is forced to zero and remains at this value until the conditions require an output value that is greater than or equal to the minimum value set.

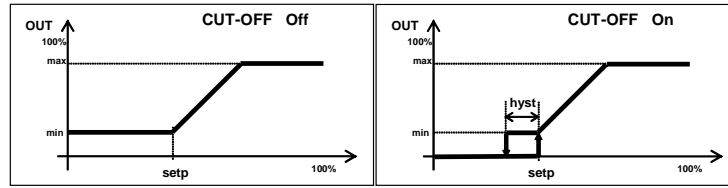

Fig. 6.b

The change from the minimum output to zero output and vice-versa is performed using an hysteresis, so as to avoid unwanted fluctuations. The hysteresis can be set by parameter (default 2% of the operating range of the probes)

By default the function is associated with the position of dipswitch 4.

Dipswitch	Function
Dip4	enable the function selected by par. DIP4 (default Cut-off)
	OFF: function disabled (default)
	ON: function enabled

Table 6.a.o

The status of dipswitch 4 has priority over the parameter that enables the associated function.

Associated parameters

par.	Spv	Modb	range	def	uom	description	
ECOF	D3	3	0/1	0	1	Cut-off function	0=disabled 1=enabled
COFH	I12	112	2 to 100	2	1%	Cut-off activation hysteresis	
DIP4	I20	120	0 to 8	1	1	Function associated with dipswitch 4	0=no function 1=Cut-off 2=Speed-up 3=Output saturation 4=Long impulse phase control 5=Reverse mode 6=Slave mode 1 7=Slave mode 2 8=Slave mode 3

Table 6.a.p

6.6 Output saturation function

If the maximum output set is less than the maximum possible (100% is equivalent to the full mains voltage), when the control output increases until reaching the maximum value set, the output is forced to the maximum possible and remains there until the conditions require an output value that is less than or equal to the maximum value set. The change from the maximum output set to maximum output possible and vice-versa is performed using an hysteresis, so as to avoid unwanted fluctuations. The hysteresis is 2% of the operating range of the probes. By default the function is disabled (alternatively, its status can be set using dipswitch 4).

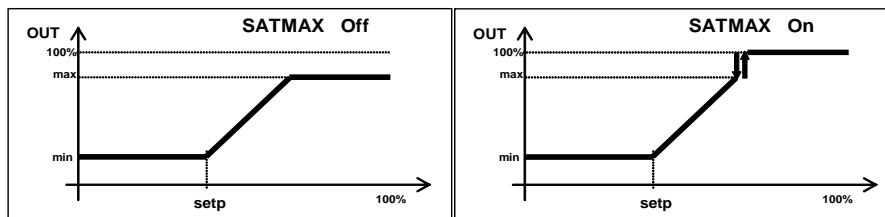

Fig. 6.c

Associated parameters

par.	Spv	Modb	range	def	uom	description	
ESMX	D4	4	0/1	0	1	Saturation function	0=disabled 1=enabled

Table 6.a.q

6.7 Speed-up function

When the output of the controller changes from zero to value greater than or equal to the minimum value set, the output is forced to the maximum value possible for a time set by parameter (default 2 seconds). At the end of this time, the output returns to the required value, following the set ramp. The function has the purpose of overcoming the inertia of the fans, allowing them to operate at low speeds that otherwise would not be possible when starting from standstill. By default the function is enabled (alternatively, its status can be set using dipswitch 4).

Associated parameters

par.	Spv	Modb	range	def	uom	description	
SUPT	I13	113	1 to 5	2	1sec	Speed-up duration	
STEP	I24	124	0 to 10	1	1sec	Output ramp (minimum time for variation from 0% to 100%)	
ESUP	D2	2	0/1	1	1	Function Speed-up	0=disabled 1=enabled

Table 6.a.r

6.8 Outside temperature compensation (feedforward function)

The operation of the controller can be modified according to the temperature measured by probe B3, proportionally increasing the minimum output value set. This function is especially useful when probes B1 and B2 measure temperature values because, as temperature probes are intrinsically slower to respond than pressure probes, it brings forward the effects of any changes in the outside temperature, increasing the output as the outside temperature increases. The maximum value of the reference outside temperature and the intensity of compensation (gain of the feedforward function) can be set by parameter (default 50°C and 50% respectively).

The outside temperature below which the compensation function is deactivated is 0°C.

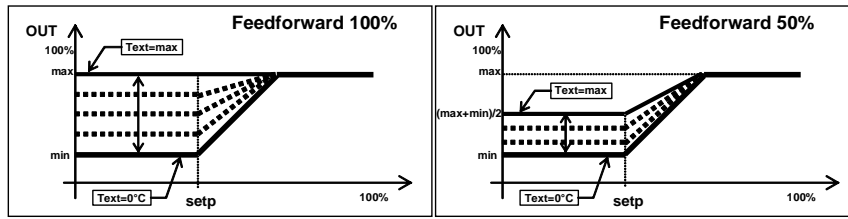

Fig. 6.d

In the event of faults on probe B3, the controller considers the worst case scenario, that is, the maximum outside temperature. When set by trimmer, the MIN trimmer is no longer used to set the minimum output (the minimum output value is taken from the parameter), but rather is used to set the gain for the feedforward function. The effective minimum output calculated varies proportionally to the temperature read by probe B3, between the minimum value set by parameter and a maximum value taken from the formula:

$$OUTminH = (OUTmax - OUTmin) \times KFF/100 + OUTmin$$

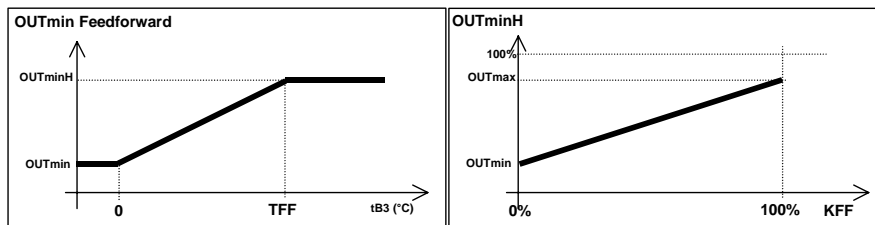

Fig. 6.e

The function is enabled when probe B3 is enabled. By default probe B3 is disabled and consequently so is the function.

Trimmer	function	
MIN	Feedforward gain setting	0 to 100%

Table 6.a.s

Associated parameters

MIN	I8	108	0 to MAX	30	1%	Minimum output		
KFF	I14	114	0 to 100	50	1%	Feedforward function gain		
TFF	A1	1	0.0 to +100.0	+50.0	0.1°C	Max. reference outside temperature for feedforward function		
PB3E	D8	8	0/1	0	1	Enable probe B3	0=disabled	1=enabled

Table 6.a.t

6.9 PI control (proportional and integral)

In addition to the normal contribution of proportional control, the output is also controlled using the integral time on the error (deviation between the value measured and set point).

This is used to reduce the error to zero.

$$out = Kp \cdot err + Ki \cdot Integral(err)$$

where err=error, Kp=proportional gain, Ki=integral gain, Ti=integral time, given by:

$$err = (measure - set\ point)$$

$$Kp = (max - min)/diff$$

$$Ki = Kp/Ti$$

By definition the integral time is the time required, when the error is constant, for the integral part to have the same contribution as the proportional part. The integral time can be set by parameter (default 10 minutes). The contribution of the integral part can be reduced so as to avoid the phenomenon of "wind-up" (default 50%), however in this case the error will not be removed in steady operation. Special care is required when setting the Ti, as excessively short times (see the inertia of the system) may lead to instability. For a more detailed explanation of integral control, see the documents available on control theory.

When integral control is enabled, the output has values that are higher than the minimum output even if the value measured is less than the set point. Specifically, if the Cut-off function is enabled, the output is forced to zero only when the output decreases until reaching the minimum value set (which certainly occurs for values < (Set point - Differential)).

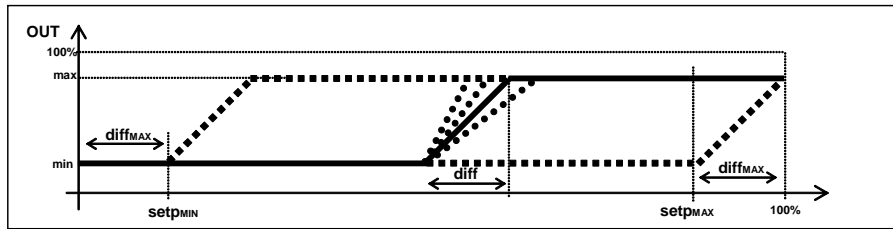

Fig. 6.f

In this regard, it is good practice for the operating range of the probes to allow the set point to be set away from the extremes, by a value greater than the maximum differential envisaged. For example, if the differential being set does not exceed 20%, set point should not be outside of the interval 20% to 80%.

Associated parameters

par.	Spv	Modb	range	def	uom	description	
INTT	I15	115	1 to 30	10	1 min	Integral time for PI control	
AWUP	I16	116	0 to 100	50	1%	Limitation of the integral action (antiwind-up)	
EPIR	D5	5	0/1	0	1	0 = disabled	1 = enabled

Table 6.a.u

To simplify the fine-tuning of the parameters, some variables that are available that describe the status of control in terms of the various components:

ERRR	I38	138	-255 to 255	R	1	control error (255 = 100%)	
OUTP	I39	139	-255 to 255	R	1	proportional component (255 = 100%)	
OUTI	I40	140	-255 to 255	R	1	integral component (255 = 100%)	
OUTM	I41	141	0 to 255	R	1	minimum component (255 = 100%)	
OUTR	I42	142	0 to 255	R	1	control output (255 = 100%)	

Table 6.a.v

The values are expressed with the maximum resolution possible (8 bits plus sign), therefore the value 255 corresponds to 100%.

6.10 Slave mode function

The control algorithm is disabled and the output of the controller is directly proportional to input probe B1, in one of the three modes that can be selected by parameter (alternatively, its status can be set using dipswitch 4).

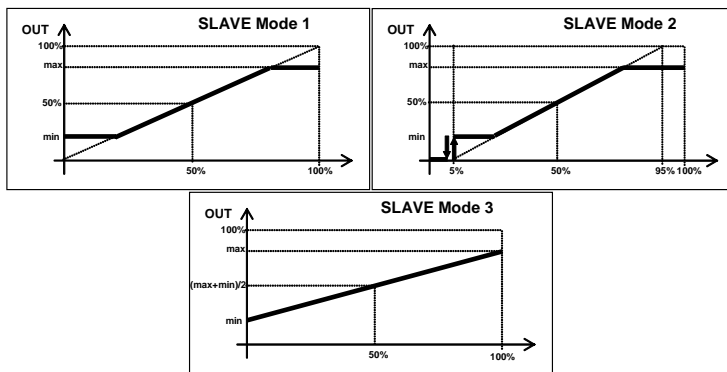

Fig. 6.g

Normally the control signal is supplied by an external controller using the 0/10V standard, however any signal compatible with those allowed for probe input B1 can be used, setting the input accordingly.

Warning: if the control signal applied to probe input B1 is 0/10V, the setting must be made by manually moving a jumper.

With probe input B1 set for a 0/10V signal, the fault probe can no longer be managed. When the function is active, probe input B2 is not managed, irrespective of its setting.

The function is disabled by default.

Jumper			
JA, JB	0/10V input configuration (probe input B1 only)	JA on JB off	input for pressure/temperature probes
		JA off JB on	0/10V input

Table 6.a.z

Associated parameters

par.	Spv	Modb	range	def	uom	description	
MODE	I10	110	0 to 3	0	1	Control mode 0 = standard control; 1 = slave mode 1 2 = slave mode 2 3 = slave mode 3	
PB1M	I17	117	0 to 3	2	1	Type of probe B1	0 = NTC-10kΩ 1 = NTC-50kΩ 2 = ratiometric 0/5V 3 = 0/10V

Table 6.b.a

6.11 Overriding the output

The output can be forced to the desired value required at any time via serial line, irrespective of the value calculated by the controller. This function is temporary and is not saved; it is disabled automatically 10 seconds after the termination of the serial connection.

Associated parameters

par.	Spv	Modb	range	def	uom	description		
OUTV	I37	137	0 to 100	R/W	1%	reading/Override output		
EOVR	D15	15	0/1	0	1	Enable override output	0=disabled	1=enabled

Table 6.b.b

6.12 Phase control modes

By default control is based on short impulses (around 3ms). Alternatively, control can be enabled for long impulses (control is maintained until the end of the half period).

The displacement of the phase control function can also be changed with reference to the zero-crossing of the mains voltage, so as to adapt it to the cos-φ of the fan.

The linearisation of the output RMS voltage can also be enabled, rather than use the traditional sinusoidal relationship between phase control and voltage.

Finally, the instant variation in the output can be limited so as to improve the behaviour of the fan, especially when starting from standstill.

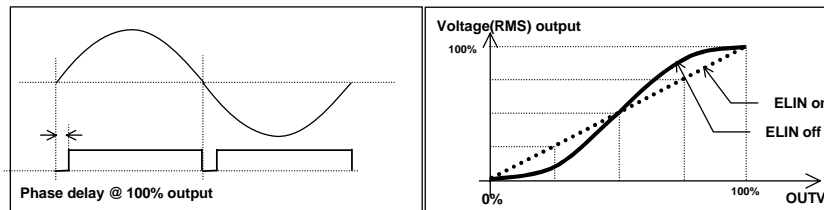

Fig. 6.h

Associated parameters

par.	Spv	Modb	range	def	uom	description		
DLPL	I21	121	0 to 100	10	1%	Phase displacement (100% -> 90°)		
STEP	I24	124	0 to 10	1	1sec	Output ramp (minimum time for variation from 0% to 100%)		
ELIN	D9	9	0/1	1	1	Enable output linearisation	0=disabled	1=enabled
ELPL	D10	10	0/1	0	1	Enable long impulse phase control	0=disabled	1=enabled

Table 6.b.c

6.13 Automatic adaptation to the mains frequency

At power-on the mains frequency is measured so as to adapt operation to 50Hz or 60Hz

The status of the mains frequency reading is accessible via serial line.

par.	Spv	Modb	range	def	uom	description		
OKHZ	D26	26	0/1	R	1	mains frequency reading status	0=not ok	1=ok
STHZ	D27	27	0/1	R	1	mains frequency	0=50Hz	1=60Hz

Table 6.b.d

6.14 Alarm situations and alarm management

Alarm status is activated in the event of:

- activation of the thermal protector (or in any case, the opening of the contact connected to the digital input configured as the alarm input);
- fault on probes B1 or B2;
- error reading/writing the parameters saved in non-volatile memory (EEPROM).

The alarm status is signalled by the red LED, depending on the causes, in order of priority:

- on steady parameter alarm
- 1 impulse probe alarm
- 2 impulses digital input open alarm

In the event of more than one alarm at the same time, the signal with the highest priority is shown.

Warning: if digital input ID1 is set as normally open, the alarm is active when ID1 is closed.

The probe fault alarm is generated if the probe is disconnected or short-circuited. Only the probes enabled by parameter and/or dipswitch are managed (probe B1 is enabled by default, while probe B2 can be enabled by dipswitch).

In alarm status, the controller output provides one of three possible voltage values, with reference to the mains voltage, which can be set by parameter: 0%; 50%; 100% (default).

Normal operation is restored automatically as soon as the alarm situation is resolved. In the event of alarms due to errors when reading/writing the parameters, the parameters take the default values. The alarm is reset only when a correct parameter copy operation is performed using the key or the parameters are written from the supervisor.

If the alarm persists, the EEPROM is faulty.

Dipswitch	Function	OFF:	ON:
Dip2	Select digital input function	external alarm (thermal protection activated)	set point selection (enable double set point)
Dip3	Enable two circuits	single circuit (probe B1 only)	two circuits (both probes B1 and B2)

Table 6.b.e

Associated parameters

par.	Spv	Modb	range	def	uom	description			
ALMO	I11	111	0 to 2	2	1	Output in alarm status	0=0%	1=50%	2=100%
PB1E	D6	6	0/1	1	1	Enable probe B1	0=disabled	1=enabled	
PB2E	D7	7	0/1	1	1	Enable probe B2	0=disabled	1=enabled	
MOID	D11	11	0/1	0	1	Operating logic of digital input ID1	0=normally closed	1=normally open	

Table 6.b.f

7. Description of the operating parameters

MAC	type of unit	
	type and Carel supervisor address	integer var. 1 (read only)
	Modbus address	read register 101
	resolution and unit of measure	1
	range	141
	default	141

Non-modifiable parameter used to identify the type of controller in supervision network connections or when connected to the programming key.

REL	software release	
	type and Carel supervisor address	integer var. 2 (read only)
	Modbus address	read register 102
	resolution and unit of measure	1
	range	0 to 255
	default	--

Non-modifiable parameter used to identify the software version installed on the controller. The least significant digit is used to identify functional variations that do not imply changes to the parameter structure. The parameters can only be copied using the programming key between FCP controllers if the REL parameter has the same value or differs only as regards the least significant digit (for example: the parameters can be copied between controllers with REL 12 and 14, while they cannot be copied between controllers with REL 12 and 20).

SADR	serial address	
	type and Carel supervisor address	integer var. 3
	Modbus address	read/write register 103
	resolution and unit of measure	1
	range	1 to 255
	default	1

Parameter used to identify the individual controller, so as to make it accessible within the supervision network.

STP1	set point (setpoint1)	
	type and Carel supervisor address	integer var. 4
	Modbus address	read/write register 104
	resolution and unit of measure	1%
	range	0 to 100
	default	50

Parameter used to set the value of the control set point (setpoint1 if the double set point function is enabled).

Expressed as a % of the full scale of the probes used.

Only used if: configuration by parameter rather than by trimmer is enabled.

STP2	set point 2	
	type and Carel supervisor address	integer var. 5
	Modbus address	read/write register 105
	resolution and unit of measure	1%
	range	0 to 100
	default	50

Parameter used to set the value of control setpoint2. Expressed as a % of the full scale of the probes used. Only used if:

- the double set point function is enabled;
- configuration by parameter rather than by trimmer is enabled.

STPM	setpoint1 memory by trimmer	
	type and Carel supervisor address	integer var. 6
	Modbus address	read/write register 106
	resolution and unit of measure	1%
	range	0 to 100
	default	0

Parameter used to save the value of control setpoint1 when set by trimmer. The current value of the SET trimmer is saved to STPM when dipswitch 2 is switched from OFF to ON.

Expressed as a % of the full scale of the probes used.

Only used if:

- the double set point function is enabled;
- configuration by trimmer rather than by parameters is enabled.

DIFF	differential	
	type and Carel supervisor address	integer var. 7
	Modbus address	read/write register 107
	resolution and unit of measure	1%
	range	0 to 100
	default	10

Parameter used to set the value of the control differential. Expressed as a % of the full scale of the probes used. Only used if configuration by parameter rather than by trimmer is enabled.

The effective value of the differential is internally limited to the value:

- 100- effective set point in Direct mode;
- effective set point in Reverse mode.

so as to guarantee that the maximum output is reached.

MIN	minimum output	
	type and Carel supervisor address	integer var. 8
	Modbus address	read/write register 108
	resolution and unit of measure	1%
	range	0 to MAX
	default	30

Parameter used to set the minimum output value of the controller.

Expressed as a % of the mains voltage.

Only used if: configuration by parameter rather than by trimmer is enabled.

MAX	maximum output	
	type and Carel supervisor address	integer var. 9
	Modbus address	read/write register 109
	resolution and unit of measure	1%
	range	MIN to 100
	default	100

Parameter used to set the maximum output value of the controller.

Expressed as a % of the mains voltage.

Only used if: configuration by parameter rather than by trimmer is enabled

MODE	slave mode	
	type and Carel supervisor address	integer var. 10
	Modbus address	read/write register 110
	resolution and unit of measure	1
	range	0 to 3
	default	0

Parameter used to enable slave mode.

- MODE=0 slave mode disabled; normal operation of the controller;
- MODE=1 slave mode 1 enabled;
- MODE=2 slave mode 2 enabled;
- MODE=3 slave mode 3 enabled;

For a detailed description of operation in the various modes, see the paragraph "Function slave mode".

ALMO	output in alarm status	
	type and Carel supervisor address	integer var. 11
	Modbus address	read/write register 111
	resolution and unit of measure	1
	range	0 to 2
	default	2

Parameter used to set the value of the output in the event of faulty probe alarms or external alarm.

- ALMO=0 output 0%;
- ALMO=1 output 50%;
- ALMO=2 output 100%.

COFH	Cut-off hysteresis	
	type and Carel supervisor address	integer var. 12
	Modbus address	read/write register 112
	resolution and unit of measure	1%
	range	2 to 100
	default	2

Parameter used to set the amplitude of the activation hysteresis for the Cut-off function.

Warning: the value of hysteresis must be:

- < effective set point in Direct mode
- < 100-effective set point in Reverse mode

otherwise the conditions cannot exist to set the output to zero.

SUPT	Speed-up duration
type and Carel supervisor address	integer var. 13
Modbus address	read/write register 113
resolution and unit of measure	1s
range	1 to 5
default	2

Parameter used to set the duration of the Speed-up function.

KFF	feedforward gain
type and Carel supervisor address	integer var. 14
Modbus address	read/write register 114
resolution and unit of measure	1%
range	0 to 100
default	50

Parameter used to set the intensity of outside temperature compensation.

Only used if:

- configuration by parameter rather than by trimmer is enabled;
- probe B3 and, as a consequence, the outside temperature compensation function is enabled.

INTT	integral time
type and Carel supervisor address	integer var. 15
Modbus address	read/write register 115
resolution and unit of measure	1min
range	1 to 30
default	10

Parameter used to set the intensity of the integral action in PI control.

Only used if:

- PI control is enabled;
- slave mode is not enabled.

AWUP	integral action limit
type and Carel supervisor address	integer var. 16
Modbus address	read/write register 116
resolution and unit of measure	1%
range	0 to 100
default	50

Parameter used to limit the contribution of the integral action in PI control, with the purpose of avoiding excessive overshoot and delays in the controlled value, in systems whose inertia cannot be accurately defined in advance and therefore when the control function is hard to calibrate (DIFF and INTT). Only used if:

- PI control is enabled;
- slave mode is not enabled.

PB1M	type of probe B1
type and Carel supervisor address	integer var. 17
Modbus address	read/write register 117
resolution and unit of measure	1
range	0 to 3
default	2

Parameter used to select the type of probe or signal connected to input B1.

- PB1M=0 Carel NTC temp. probe 10k Ω @ 25°C (range of measurement -50 to 90 °C)
- PB1M=1 Carel NTC temp. probe 50k Ω @ 25°C (range of measurement 0 to 120 °C)
- PB1M=2 0/5 V ratiometric pressure probe
- PB1M=3 0/10 V signal (the position of jumpers JA & JB also needs to be modified)

PB2M	type of probe B2
type and Carel supervisor address	integer var. 18
Modbus address	read/write register 118
resolution and unit of measure	1
range	0 to 2
default	2

Parameter used to select the type of probe or signal connected to input B2.

- PB1M=0 Carel NTC temp. probe 10k Ω @ 25°C (range of measurement -50 to 90 °C)
- PB1M=1 Carel NTC temp. probe 50k Ω @ 25°C (range of measurement 0 to 120 °C)
- PB1M=2 0/5 V ratiometric pressure probe

PB3M	type of probe B3
type and Carel supervisor address	integer var. 19
Modbus address	read/write register 119
resolution and unit of measure	1
range	0 to 1
default	0

Parameter used to select the type of probe or signal connected to input B3.

- PB1M=0 Carel NTC temp. probe 10k Ω @ 25°C (range of measurement -50 to 90 °C);
- PB1M=1 Carel NTC temp. probe 50k Ω @ 25°C (range of measurement 0 to 120 °C).

DIP4 function associated with dipswitch 4

type and Carel supervisor address	integer var. 20
Modbus address	read/write register 120
resolution and unit of measure	1
range	0 to 8
default	1

Parameter used to select the function enabled/disabled by dipswitch 4 rather than by parameter.

DIP4=0	no function associated		
DIP4=1	Cut-off	OFF: disabled	ON: enabled
DIP4=2	Speed-up	OFF: disabled	ON: enabled
DIP4=3	Output saturation	OFF: disabled	ON: enabled
DIP4=4	Long impulse phase control	OFF: short	ON: long
DIP4=5	Reverse mode	OFF: Direct	ON: Reverse
DIP4=6	Slave mode 1	OFF: normal control	ON: Slave mode 1
DIP4=7	Slave mode 2	OFF: normal control	ON: Slave mode 2
DIP4=8	Slave mode 3	OFF: normal control	ON: Slave mode 3

The value of the parameter normally used to enable the function has no affect if the function is selected by DIP4.

DLPL phase displacement

type and Carel supervisor address	integer var. 21
Modbus address	read/write register 121
resolution and unit of measure	1
range	0 to 100
default	10

Parameter used to set the displacement in the phase control function with reference to the zero crossing of the mains voltage. Used to optimise the operation of the fans, adapting the displacement to the cos-fi of the fan. The maximum value of 100 corresponds to a displacement of around 90°. The output should be forced to 100% and parameter DLPL set accordingly to reach the maximum fan speed.

For resistive loads (cos-fi=1), the displacement should be set to zero.

Warning: the parameter must be set with care, as unsuitable values may cause serious malfunctions of the fan.

SERM serial transmission mode

type and Carel supervisor address	integer var. 22
Modbus address	read/write register 122
resolution and unit of measure	1
range	0 to 1
default	0

Parameter used to set special serial communication operating modes.

SERM=0	Modbus transmission with even parity
SERM=1	Modbus transmission with no parity

FILT probe measurement filter

type and Carel supervisor address	integer var. 23
Modbus address	read/write register 123
resolution and unit of measure	1
range	0 to 13
default	6

Parameter used to set the way the values measured by the probes are filtered.

The values shown are typical and may change according to the mode set (CPU workload).

	time constant (s)	measurement update (s)	measurements/average
FILT=0	0	0.08	8
FILT=1	0	0.15	16
FILT=2	0.15	0.08	8
FILT=3	0	0.3	32
FILT=4	0.3	0.15	16
FILT=5	0	0.6	64
FILT=6	0.6	0.3	32
FILT=7	0.6	0.15	16
FILT=8	1.2	0.6	64
FILT=9	1.2	0.3	32
FILT=10	2.4	0.6	64
FILT=11	2.4	0.3	32
FILT=12	5	0.6	64
FILT=13	10	0.6	64

STEP output ramp

type and Carel supervisor address	integer var. 24
Modbus address	read/write register 124
resolution and unit of measure	1s
range	0 to 10
default	1

Parameter used to set the minimum time for the variation of the output from 0% to 100% and vice-versa.

tSET	SET trimmer setting	
	type and Carel supervisor address	integer var. (read only) 31
	Modbus address	read register 131
	resolution and unit of measure	1%
	range	0 to 100
	default	--

Variable used to read the value set by the trimmer

tDIF	DIF trimmer setting	
	type and Carel supervisor address	integer var. (read only) 32
	Modbus address	read register 132
	resolution and unit of measure	1%
	range	0 to 20
	default	--

Variable used to read the value set by the trimmer

tMIN	MIN trimmer setting	
	type and Carel supervisor address	integer var. (read only) 33
	Modbus address	read register 133
	resolution and unit of measure	1%
	range	0 to 100
	default	--

Variable used to read the value set by the trimmer

tMAX	trimmer MAX setting	
	type and Carel supervisor address	integer var. (read only) 34
	Modbus address	read register 134
	resolution and unit of measure	1%
	range	0 to 100
	default	--

Variable used to read the value set by the trimmer.

PB1R	probe B1 reading in %	
	type and Carel supervisor address	integer var. (read only) 35
	Modbus address	read register 135
	resolution and unit of measure	1%
	range	0 to 100
	default	--

Variable used to read the value measured by probe B1 expressed as a % of the range of measurement.

Range of measurement:

radiometric pressure probes	pressure interval specified by the manufacturer of the probe
Carel NTC temp. probe 10k Ω	temperature range defined by parameters T0L and T0H
Carel NTC temp. probe 50k Ω	temperature interval defined the parameters T1L and T1H
0/10 V signal	0/10V or 0.5/9.5V depending on the slave mode set

PB2R	probe B2 reading in %	
	type and Carel supervisor address	integer var. (read only) 36
	Modbus address	read register 136
	resolution and unit of measure	1%
	range	0 to 100
	default	--

Variable used to read the value measured by probe B2 expressed as a % of the range of measurement.

Range of measurement:

radiometric pressure probes	pressure interval specified by the manufacturer of the probe
Carel NTC temp. probe 10k Ω	temperature range defined by parameters T0L and T0H
Carel NTC temp. probe 50k Ω	temperature interval defined the parameters T1L and T1H

OUTV	read/override output	
	type and Carel supervisor address	integer var. 37
	Modbus address	read/write register 137
	resolution and unit of measure	1%
	range	0 to 100
	default	-

Variable used to read the output value and, if the Override function is enabled, to override it.

ERRR error reading

type and Carel supervisor address	integer var. (read only) 38
Modbus address	read register 138
resolution and unit of measure	1
range	-255 to 255
default	--

Variable used to read the value of the error (difference between the set point and the measurement of the controlled value) calculated by the control algorithm and based on which the proportional and integral components are calculated. The error is calculated as follows:

error = set point - measurement	in Reverse mode
error = measurement - set point	in Direct mode

The value read is the actual value used in the algorithm, expressed in 8 bits plus sign, therefore 255 corresponds to 100% of the end scale of the controlled value.

OUTP proportional component reading

type and Carel supervisor address	integer var. (read only) 39
Modbus address	read register 139
resolution and unit of measure	1
range	-255 to 255
default	--

Variable used to read the value of the proportional component calculated by the control algorithm.

$$\text{OUTP} = \text{ERRR} * K_p$$

- where K_p is the proportional gain defined by: $K_p = (\text{OUT}_{\text{max}} - \text{OUT}_{\text{min}}) / \text{Differential}$.

The value read is the actual value used in the algorithm, expressed in 8 bits plus sign therefore 255 corresponds to 100% of the maximum output voltage.

OUTI integral component reading

type and Carel supervisor address	integer var. (read only) 40
Modbus address	read register 140
resolution and unit of measure	1
range	-255 to 255
default	--

Variable used to read the value of the integral component calculated by the control algorithm.

$$\text{OUTI} = K_i * \text{Integral}(\text{ERRR}) = \text{Integral}(K_i * \text{ERRR})$$

- where K_i is the integral gain defined by: $K_i = K_p / T_i$;

- where T_i is the integral time (parameter INTT).

The value calculated is in any case limited, as an absolute value, by the AWUP parameter.

The value read is the actual value used in the algorithm, expressed in 8 bits plus sign therefore 255 corresponds to 100% of the maximum output voltage.

OUTM minimum output reading

type and Carel supervisor address	integer var. (read only) 41
Modbus address	read register 141
resolution and unit of measure	1
range	0 to 255
default	--

Variable used to read the value of the minimum component calculated by the control algorithm according to the minimum output value set and the outside temperature compensation function. The value read is the actual value used in the algorithm, expressed in 8 bits plus sign therefore 255 corresponds to 100% of the maximum output voltage.

OUTR output reading

type and Carel supervisor address	integer var. (read only) 42
Modbus address	read register 142
resolution and unit of measure	1
range	0 to 255
default	--

Variable used to read the overall value of the output calculated by the control algorithm. During control, this value is the sum of the components OUTP, OUTI and OUTM, limited between 0 and 255.

In the event of active alarms, Speed-up enabled or other conditions that force the output to a preset value, OUTR is not calculated as shown previously, but rather reflects the preset value. If the Override function is enabled, OUTR maintains its normal value, even if the output is set by the OUTV parameter. The value read is the actual value used in the algorithm, expressed in 8 bits plus sign therefore 255 corresponds to 100% of the maximum output voltage.

TFF maximum outside temperature

type and Carel supervisor address	analogue var. 1
Modbus address	read/write register 1
resolution and unit of measure	0.1°C
range	0.0 to 100.0
default	50.0

Parameter used to set the maximum reference temperature for the outside temperature compensation function.

TOL	lower limit of meas. range NTC-10kΩ	
	type and Carel supervisor address	analogue var. 2
	Modbus address	read/write register 2
	resolution and unit of measure	0.1°C
	range	-50.0 to TOH
	default	-10.0

Parameter used to set the lower limit of the range of measurement for NTC-10kΩ probes, corresponding to 0%. The controller converts the temperature reading into a % of the range defined by TOL and TOH. If the actual reading is less than TOL, the controller considers this to be 0%.

TOH	upper limit of meas. range NTC-10kΩ	
	type and Carel supervisor address	analogue var. 3
	Modbus address	read/write register 3
	resolution and unit of measure	0.1°C
	range	TOL to 90.0
	default	90.0

Parameter used to set the upper limit of the range of measurement for NTC-10kΩ probes, corresponding to 100%. The controller converts the temperature reading into a % of the range defined by TOL and TOH. If the actual reading is greater than TOH, the controller considers this to be 100%.

T1L	lower limit of meas. range NTC-50kΩ	
	type and Carel supervisor address	analogue var. 4
	Modbus address	read/write register 4
	resolution and unit of measure	0.1°C
	range	0.0 to T1H
	default	20.0

Parameter used to set the lower limit of the range of measurement for NTC-50kΩ probes, corresponding to 0%. The controller converts the temperature reading into a % of the range defined by T1L and T1H. If the actual reading is less than T1L, the controller considers this to be 0%.

T1H	upper limit of meas. range NTC-50kΩ	
	type and Carel supervisor address	analogue var. 5
	Modbus address	read/write register 5
	resolution and unit of measure	0.1°C
	range	T1L to 120.0
	default	120.0

Parameter used to set the upper limit of the range of measurement for NTC-50kΩ probes, corresponding to 100%. The controller converts the temperature reading into a % of the range defined by T1L and T1H. If the actual reading is greater than T1H, the controller considers this to be 100%.

PB1T	probe B1 reading	
	type and Carel supervisor address	analogue var. (read only) 11
	Modbus address	read register 11
	resolution and unit of measure	0.1°C
	range	-50.0 to 150.0
	default	--

Variable used to read the temperature value in °C measured by probe B1. If the probe selected is not a temperature probe, the value read is 0.

PB2T	probe B2 reading	
	type and Carel supervisor address	analogue var. 12
	Modbus address	read/write register 12
	resolution and unit of measure	0.1°C
	range	-50.0 to 150.0
	default	--

Variable used to read the temperature value in °C measured by probe B2. If the probe selected is not a temperature probe the value read is 0.

PB3T	probe B3 reading	
	type and Carel supervisor address	analogue var. 13
	Modbus address	read/write register 13
	resolution and unit of measure	0.1°C
	range	-50.0 to 150.0
	default	--

Variable used to read the temperature value in °C measured by probe B3.

EREV	enable Reverse mode (Direct/Reverse selection)	
	type and Carel supervisor address	digital var. 1
	Modbus address	read/write coil 1
	resolution and unit of measure	1
	range	0/1
	default	0

Parameter used to select Direct or Reverse mode:

EREV=0 Direct (an increase in the value read by the probes increases the value of the output);

EREV=1 Reverse (an increase in the value read by the probes decreases the value of the output).

The parameter has no meaning if the Direct/Reverse selection is associated with dipswitch 4 (parameter DIP4)

ESUP enable Speed-up

type and Carel supervisor address	digital var. 2
Modbus address	read/write coil 2
resolution and unit of measure	1
range	0/1
default	1

Parameter used to enable the Speed-up function:

ESUP=0	disabled
ESUP=1	enabled

The parameter has no meaning if the enabling of the function Speed-up is associated with dipswitch 4 (par. DIP4).

ECOF enable Cut-off

type and Carel supervisor address	digital var. 3
Modbus address	read/write coil 3
resolution and unit of measure	1
range	0/1
default	0

Parameter used to enable the Cut-off function.

ECOF=0	disabled
ECOF=1	enabled

The parameter has no meaning if the enabling of the Cut-off function is associated with dipswitch 4 (parameter DIP4).

ESMX enable Output saturation

type and Carel supervisor address	digital var. 4
Modbus address	read/write coil 4
resolution and unit of measure	1
range	0/1
default	0

Parameter used to enable the Output saturation function.

ESMX=0	disabled
ESMX=1	enabled

The parameter has no meaning if the enabling of the Output saturation function is associated with dipswitch 4 (par. DIP4).

EPIR enable PI control

type and Carel supervisor address	digital var. 5
Modbus address	read/write coil 5
resolution and unit of measure	1
range	0/1
default	0

Parameter used to enable PI control (proportional + integral).

EPIR=0	disabled;
EPIR=1	enabled.

PB1E enable probe input B1

type and Carel supervisor address	digital var. 6
Modbus address	read/write coil 6
resolution and unit of measure	1
range	0/1
default	1

Parameter used to enable probe input B1. The reading of the probe and any alarms due to probe faults are only activated if the input is enabled.

PB1E=0	disabled
PB1E=1	enabled

PB2E enable probe input B2

type and Carel supervisor address	digital var. 7
Modbus address	read/write coil 7
resolution and unit of measure	1
range	0/1
default	1

Parameter used to enable probe input B2. The reading of the probe and any alarms due to probe faults are only activated if the input is enabled.

PB2E=0	disabled
PB2E=1	enabled

Warning: probe input B2 (used for two circuit applications) can only be enabled if the Two circuit function is also enabled (dipswitch 3 ON).

PB3E enable probe input B3

type and Carel supervisor address	digital var. 8
Modbus address	read/write coil 8
resolution and unit of measure	1
range	0/1
default	0

Parameter used to enable probe input B3 and, as a consequence, the outside temperature compensation function. The reading of the probe and any alarms due to probe faults are only activated if the input is enabled.

PB3E=0	disabled
PB3E=1	enabled

ELIN enable output linearisation

type and Carel supervisor address	digital var. 9
Modbus address	read/write coil 9
resolution and unit of measure	1
range	0/1
default	1

Parameter used to enable the linearisation of the output voltage, compensating the sinusoidal relationship between phase and voltage.

ELIN=0	disabled
ELIN=1	enabled

ELPL select phase control function

type and Carel supervisor address	digital var. 10
Modbus address	read/write coil 10
resolution and unit of measure	1
range	0/1
default	0

Parameter used to select the type of phase control.

ELPL=0	short impulse (around 3ms)
ELPL=1	long impulse (from the moment of switching until the end of the mains half period)

The parameter has no meaning if the selection of the type of phase control is associated with dipswitch 4 (par. DIP4).

MOID operating logic of ID1

type and Carel supervisor address	digital var. 11
Modbus address	read/write coil 11
resolution and unit of measure	1
range	0/1
default	0

Parameter used to select the operating logic of digital input ID1.

MOID=0	normally closed
MOID=1	normally open

EOVR enable Override function

type and Carel supervisor address	digital var. 15
Modbus address	read/write coil 15
resolution and unit of measure	1
range	0/1
default	0

Variable used to enable the Override function and consequently force the output to the value defined by the OUTV parameter, irrespective of the value calculated by the control algorithm

PB3E=0	disabled
PB3E=1	enabled

The variable is forced to zero (Override disabled) on power-up and in any case 10 seconds after no more data is received from the serial line.

FDEF reset parameter default values

type and Carel supervisor address	digital var. 16
Modbus address	read/write coil 16
resolution and unit of measure	1
range	0/1
default	0

Variable used to reset the default values of the parameters.

FDEF=0	no action
FDEF=1	reset default

The value is automatically set back to 0 when the function is activated. It is not saved in the EEPROM.

STID	input ID1 status	
	type and Carel supervisor address	digital var. (read only) 17
	Modbus address	read coil 17
	resolution and unit of measure	1
	range	0/1
	default	--
	Variable used to read the status of digital input ID1.	
	STID=0 open	
	STID=1 closed	
STD1	dipswitch 1 status	
	type and Carel supervisor address	digital var. (read only) 18
	Modbus address	read coil 18
	resolution and unit of measure	1
	range	0/1
	default	--
	Variable used to read the position of dipswitch 1.	
	STD1=0 Off	
	STD1=1 On	
STD2	dipswitch 2 status	
	type and Carel supervisor address	digital var. (read only) 19
	Modbus address	read coil 19
	resolution and unit of measure	1
	range	0/1
	default	--
	Variable used to read the position of dipswitch 2.	
	STD2=0 Off	
	STD2=1 On	
STD3	dipswitch 3 status	
	type and Carel supervisor address	digital var. (read only) 20
	Modbus address	read coil 20
	resolution and unit of measure	1
	range	0/1
	default	--
	Variable used to read the position of dipswitch 3.	
	STD3=0 Off	
	STD3=1 On	
STD4	dipswitch 4 status	
	type and Carel supervisor address	digital var. (read only) 21
	Modbus address	read coil 21
	resolution and unit of measure	1
	range	0/1
	default	--
	Variable used to read the position of dipswitch 4.	
	STD4=0 Off	
	STD4=1 On	
ALRM	alarm status	
	type and Carel supervisor address	digital var. (read only) 22
	Modbus address	read coil 22
	resolution and unit of measure	1
	range	0/1
	default	--
	Variable used to read the status of the alarm.	
	ALRM=0 inactive	
	ALRM=1 active	
	The alarm may be signalled externally, associated with the digital input, or due to a fault on probes B1 or B2.	
PB1A	probe B1 alarm status	
	type and Carel supervisor address	digital var. (read only) 23
	Modbus address	read coil 23
	resolution and unit of measure	1
	range	0/1
	default	--
	Variable used to read the status of the probe B1 fault alarm.	
	PB1A=0 inactive	
	PB1A=1 active	
	The alarm is activated automatically if the value read by probe B1 is outside of the range of possible values, typically due to disconnection or short-circuit. The alarm is only detected if probe B1 is enabled. The alarm is not detected if slave mode is selected.	

PB2A probe B2 alarm status

type and Carel supervisor address	digital var. (read only) 24
Modbus address	read coil 24
resolution and unit of measure	1
range	0/1
default	--

Variable used to read the status of the probe B2 fault alarm.

PB2A=0 inactive
PB2A =1 active

The alarm is activated automatically if the value read by probe B2 is outside of the range of possible values, typically due to disconnection or short-circuit.

The alarm is only detected if probe B2 is enabled.

The alarm is not detected if slave mode is selected.

PB3A probe B3 alarm status

type and Carel supervisor address	digital var. (read only) 25
Modbus address	read coil 25
resolution and unit of measure	1
range	0/1
default	--

Variable used to read the status of the probe B3 fault alarm.

PB3A=0 inactive
PB3A =1 active

The alarm is activated automatically if the value read by probe B3 is outside of the range of possible values, typically due to disconnection or short-circuit. The alarm is only detected if probe B3 is enabled.

The alarm is not detected if slave mode is selected.

OKHZ mains frequency reading status

type and Carel supervisor address	digital var. (read only) 26
Modbus address	read coil 26
resolution and unit of measure	1
range	0/1
default	--

Variable used to read the status relating to the reading of the mains frequency.

OKHZ=0 reading in progress
OKHZ =1 reading completed

At the end of the reading, the variable STHZ signals the frequency, 50 or 60Hz.

STHZ mains frequency

type and Carel supervisor address	digital var. (read only) 27
Modbus address	read coil 27
resolution and unit of measure	1
range	0/1
default	--

Variable used to read the mains frequency detected by the controller.

STHZ=0 50Hz
STHZ=1 60Hz

The value of the variable is only meaningful after the mains frequency has been read by the controller (see parameter OKHZ).

EEPA invalid parameter alarm status

type and Carel supervisor address	digital var. (read only) 28
Modbus address	read coil 28
resolution and unit of measure	1
range	0/1
default	--

Variable used to read the status of the parameter read/write error alarm.

EEPA=0 inactive
EEPA =1 active

7.1 Summary table of operating parameters

name	Carel spv var	Modbus var	range	def.	User value	res. uom	description	
MAC	I1	101	141	R		1	Type of unit	
REL	I2	102	0 to 255	R		1	Software release	
SADR	I3	103	1 to 255	1		1	Serial address (NOTE 1) CAREL PROT. UP TO 207	
STP1	I4	104	0 to 100	50		1%	Set point (Set point1)	
STP2	I5	105	0 to 100	50		1%	Set point 2	
STPM	I6	106	0 to 100	0		1%	Setpoint1 memory set by trimmer	
DIFF	I7	107	0 to 100	10		1%	Differential	
MIN	I8	108	0 to MAX	30		1%	Minimum output	
MAX	I9	109	MIN to 100	100		1%	Maximum output	
MODE	I10	110	0 to 3	0		1	Slave mode	0=standard control; 1=slave mode 1 2=slave mode 2 3=slave mode 3
ALMO	I11	111	0 to 2	2		1	Output in alarm status	0=0% 1=50% 2=100%
COFH	I12	112	2 to 100	2		1%	Cut-off activation hysteresis	
SUPT	I13	113	1 to 5	2		1sec	Speed-up duration	
KFF	I14	114	0 to 100	50		1%	Feedforward gain	
INTT	I15	115	1 to 30	10		1min	Integral time in PI control	
AWUP	I16	116	0 to 100	50		1%	Integral action limitation (antiwind-up)	
PB1M	I17	117	0 to 3	2		1	Type of probe B1	0 = NTC-10kΩ 3 = 0/10V 1 = NTC-50kΩ 2 = 0/5V ratiometric
PB2M	I18	118	0 to 2	2		1	Type of probe B2	
PB3M	I19	119	0 to 1	0		1	Type of probe B3	
DIP4	I20	120	0 to 8	1		1	Select function associated with dipswitch 4	0=no function 1=Cut-off 2=Speed-up 3=Output saturation 4=Long impulse phase control 5=Reverse mode 6=Slave mode1 7=Slave mode2 8=Slave mode3
DLPL	I21	121	0 to 100	10		1%	Phase displacement (100% -> 90°)	
SERM	I22	122	0 to 1	0		1	Serial transmission mode	0= Modbus even parity 1= Modbus no parity
FILT	I23	123	0 to 13	6		1	Probe filter	0= minimum filter 13= maximum filter
STEP	I24	124	0 to 10	1		1sec	Output ramp (minimum time for variation from 0% to 100%)	
	I25 to I30	125 to 130	0	R			not used	
tSET	I31	131	0 to 100	R		1%	SET trimmer reading	
tDIF	I32	132	0 to 20	R		1%	DIF trimmer reading	
tMIN	I33	133	0 to 100	R		1%	MIN trimmer reading	
tMAX	I34	134	0 to 100	R		1%	MAX trimmer reading	
PB1R	I35	135	0 to 100	R		1%	probe B1 reading as a % of the range of measurement	
PB2R	I36	136	0 to 100	R		1%	probe B2 reading as a % of the range of measurement	
OUTV	I37	137	0 to 100	R/W		1%	reading/Override output (NOTA1)	
ERRR	I38	138	-255 to 255	R		1	control error (255 = 100%)	
OUTP	I39	139	-255 to 255	R		1	proportional component (255 = 100%)	
OUTI	I40	140	-255 to 255	R		1	integral component (255 = 100%)	
OUTM	I41	141	0 to 255	R		1	minimum component (255 = 100%)	
OUTR	I42	142	0 to 255	R		1	controller output (255 = 100%)	
	I43 to I50	143 to 150	0	R		1	not used	
TFF	A1	1	0.0 to +100.0	+50.0		0.1°C	Max reference outside temp. for feedforward function	
TOL	A2	2	-50.0 to T0H	-10.0		0.1°C	Lower limit of meas. range NTC-10kΩ corresponding to 0%	
T0H	A3	3	TOL to +90.0	+90.0		0.1°C	Upper limit of meas. range NTC-10kΩ corresponding to 100%	
T1L	A4	4	0.0 to T1H	+20.0		0.1°C	Lower limit of meas. range NTC-50kΩ corresponding to 0%	
T1H	A5	5	T1L to +120.0	+120.0		0.1°C	Upper limit of meas. range NTC-50kΩ corresponding to 100%	
	A6 to A10	6 to 10	0	R		1	not used	
PB1T	A11	11	-50.0 to +150.0	R		0.1°C	probe B1 temperature reading (temp. probe only)	
PB2T	A12	12	-50.0 to +150.0	R		0.1°C	probe B2 temperature reading (temp. probe only)	
PB3T	A13	13	-50.0 to +150.0	R		0.1°C	probe B3 temperature reading	
	A14 to A16	14 to 16	0	R		1	not used	
EREV	D1	1	0/1	0		1	Direct/Reverse mode	0=direct 1=reverse
ESUP	D2	2	0/1	1		1	Speed-up function	0=disabled 1=enabled
ECOF	D3	3	0/1	0		1	Cut-off function	0=disabled 1=enabled
ESMX	D4	4	0/1	0		1	Saturation function	0=disabled 1=enabled
EPIR	D5	5	0/1	0		1	Enable PI control (Integral)	0=disabled 1=enabled
PB1E	D6	6	0/1	1		1	Enable probe B1	0=disabled 1=enabled
PB2E	D7	7	0/1	1		1	Enable probe B2	0=disabled 1=enabled
PB3E	D8	8	0/1	0		1	Enable probe B3	0=disabled 1=enabled
ELIN	D9	9	0/1	1		1	Enable output linearisation	0=disabled 1=enabled

ELPL	D10	10	0/1	0		1	Enable long impulse phase control	0=disabled	1=enabled
MOID	D11	11	0/1	0		1	Operating logic of digital input ID1	0=normally closed	1=normally open
	D12 to D14	12 to 14	0	0		1	not used		
EOVR	D15	15	0/1	0		1	Enable override output (NOTE 2)	0=disabled	1=enabled
FDEF	D16	16	0/1	0		1	Reset default values (NOTE 3)	0=no action	1=enabled
STID	D17	17	0/1	R		1	input ID1 status	0=open	1=closed
STD1	D18	18	0/1	R		1	dipswitch 1 status	0=Off	1=On
STD2	D19	19	0/1	R		1	dipswitch 2 status	0=Off	1=On
STD3	D20	20	0/1	R		1	dipswitch 3 status	0=Off	1=On
STD4	D21	21	0/1	R		1	dipswitch 4 status	0=Off	1=On
ALRM	D22	22	0/1	R		1	alarm status	0=inactive	1=active
PB1A	D23	23	0/1	R		1	probe B1 fault alarm	0=inactive	1=active
PB2A	D24	24	0/1	R		1	probe B2 fault alarm	0=inactive	1=active
PB3A	D25	25	0/1	R		1	probe B3 fault alarm	0=inactive	1=active
OKHZ	D26	26	0/1	R		1	mains freq. reading	0=no ok	1=ok
STHZ	D27	27	0/1	R		1	mains frequency	0=50Hz	1=60Hz
EEPA	D28	28	0/1	R		1	parameter error alarm	0=inactive	1=active
	D29 to D32	29 to 32	0	R		1	not used		

Table 7.a

Key:

A = indicates analogue variables

I = indicates integer variables

D = indicates digital variables

R = indicates read only variables (no default values, as these are initialised/updated automatically at power-on)

NOTE 1:

The parameter should be modified via serial connection with care, as this implies the dynamic management of the address by the Master.

NOTE 2:

The override control is disabled at power-on and when serial communication is interrupted for more than 10 seconds.

NOTE 3:

The value is automatically set back to 0 when the function is activated.

8. Tables of alarms and signals

8.1 Alarms

The alarm status is indicated by the red LED

status of the red LED	description	possible causes of the alarm
off	no alarm	
on	parameter error alarm	non-volatile memory error (EEPROM)
flashing 1 impulse	probe B1 or B2 faulty alarm	probes disconnected or short-circuited
flashing 2 impulses	external alarm	opening of the contact associated with the digital input

Table 8.a

The probe fault alarms are only detected for the probes that are enabled.

If there are multiple alarms activated at the same time, the first in order shown in the table is signalled.

The active alarm status forces the output to the value defined by the ALMO parameter.

The alarm status is available via serial line.

8.2 Signals

Power is signalled by the green LED.

The status of the serial connection is signalled by the yellow LED.

status of the yellow LED	description	possible causes
off	connection deactivated	cable disconnected supervisor off-line protocol not supported
flashing	data reception	data reception with correct protocol
on	connection active	the connection is active, but no data is being received.

Table 8.b

The serial connection is automatically deactivated 10 seconds after the last valid data is received.

9. Supervision

The following protocols are supported in slave mode (response to a query from a Master).

Carel supervisor ver 3.0s

Modbus over serial line V1.0 (specification V1.1a)

Both protocols use the RS485 serial line, with the following settings (11 bit frame):

	Reception	Transmission Carel supervisor	Transmission Modbus	
			SERM=0 (default)	SERM=1
baud rate	19.200			
start	1 bit			
data	8 bit			
parity	1 bit (no check) (NOTE)	no parity (0 bit)	even parity (1 bit)	no parity (0 bit)
stop	1 bit	2 bit	1 bit	2 bit

Table 9.a

The protocol used is recognised automatically. If the controller is connected to a Carel supervisor, the controller will respond with the Carel protocol, similarly if the controller is connected to a Modbus supervisor, the controller will respond with the Modbus protocol.

NOTE:

this allows any type of 11 bit frame to be received, irrespective of whether the penultimate bit is a stop bit or the type of parity.

9.1 Carel supervisor protocol

This allows immediate connection to all Carel devices and supervisory systems that support version 3.0s. For the addresses of the individual variables, see the column "Carel spv var" in the table of parameters.

The variables are grouped into blocks: if a variable in a certain block is modified, the entire block is sent:

integer variables relating to parameters	I1 -- I24
integer status variables	I31 -- I42
analogue variables relating to parameters	A1 -- A5
analogue status variables	A11 -- A13
digital variables relating to parameters	D1 -- D11
digital status variables/commands	D15 -- D28

9.2 Modbus protocol

This allows connection to all the devices and supervisory systems that support Modbus over serial line V1.0 (specification V1.1a).

The table below lists the function codes that are currently supported:

Code	Short description	Description
01 (0x01)	Read Coils	Reads from 1 to 32 consecutive digital variables
02 (0x02)	Read Discrete Inputs	Reads from 1 to 32 consecutive digital variables
03 (0x03)	Read Holding Registers	Reads from 1 to 16 consecutive analogue variables or from 1 to 16 consecutive integer variables
04 (0x04)	Read Input Registers	Reads from 1 to 16 consecutive analogue variables or from 1 to 16 consecutive integer variables
05 (0x05)	Write Single Coil	Writes 1 digital variable
06 (0x06)	Write Single Register	Writes 1 analogue or integer variable
17 (0x11)	Report Slave ID	Returns the MAC identifier and the status of the controller

Table 9.b

The table below lists the Modbus exceptions that are currently supported:

Code	Short description	Description
1	Illegal function	Function code not supported
2	Illegal data address	Address not valid for the Slave
3	Illegal data value	Data not valid for the Slave
4	Slave device failure	An irreversible error has occurred during running of the function code

Table 9.c

9.2.1 Description of the Function codes supported

- 0x01 Read Coils
- 0x02 Read Discrete Inputs

Return from 1 to 32 consecutive digital variables. The use of the two function codes is identical, as no distinction is made between Coils (read/write digital variables) and Discrete Inputs (read only digital variables from I/O devices).

The slave responds with an Exception in the following cases:

- EXCEPTION 2: Address of the first variable requested > 32
 Address of the first variable requested + number of variables requested > 32
- EXCEPTION 3: Number of variables requested > 32

- 0x03 Read Holding Registers
- 0x04 Read Input Registers

Return from 1 to 16 consecutive analogue variables or from 1 to 32 consecutive integer variables.

The use of the two function codes is identical, as no distinction is made between Holding Registers (read/write Registers) and Input Register (read only Registers from I/O devices).

To map the addresses of the analogue and integer variables (according to the standard Carel protocol) in the space of Modbus addresses, the following rule has been defined:

Analogue variables	(Carel range: 1-16)	->	Modbus range: Holding/Input Registers 1-16
Integer variables	(Carel range: 1-50)	->	Modbus range: Holding/Input Registers 101-150

The slave responds with an Exception in the following cases:

- EXCEPTION 2: Address of the first variable requested NOT between 1-16 and 101-150;
 Address of the first variable requested between 1-16 and address of the first variable requested + number of variables requested > 16;
 Address of the first variable requested between 101-150 and address of the first variable requested + number of variables requested > 150;
- EXCEPTION 3: Address of the first variable requested between 1-16 and number of variables requested > 16;
 Address of the first variable requested between 101-150 and number of variables requested > 32;

Note: the maximum number of 32 integer variables that can be sent is determined by the maximum size of the transmission buffer.

- 0x05 Write Single Coil

Writes a digital variable as ON or OFF to the Slave.

The slave responds with an Exception in the following cases:

- EXCEPTION 2: Address of the variable being written > 32;
- EXCEPTION 3: Value being written contained in the Modbus package other than 0x0000 (OFF) or 0xFF00 (ON) (Note: a Write Single Coil package sent by a Master compliant with the Modbus protocol should NEVER generate this exception);
- EXCEPTION 4: The Master has attempted to write a read only digital variable;

- 0x06 Write Single Register

Writes an analogue or integer variable to the Slave.

The slave responds with an Exception in the following cases:

- EXCEPTION 2: Address of the variable being written not between 1-16 and 101-150;
- EXCEPTION 4: The Master has attempted to write a read only analogue or integer variable;
 The Master has attempted to write an analogue or integer value that is outside of the minimum and maximum range;

- 0x11 Report Slave ID

Returns the unit code (MAC parameter), the ON/OFF status of the controller (as there is no standby mode, the controller is always ON) and the FW release (REL parameter).

The slave never responds with an exception.

For the addresses of the individual variables, see the "Modbus var" column in the table of parameters.

10. Specifications and connections

10.1 FCPM082010 electrical specifications

Power supply	230 Vac single-phase. -15% +10% 50/60 Hz
Analogue outputs	1 phase control 0-230 Vac single-phase, 8 A (min 500mA)
Digital outputs	1 phase control function for expansion with auxiliary power devices, MCHRTF* 0-5 V 5 mA max;
Analogue inputs	1 configurable input for - ratiometric pressure probes 0-5V - std Carel NTC temp. probes (10k Ω @25°C) range of measurement: -50°C +90°C - std Carel NTC temp. probes (50k Ω @25°C) range of measurement: 0°C +120°C - 0/10V control (Rin: 20 k Ω) 1 configurable input for - ratiometric pressure probes 0-5V - std Carel NTC temp. probes (10k Ω @25°C) range of measurement: -50°C +90°C - std Carel NTC temp. probes (50k Ω @25°C) range of measurement: 0°C +120°C 1 configurable input for - std Carel NTC temp. probes (10k Ω @25°C) range of measurement: -50°C +90°C - std Carel NTC temp. probes (50k Ω @25°C) range of measurement: 0°C +120°C measurement precision (excluding the probes): - ratiometric probes: 1% - 0/10V control: 5% (typical 2%) - NTC probes 10k Ω : $\pm 1^\circ\text{C}$ [-10/50]; $\pm 2^\circ\text{C}$ [-40/-10 and 50/90] - NTC probes 50k Ω : $\pm 1^\circ\text{C}$ [30/90]; $\pm 2^\circ\text{C}$ [0/30 and 90/120]
Digital inputs	1 input with voltage free contact typical voltage 12 V with contact open, typical current 6 mA with contact closed.
Serial outputs	1 standard RS485 two wire connector [NOTE 1] Carel supervisor and ModBus protocol; baud rate 19200; max length 1 km with shielded cable
Signal lights	Green power LED Red alarm LED Yellow serial connection active LED (flashes when receiving valid frame)
Controller settings	4 trimmers for manually setting: - set point - differential - minimum speed - maximum speed 4 dipswitches: - select manual setting or configuration by parameters - select function associated with the digital input - enable double circuit (probe B2) - enable Cut-off (or other settable function) 2 jumpers: - 0/10V input configuration
Terminals and connectors	Power supply and analogue outputs: Screw terminals for cable cross-section min. 2.5 mm ² max 4 mm ² . Signals: Spring terminals for cable cross-section max 2.5mm ² . 4 pin JST connector for programming key
Operating conditions	-20/+50°C, <90% rH non-condensing
Storage conditions	-20/+70°C, <90% rH non-condensing
Index of protection	IP54
Environmental pollution	2
Protection against electric shock	Class I
PTI of the insulating materials	250V
Period of stress across the insulating parts	Long
Type of action -disconnection	1Y
Category of resistance to heat and fire	Category D (UL94 – V0)
Immunity against voltage surges	Category II
Ageing characteristics	60,000 operating hours
No. of automatic operating cycles	100,000
Software class and structure	Class A
Case	Metallic (Al) with plastic cover (ball pressure test 75°C)
Dimensions	140x135x90 mm
Assembly	Metal case fastened to panel or wall mounted using 4 screws dia. 3.5/4 mm
Certification	EMC: EN 61326-1, EN 55014-1, EN 55014-2 Safety: EN 60730-1

Table 10.a

Note 1:

The FCSER00000 option is required

10.2 FCPM082A10 electrical specifications

Power supply	230 Vac single-phase. -15% +10% 50/60 Hz
Analogue outputs	1 phase control 0-230Vac single-phase, 8A (min 500mA)
Inputs	1 phase control function 0-5V 2mA max;
Signal lights	Green power LED
Terminals and connectors	Power supply and analogue outputs: Screw terminals for cable cross-section min. 2.5 mm ² max 4 mm ² . Signals: Spring terminals for cable cross-section max 2.5mm ² .
Operating conditions	-20/+50°C, <85% rH non-condensing
Storage conditions	-20/+70°C, <85% rH non-condensing
Index of protection	IP54
Environmental pollution	2
Protection against electric shock	Class I
PTI of the insulating materials	250V
Period of stress across the insulating parts	Long
Type of action –disconnection	1Y
Category of resistance to heat and fire	Category D (UL94 – V0)
Immunity against voltage surges	Category II
Ageing characteristics	60,000 operating hours
No. of automatic operating cycles	100,000
Software class and structure	Class A
Case	Metallic (Al) with plastic cover (ball pressure test 75°C)
Dimensions	140x135x90 mm
Assembly	Metal case fastened to panel or wall mounted using 4 screws dia. 3.5/4 mm
Certification	EMC :EN 61326-1, EN 55014-1, EN 55014-2 Safety: EN 60730-1

Table 10.b

10.3 FCPM082010 connections

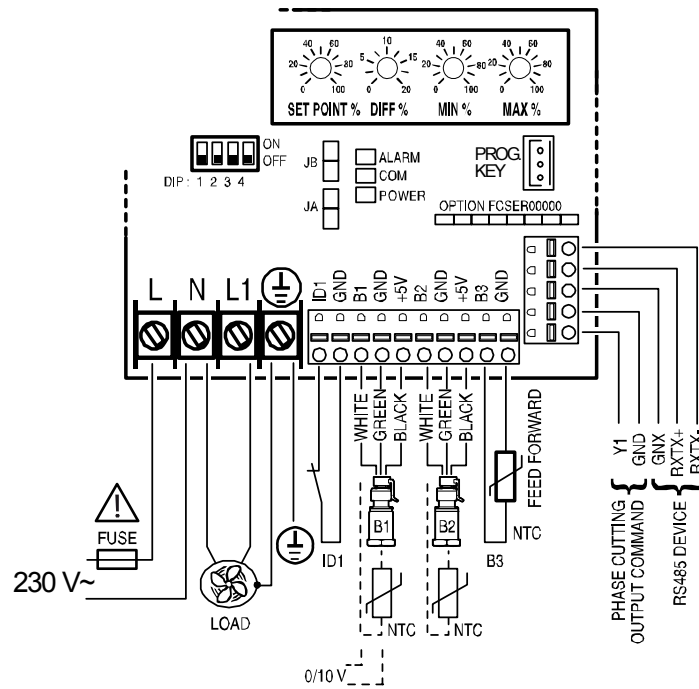

Fig. 10.a

L, N	Controller 230 Vac power supply input
L1, N	Power supply output to 0 to 230 Vac load
ID1, GND	Programmable digital input. Motor protector or second set point management, see dipswitch configuration.
B1, GND, +5V	Analogue input for pressure (ratiometric) or temperature reading (CAREL NTC probe or 0/10 V control) in circuit 1
B2, GND, +5V	Analogue input for pressure (ratiometric) or temperature reading (CAREL NTC probe) in circuit 2
B3, GND	NTC input for temperature reading used in the feed-forward algorithm (CAREL NTC probe)..
GNX, RX+TX+, RX-TX-	RS485 serial with CAREL supervisor or ModBus slave protocol (the FCSER0000 option is required).
Y1, GND	Control output for expansion with auxiliary power device;

10.4 FCPM082A10 connections

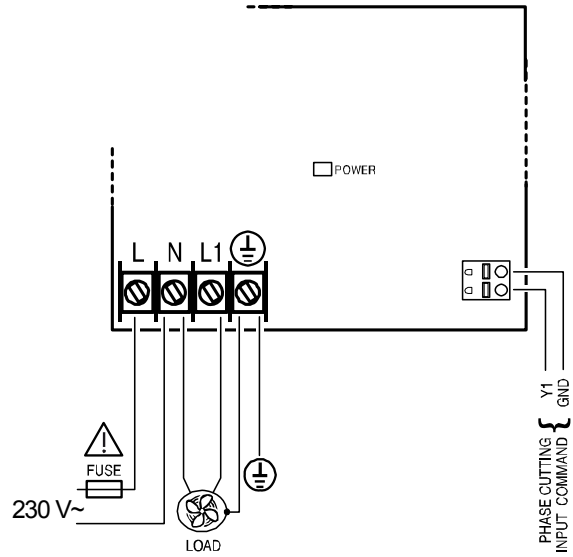

Fig. 10.b

L, N	Controller 230 Vac power supply input
L1, N	Power supply output to 0 to 230 Vac load
Y1, GND	Control input

10.5 Dimensions and assembly

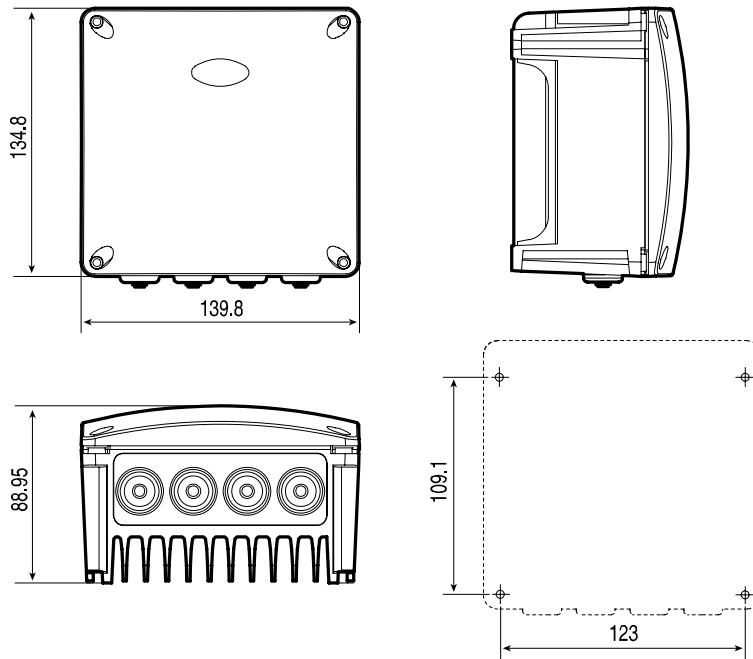

Fig. 10.c

CAREL

Technology & Evolution

CAREL S.p.A.

Via dell'Industria, 11 - 35020 Brugine - Padova (Italy)

Tel. (+39) 049.9716611 Fax (+39) 049.9716600

<http://www.carel.com> - e-mail: carel@carel.com

Agenzia / Agency:

Code: +030220391 Rel. 1.1 - 07/11/06